

! "



\$%& '

\$ " "

" " "" \$%& (# (*+, " -, " .+ ")

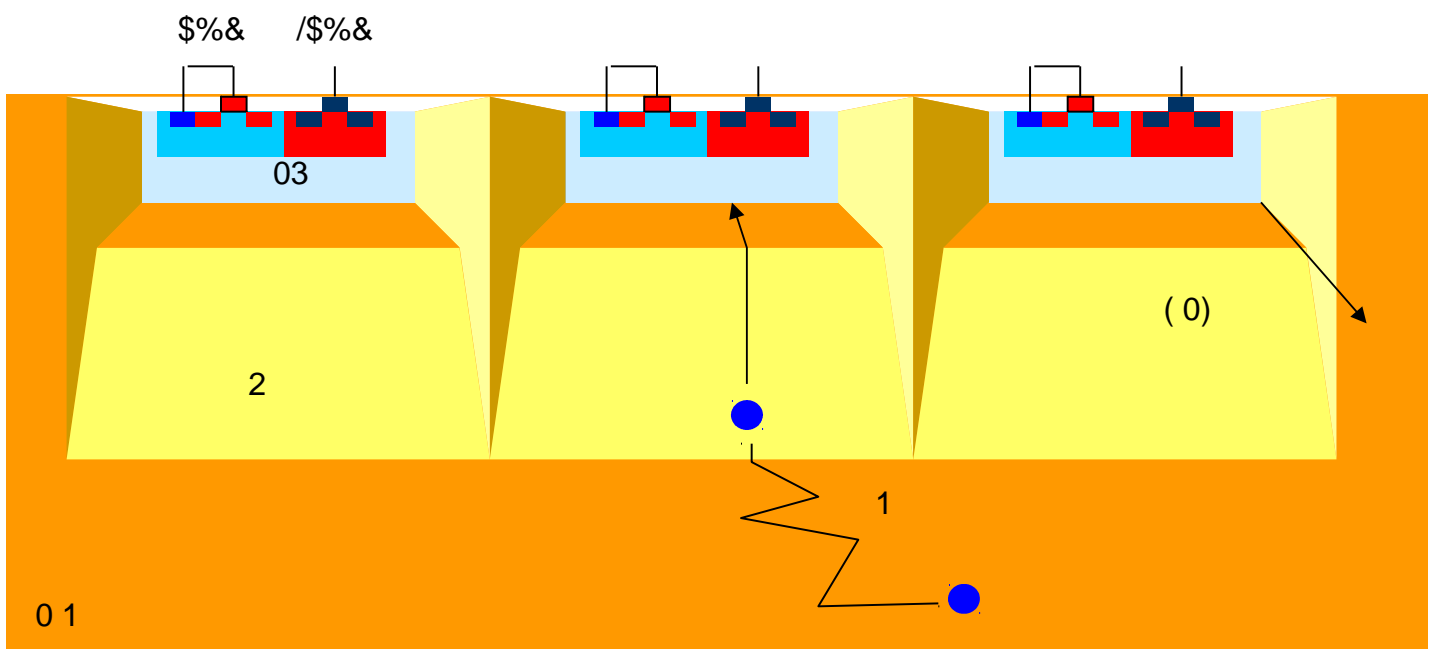



' " 0 03 0 1
 " " 1 "" 03 (\$%&4 /\$%& 03)
 5 03 3 "
 6 # \$%& 7 03 1
 1 8 ,,# 1 (1 1 3 03 1)
 9 "1 8-,#

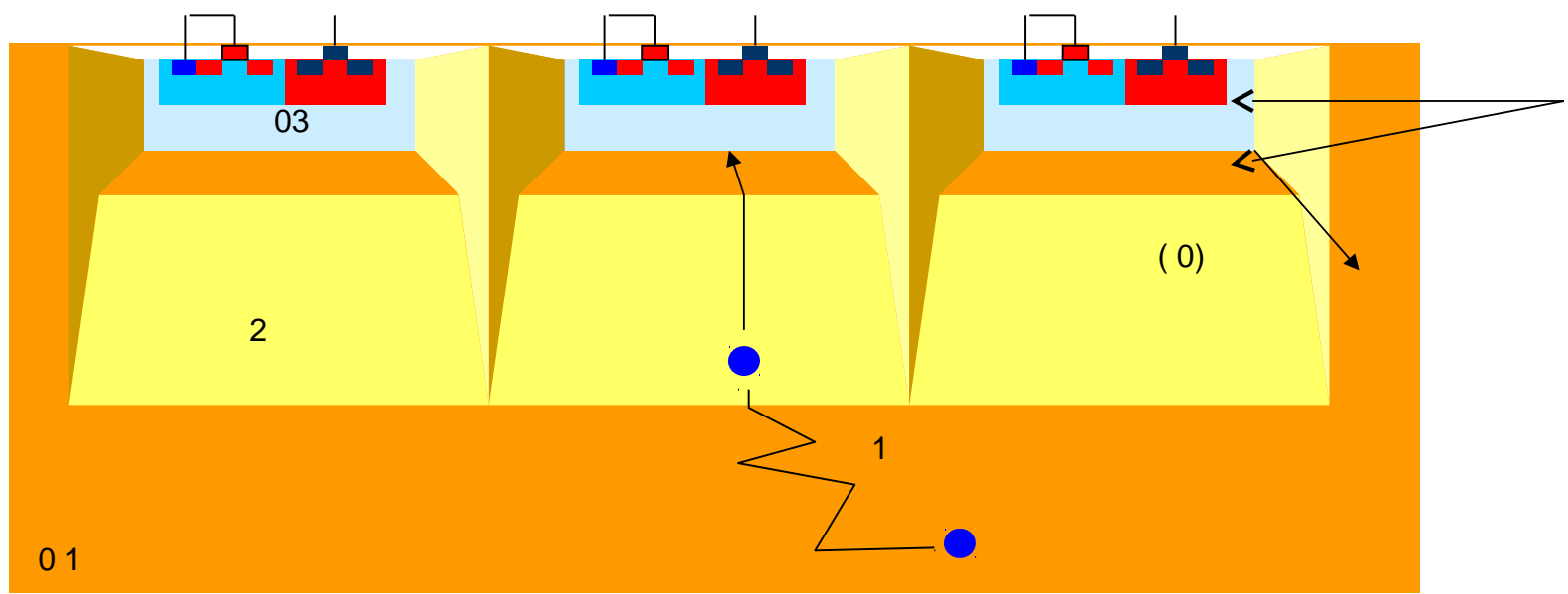



;' " 9\$&4 ,< , Ω " (*+,<- , " \$%&) 1 0= 8
 ,+ "0*
 " " () .,#
 (8 ,, " ')4 ,>" (*+ , ") ?>" (- , ")
 5 " 1 \$ + ,>" ' + ,>" ' 9\$& ,@*+>" (.,#)4 -,,
 " (,>") 1 -,, " 1 ,,,
 (1 3)

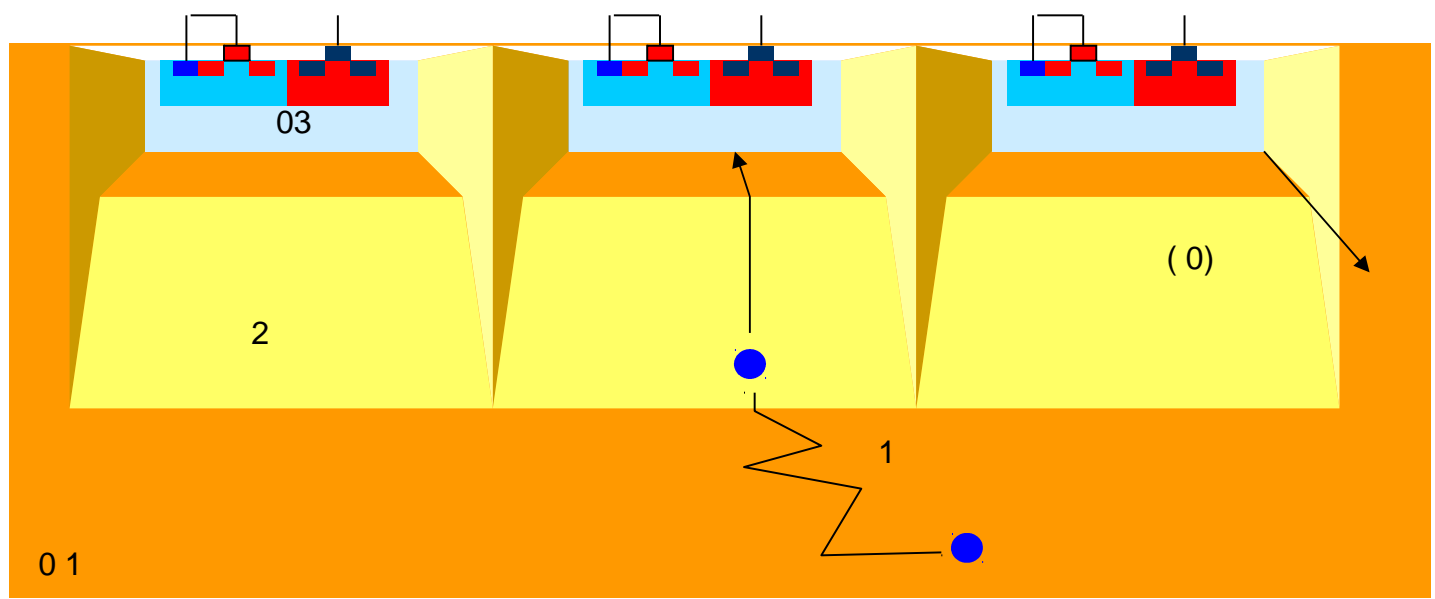



5 " 1 *+, " 4; " 8-,, " (>"' >" ')
 1 8 ,,

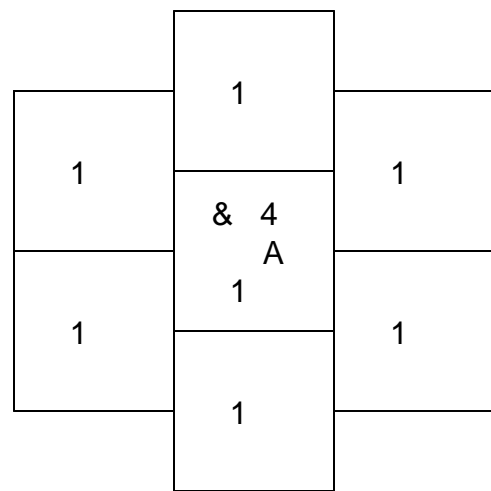
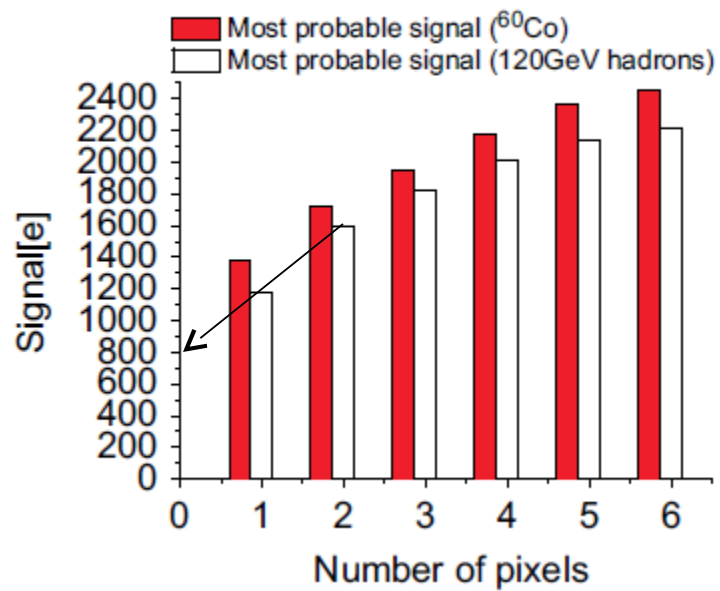



1 3 -,"7**>"' +>" '

\$ 1 & 0B,\$ +,# 8.,,

C 1 D " 8 -, ?-,

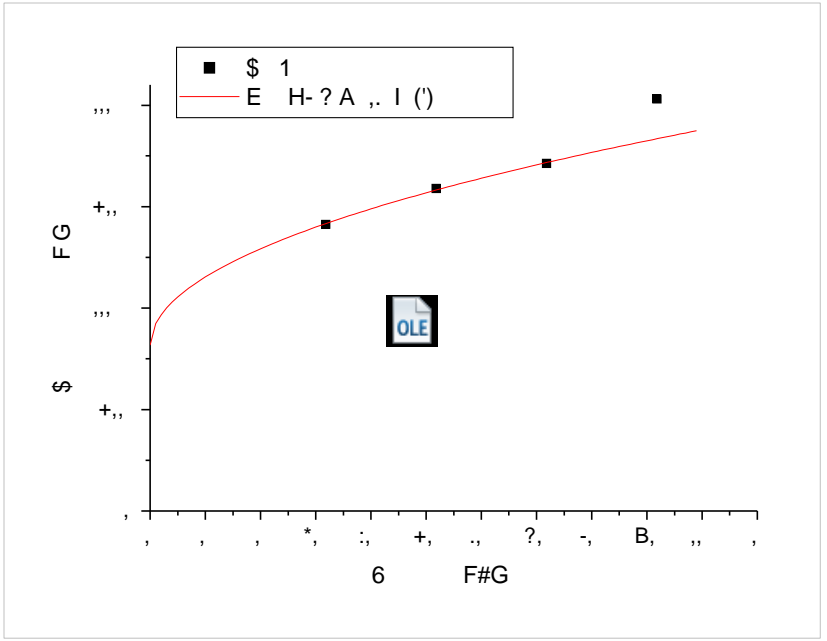
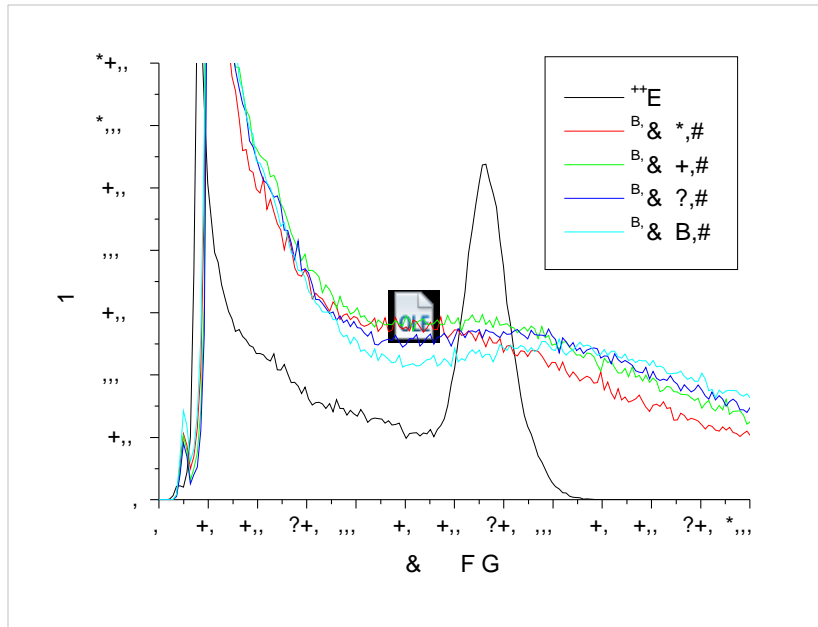



J " 1 (1 ") 1 (1 ") @
 J 5 1 " 1 3 1 2 " 1 K @
 J 5 " 1 " 1 55@

55 " 1 @ @

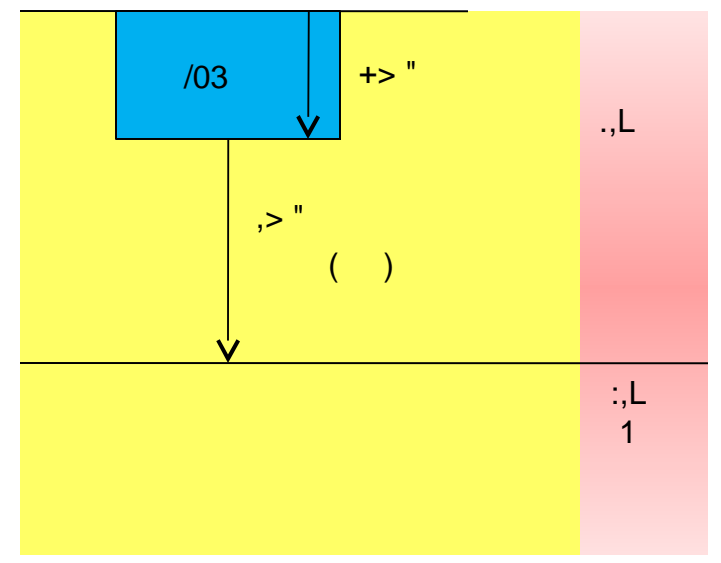
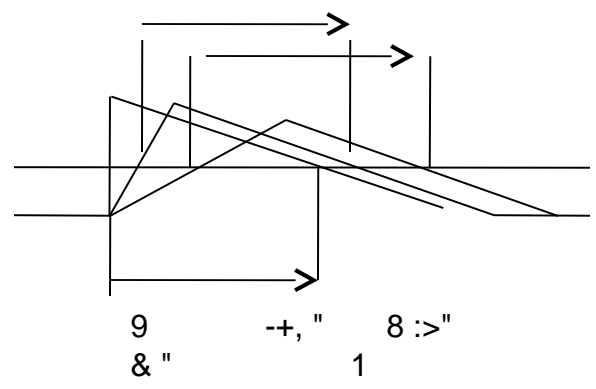
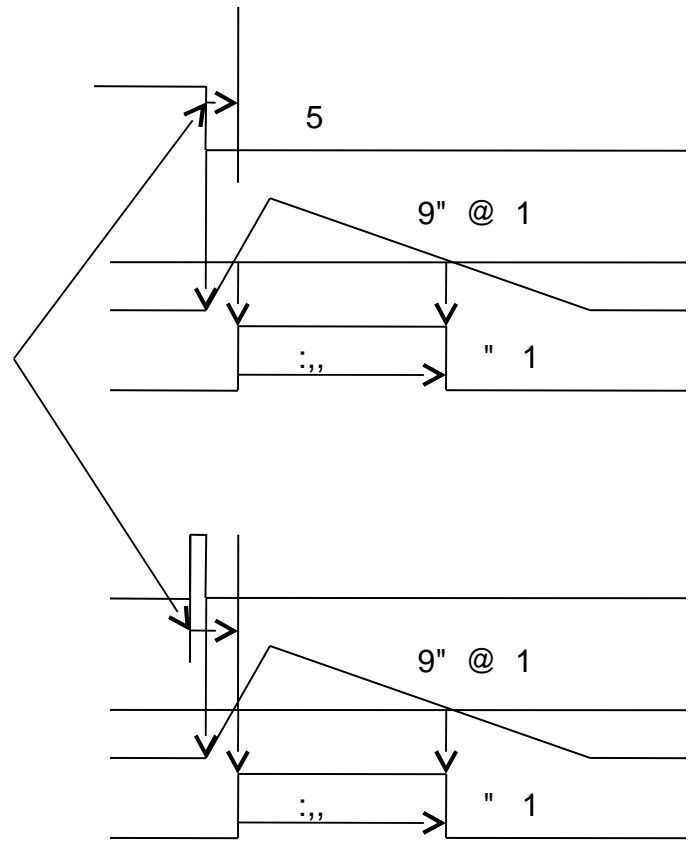

7 " 3 K @
 / " 1 1 1 @

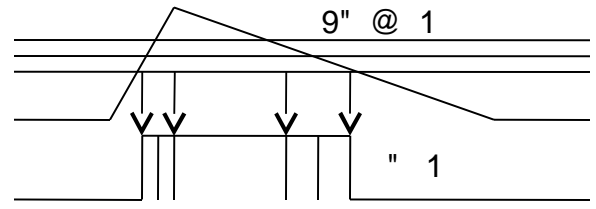
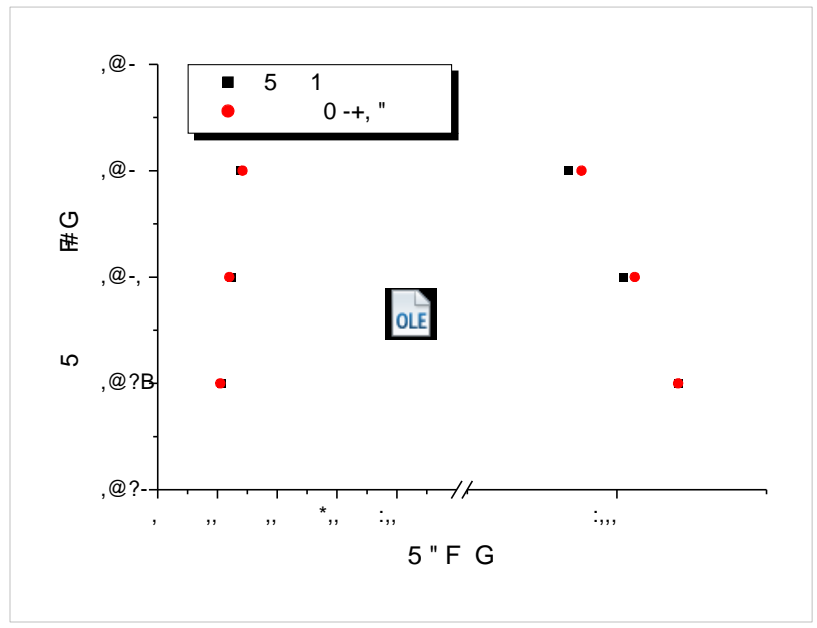
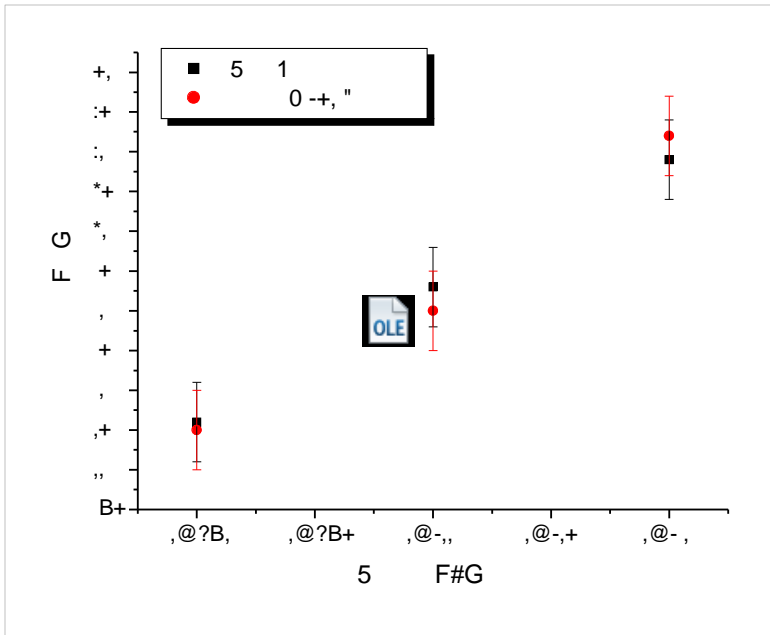



53 " 4) ")
) 3 1 (") 9\$& ,@*+>"
 &
 5 4
 9) \$ 3 \$%& '
 ' " ' 7 \$%& " 1 1 "
 1 M
 6) \$ 3 :0 \$%&0 ' 1 %
) 1
 ! 1 =B-L 0 "

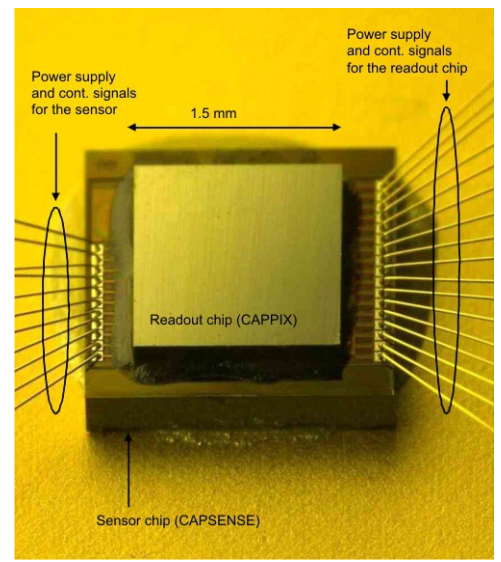
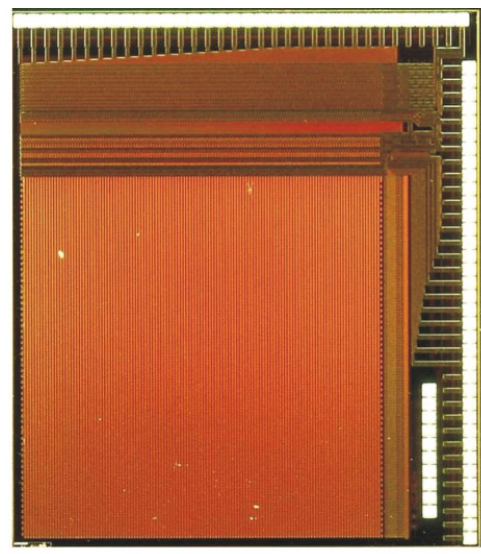
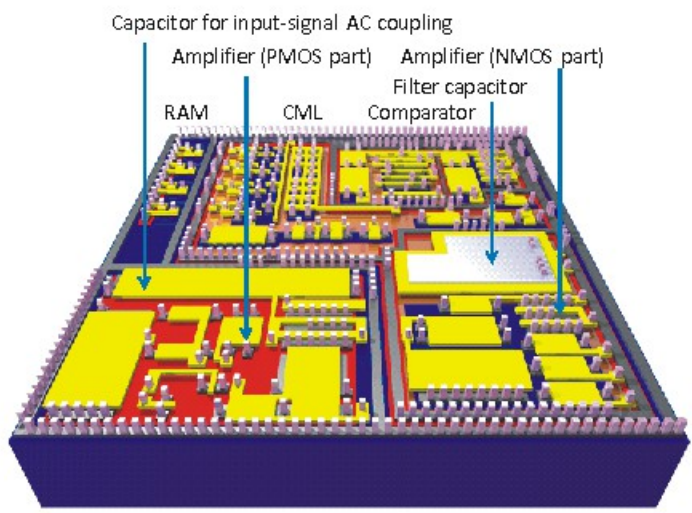

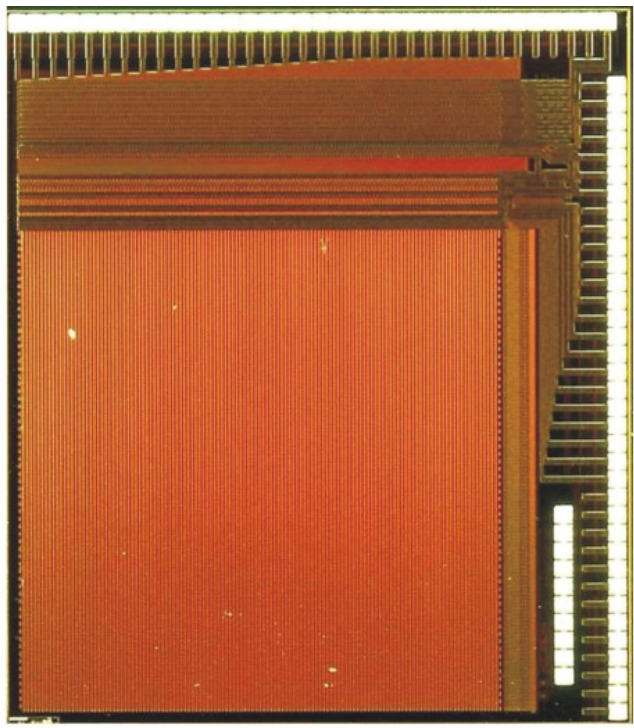

' \$ 4
 ' > " ' 2
 - - - - - " '

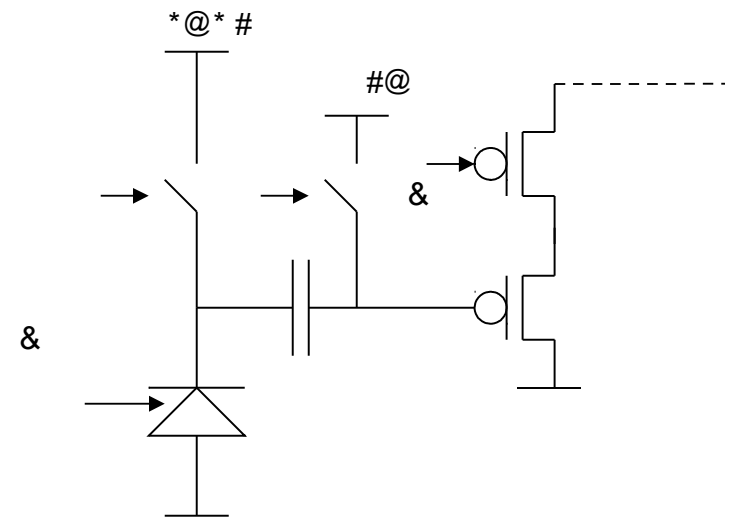

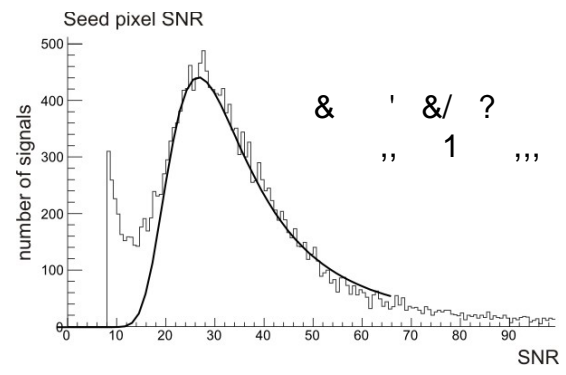
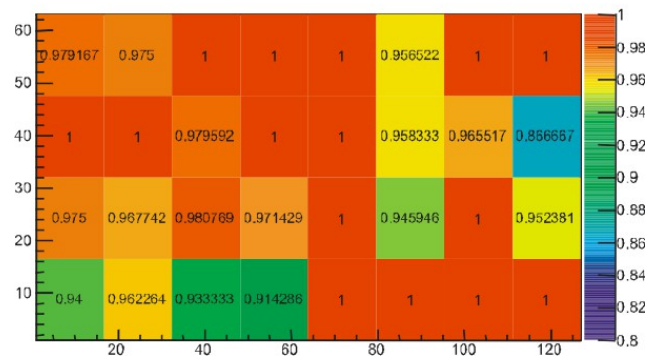

; 564 8B-L (1
 1 7 3
 1 .: @

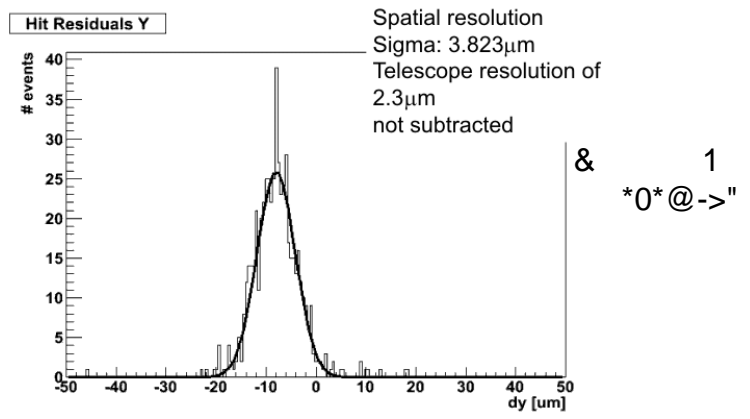

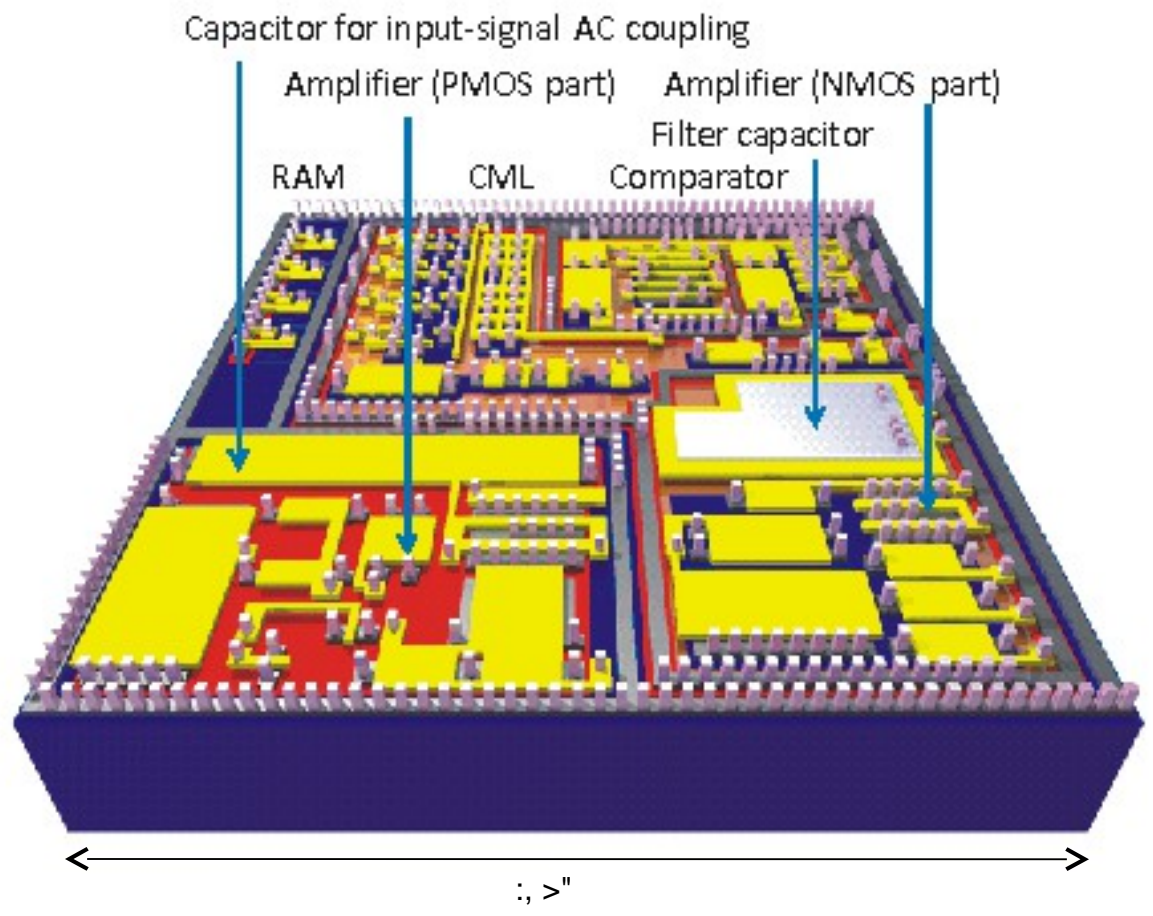



N 4 ' " ' .., 1 1 @
4 \$ 1 " " 1 & & (; /) @

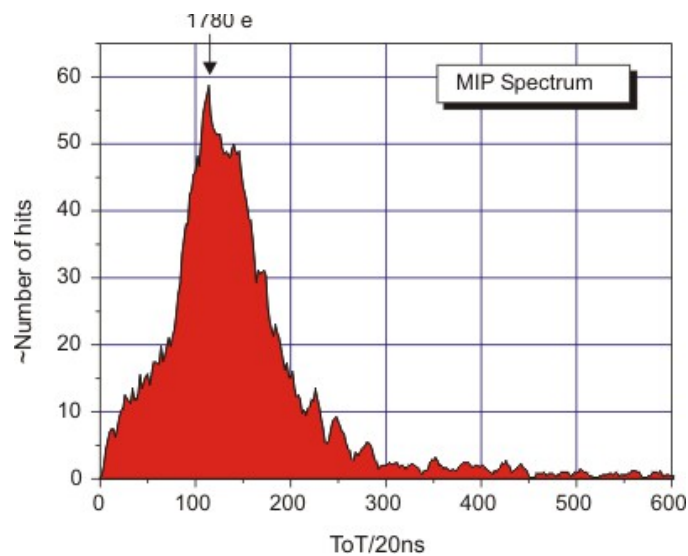
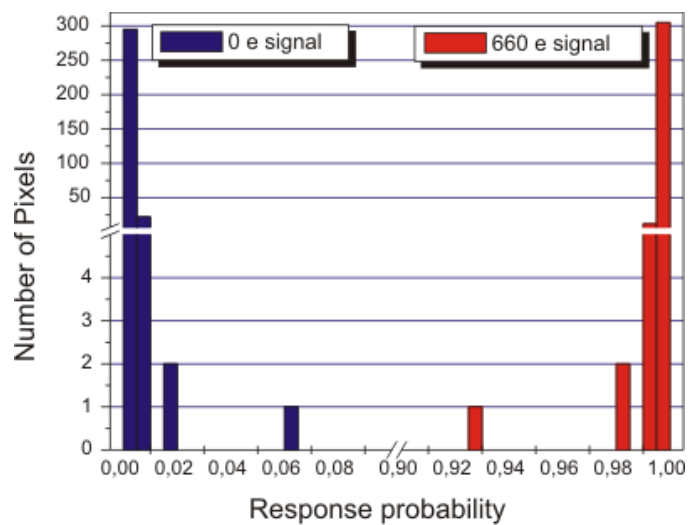

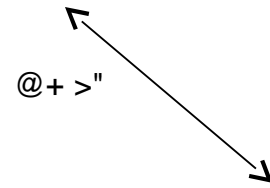
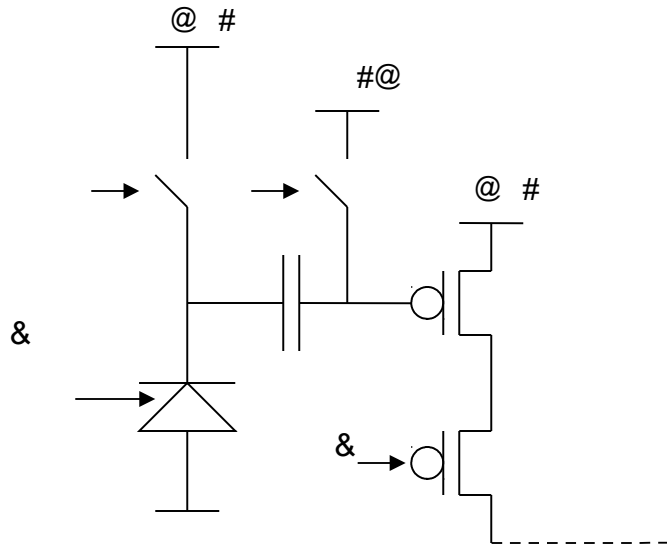



++E " 1 "
& 3 . μ" 3

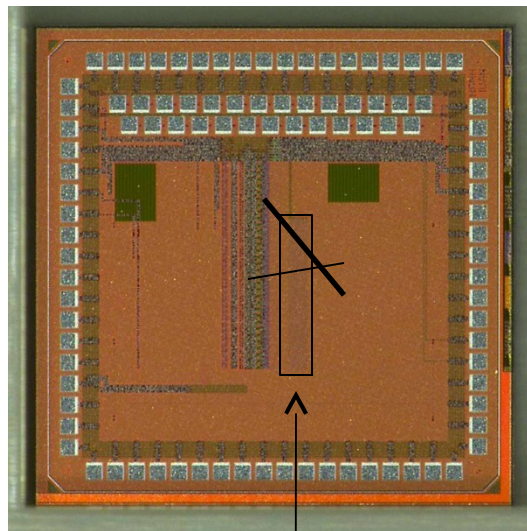

' " ' (*' +.)

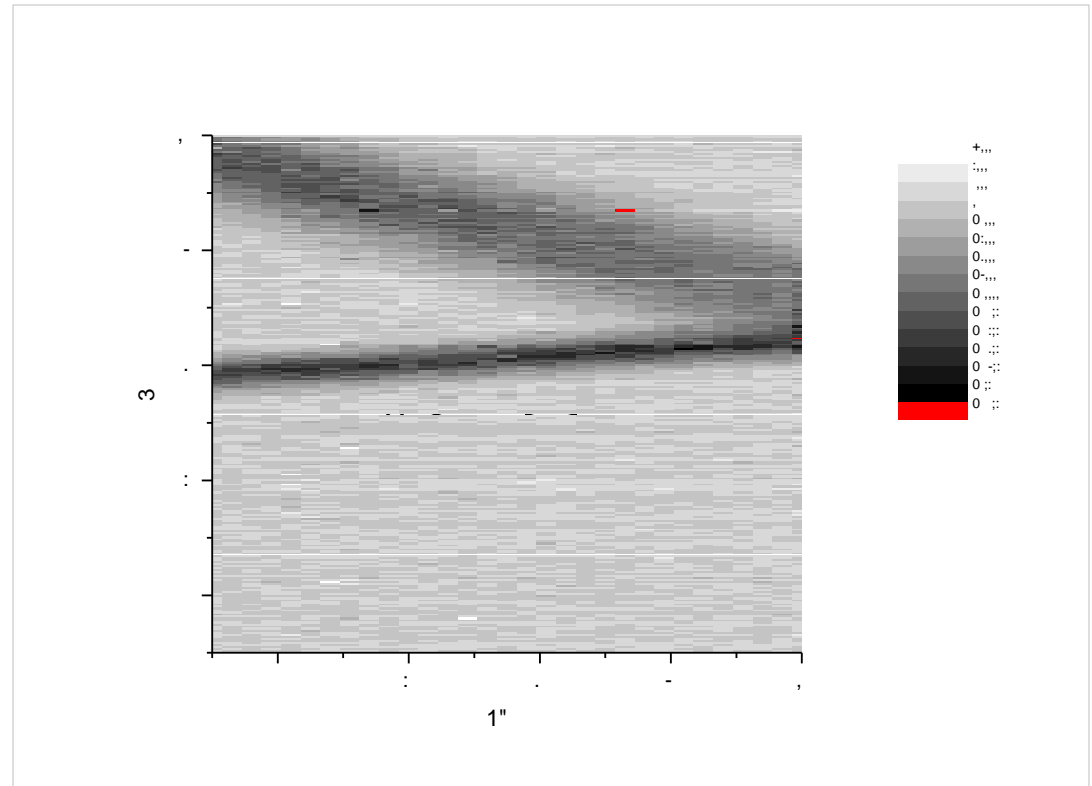

! 4
E (8 .0-@+##<>" " 8 ,,)
5 (,>" 1)
1 1 "" (@+ ; <- 3)
4
&" " (" , 1) " 0()
' 8,, E ' ,
&/ " 1 " 3
\$ 4 3 " 3 3 1
&"1 "' *,>"' +>" ' 4 &/ " 3 1 ,
3 1" 1 ,, "<"
&" " "
9
& 1 4 1 " ' "



\$1* 9/9 (!&)
NN @ @ 95N9&
N



-, " # \$%& 1 3 3 1"
 N 3 l1 H= " '+,>"
 ' &9 1
 1 3
 5 ' (-,>" ' -,>")
 9 4 " " ' " &/ 1
 4 (1 +L)

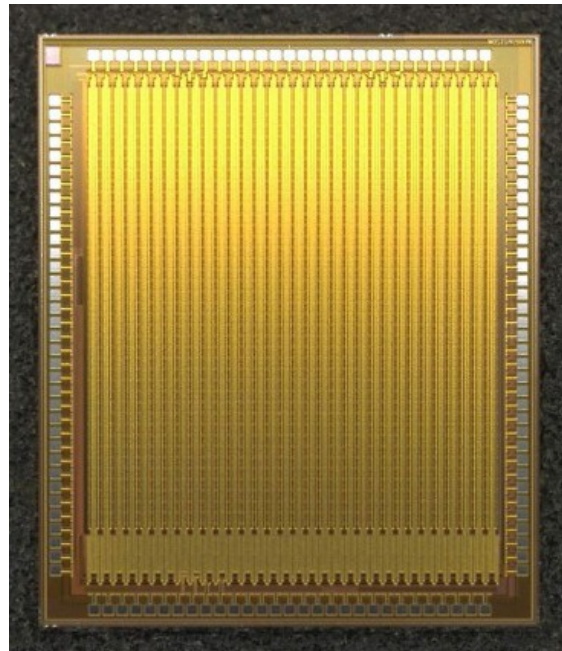
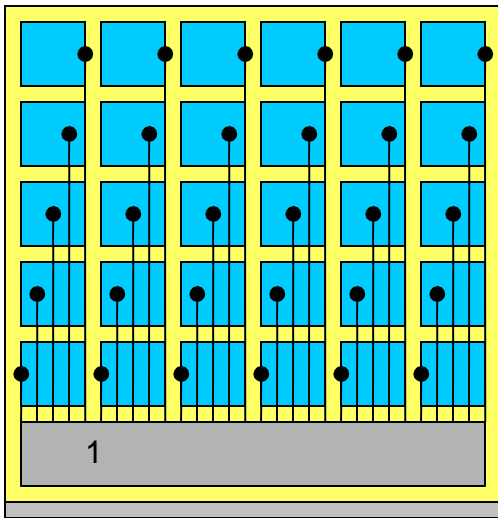

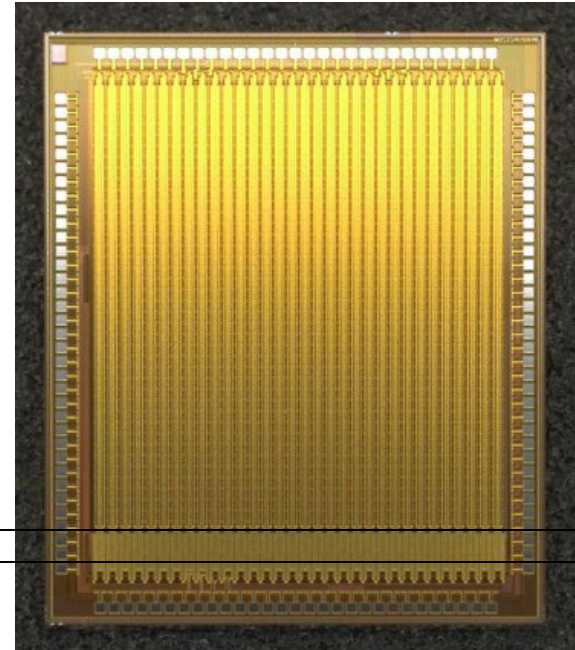
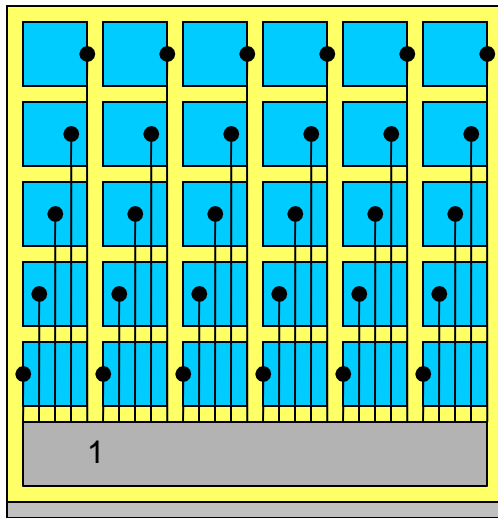

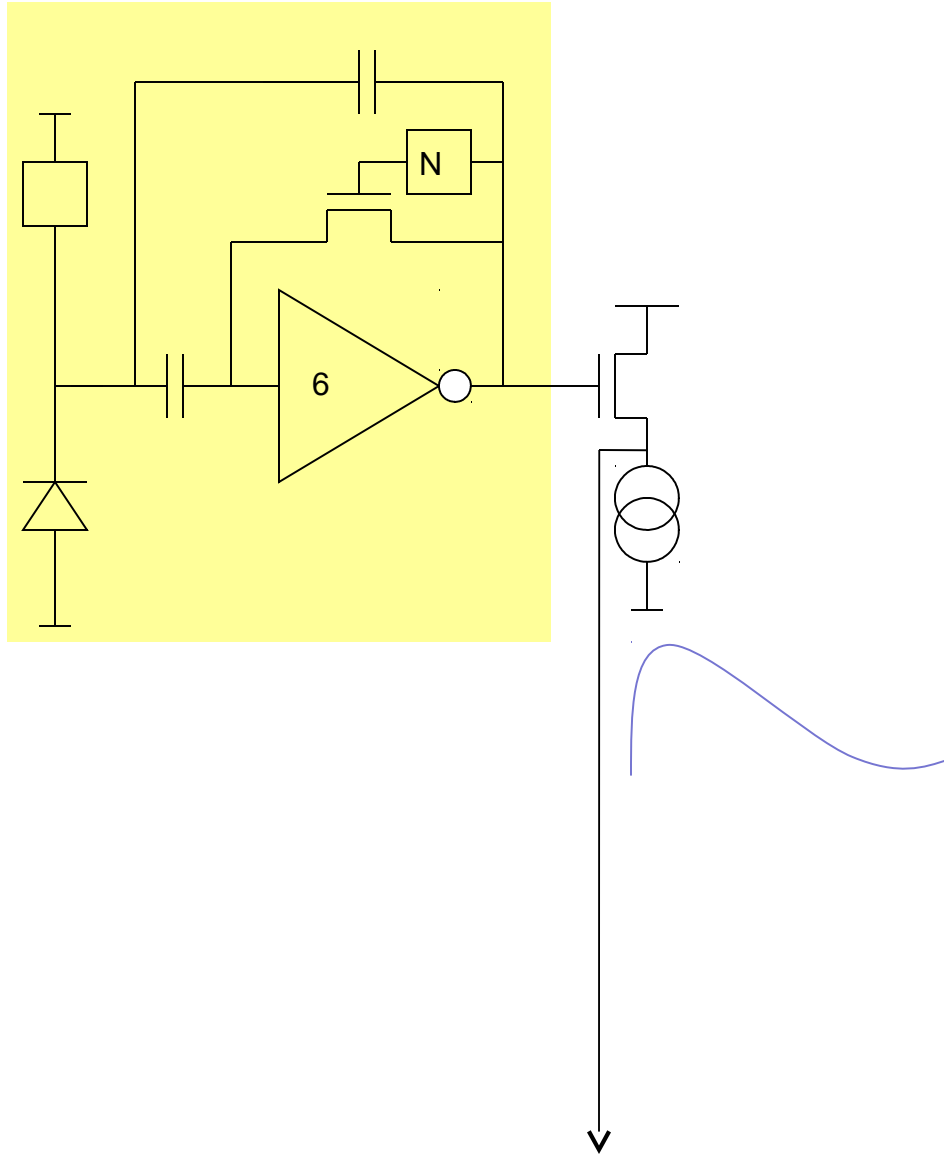

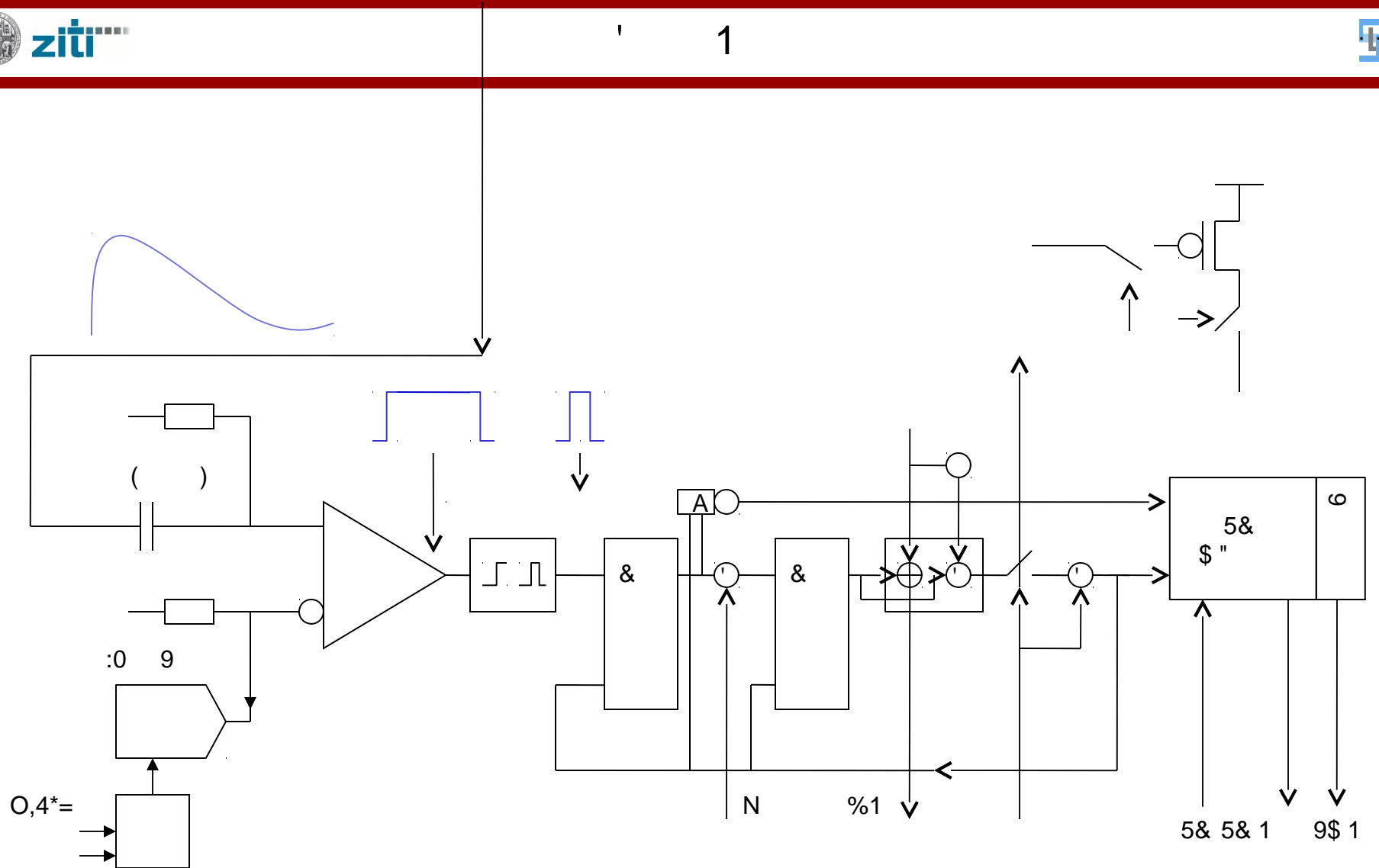

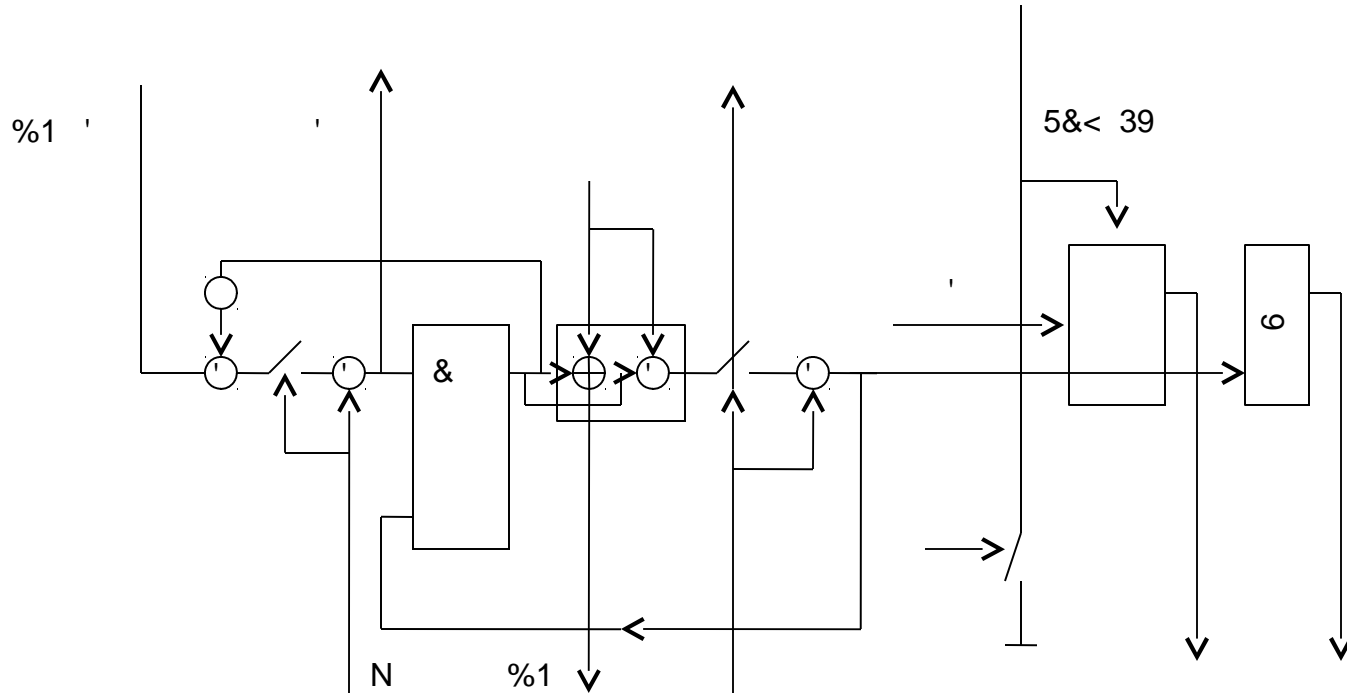

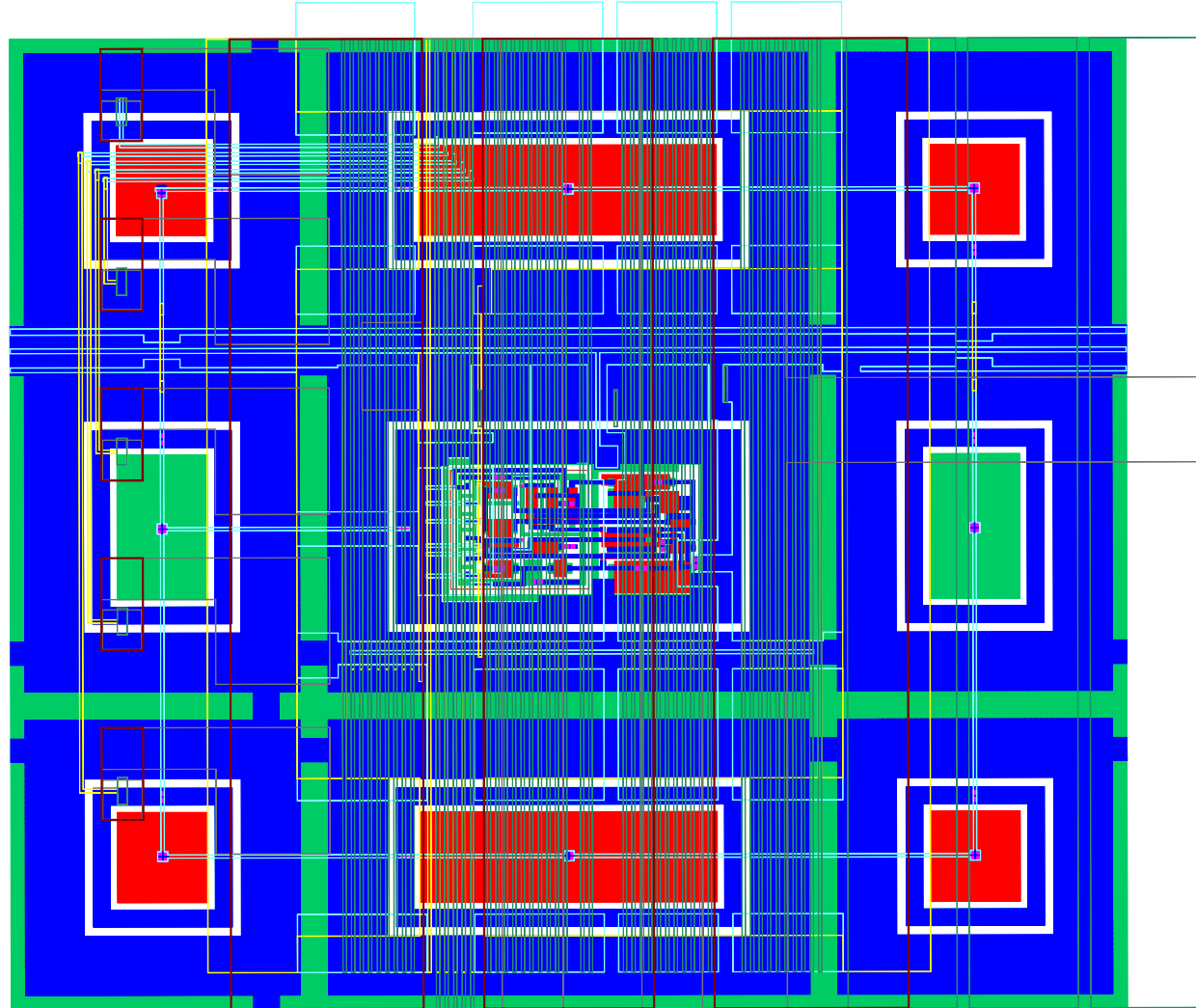
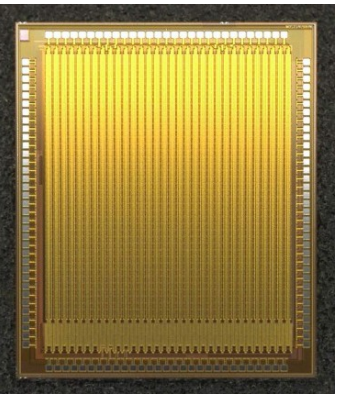

← B >"

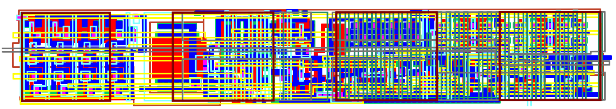

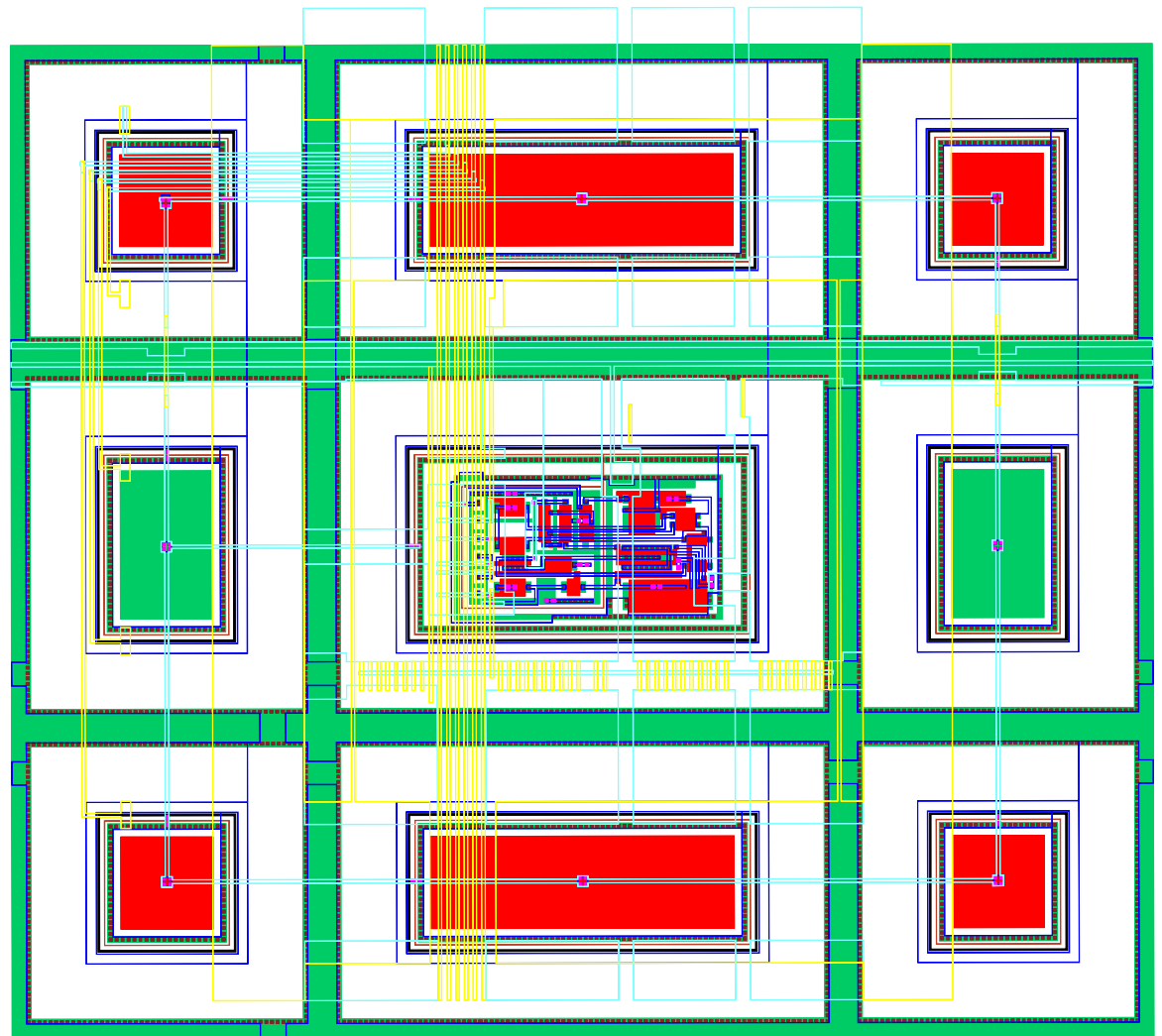
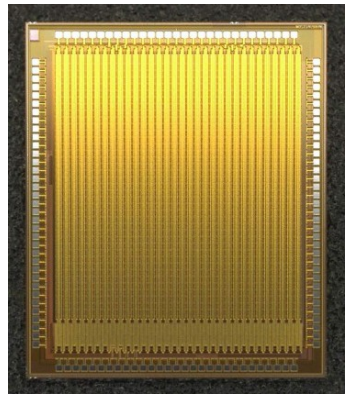

← B >" →

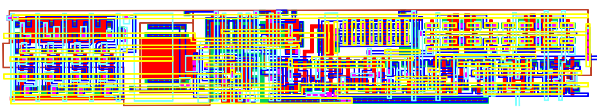

:

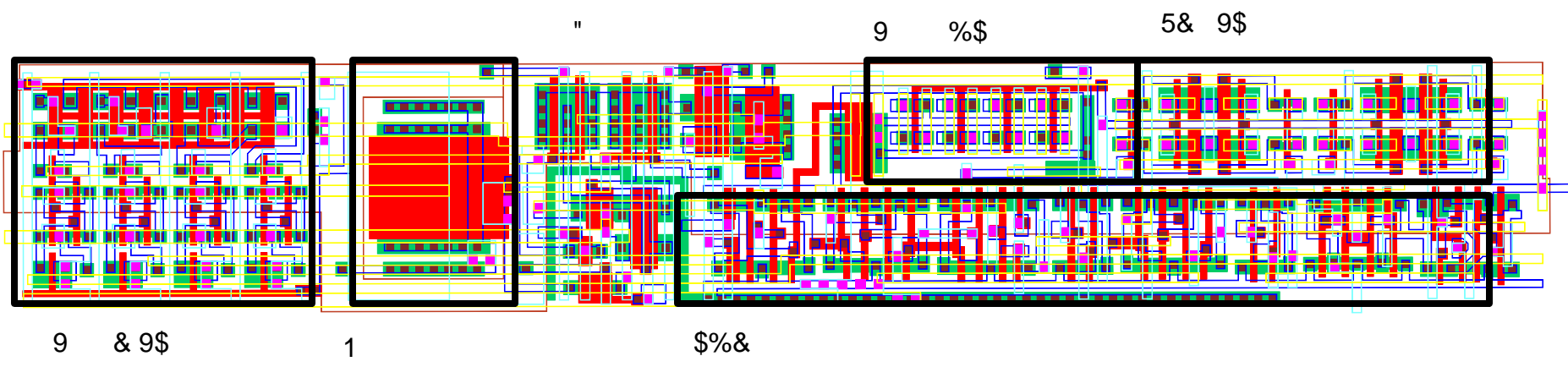

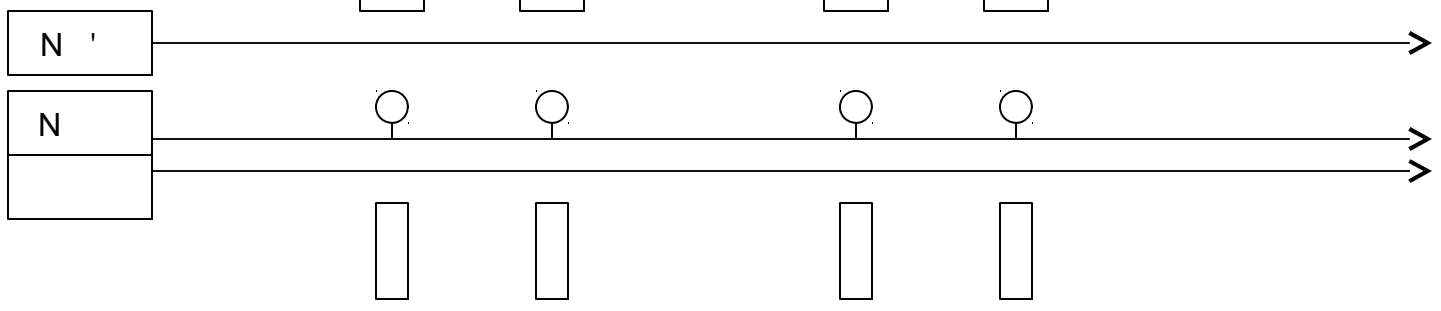
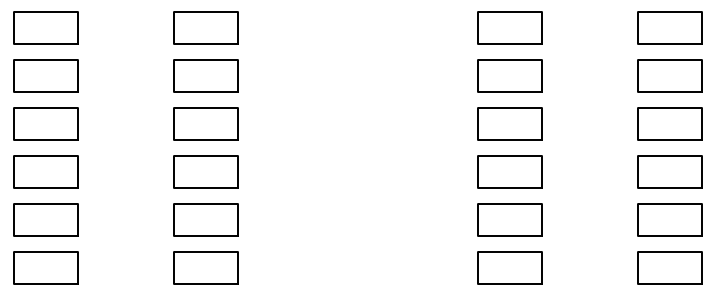
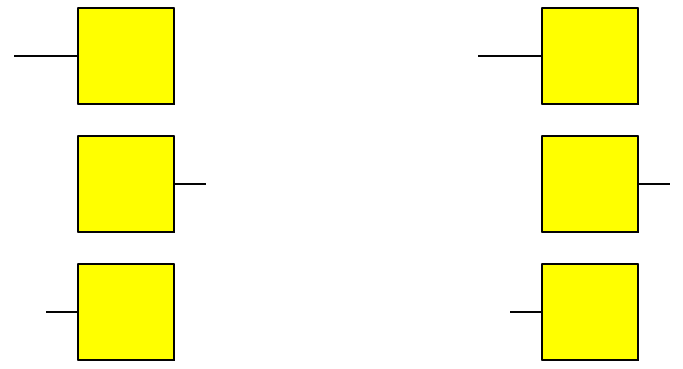

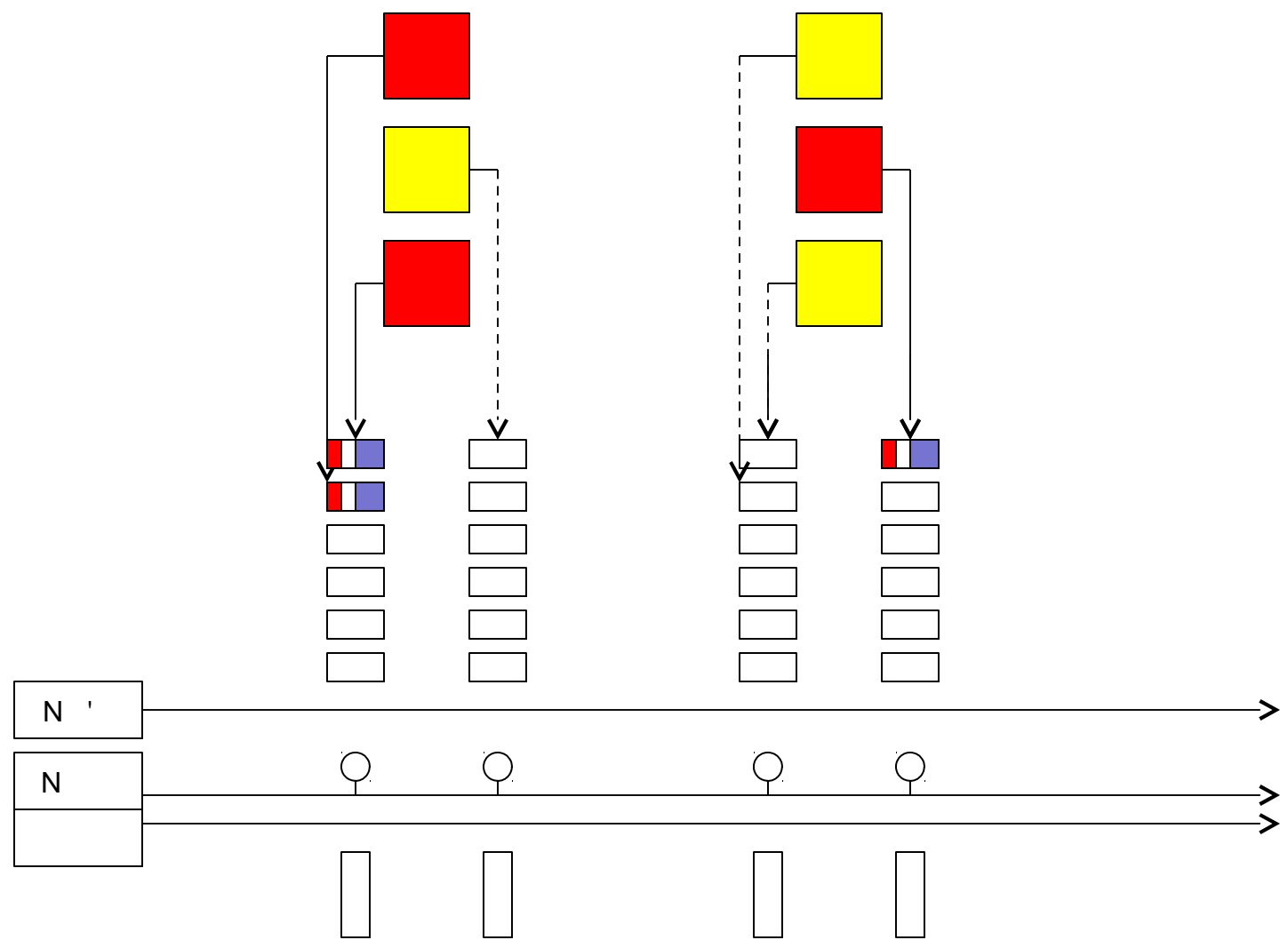

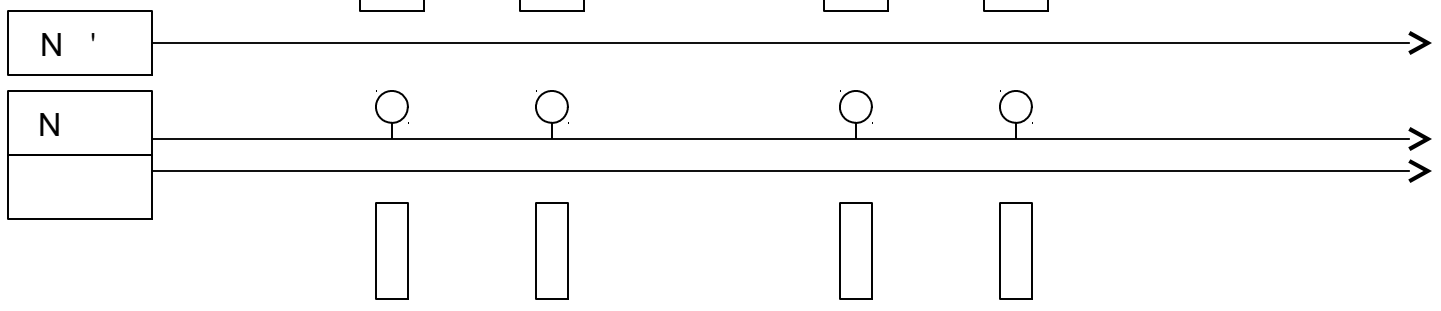
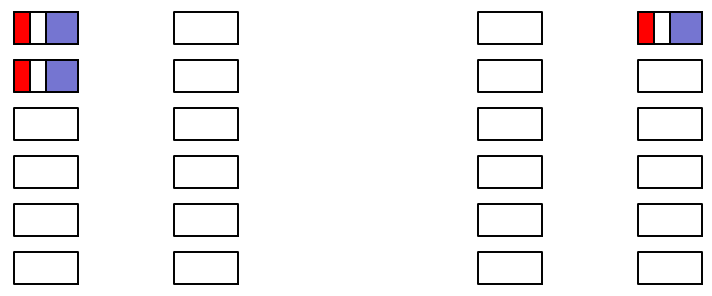
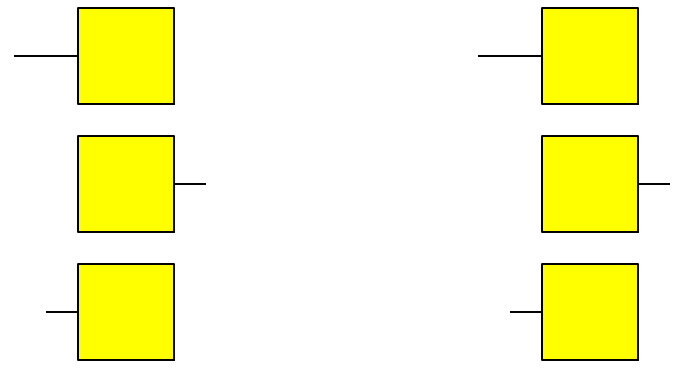

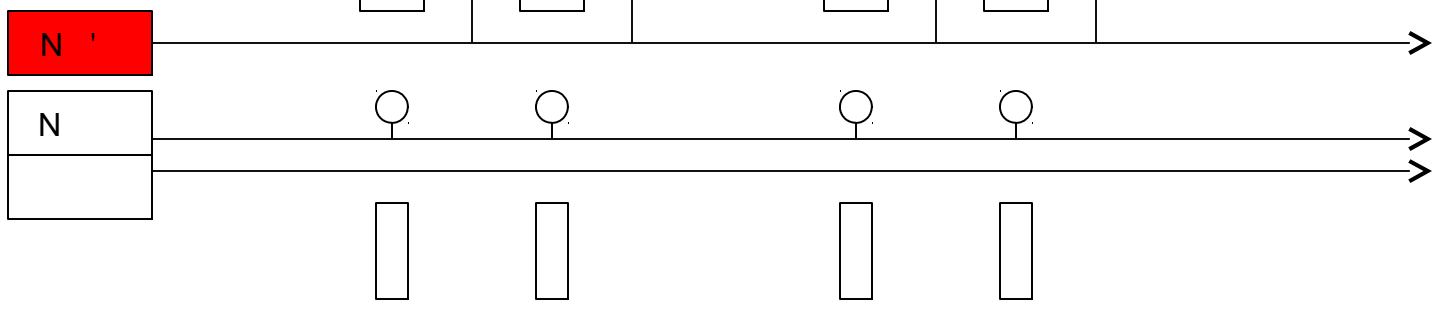
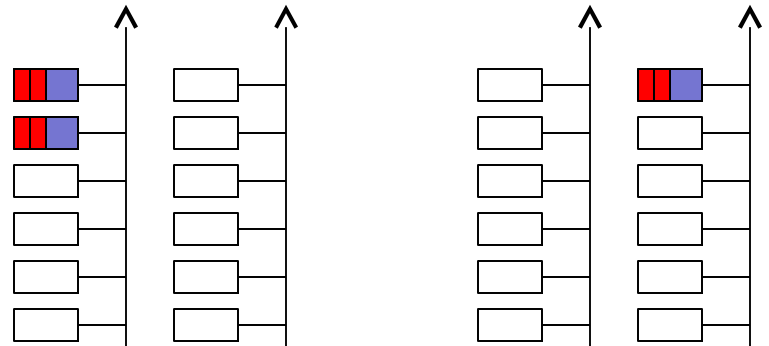
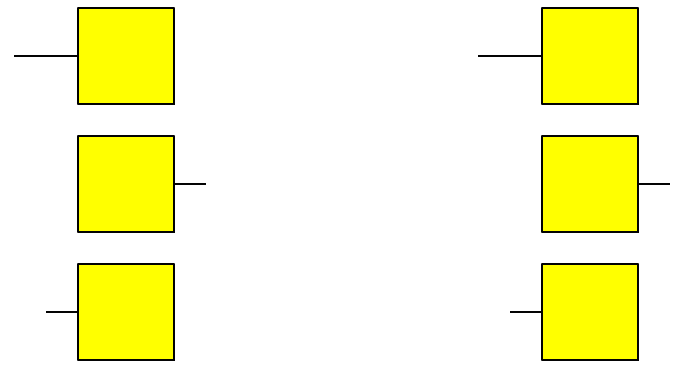

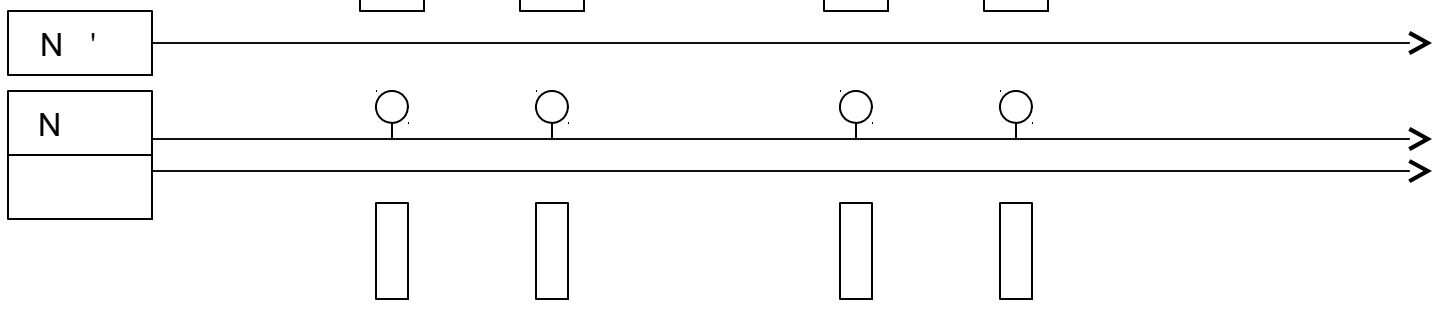
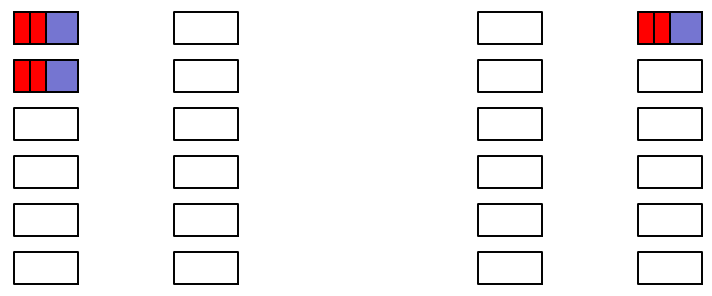
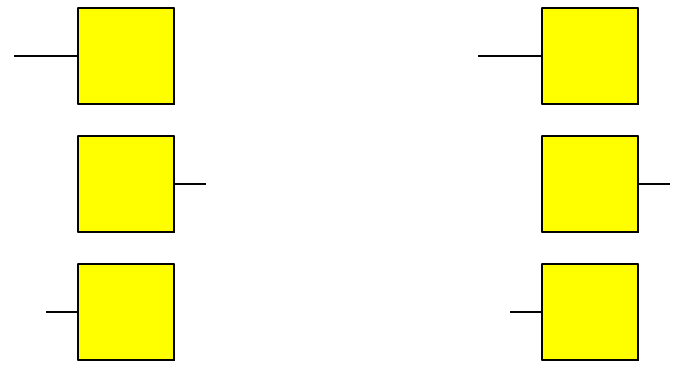

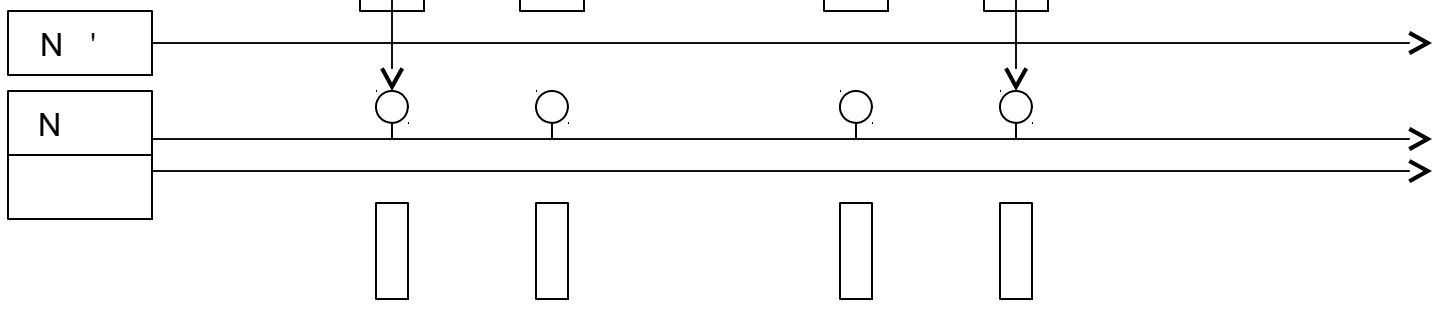
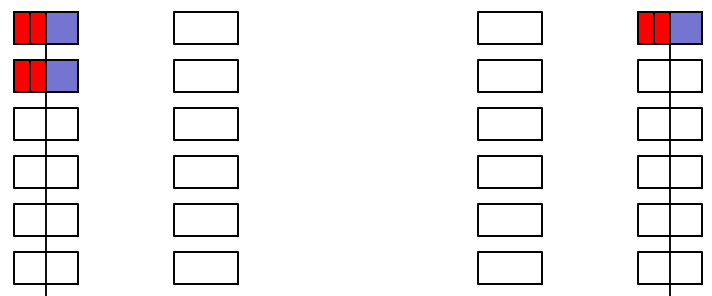
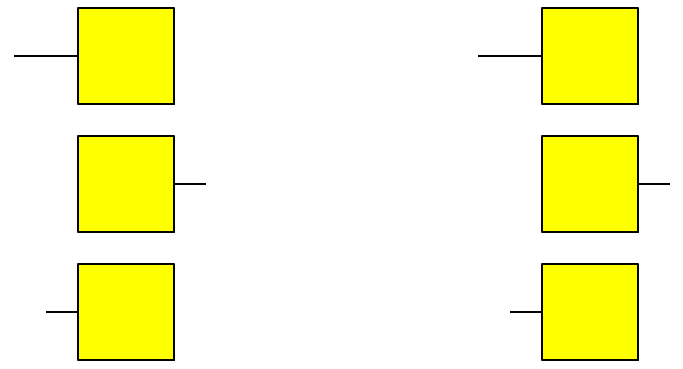

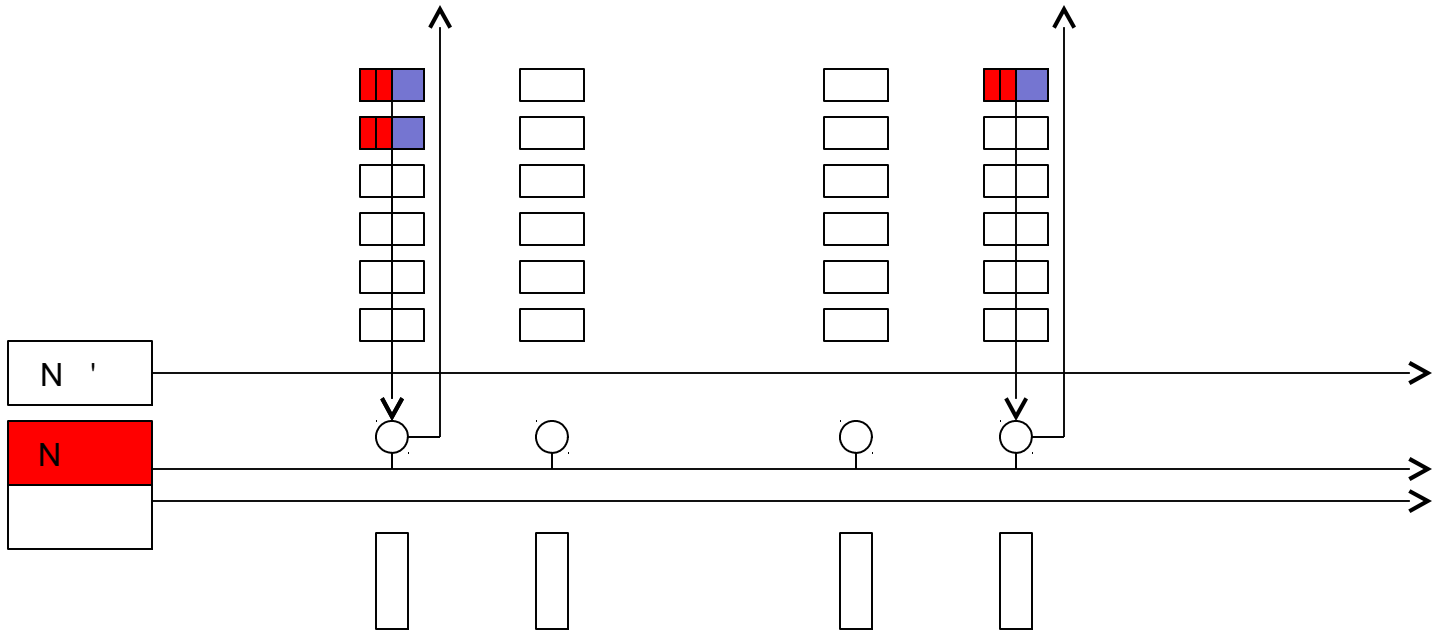
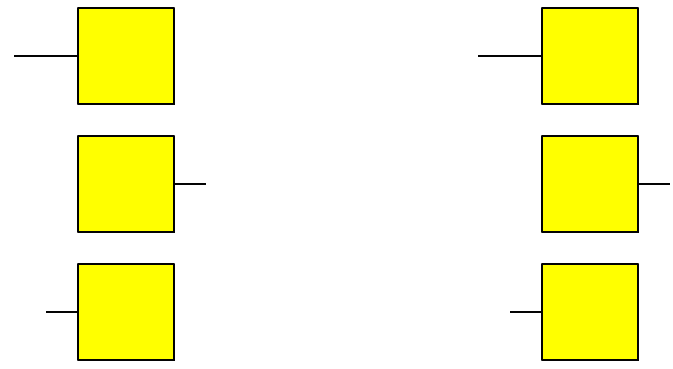

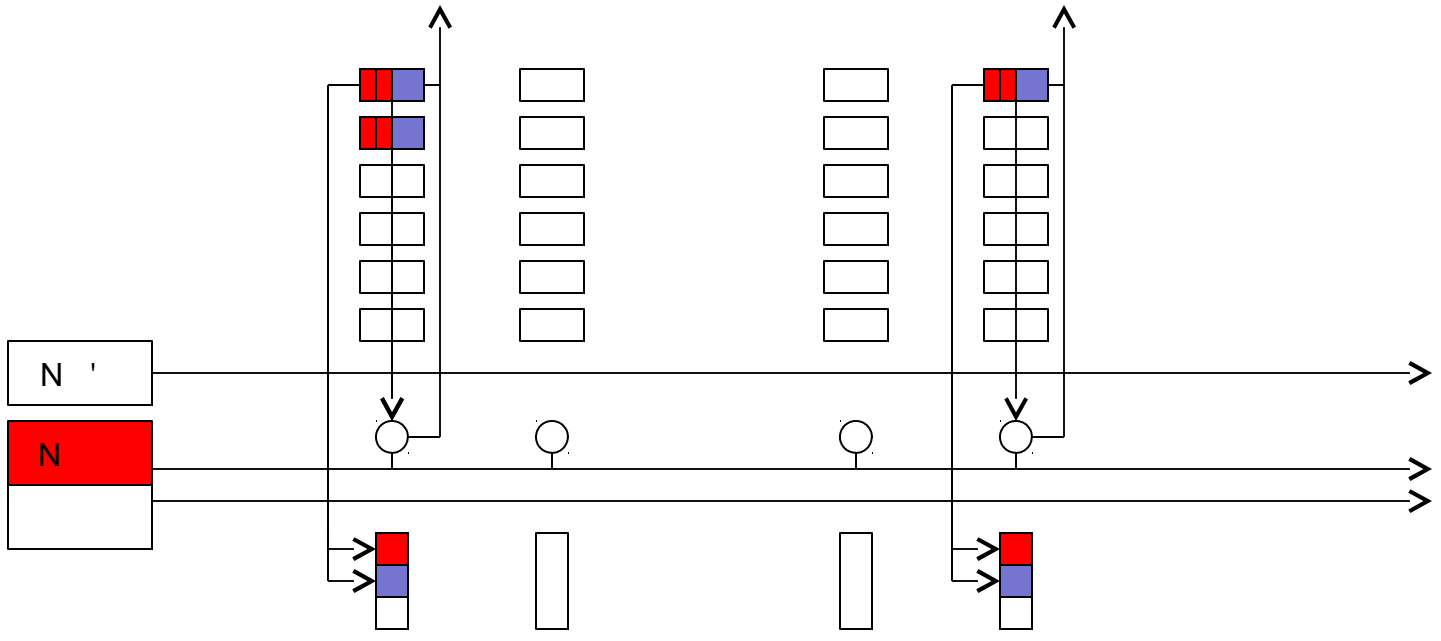
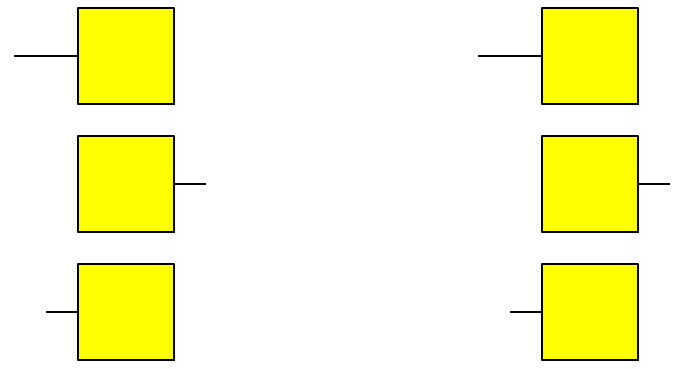

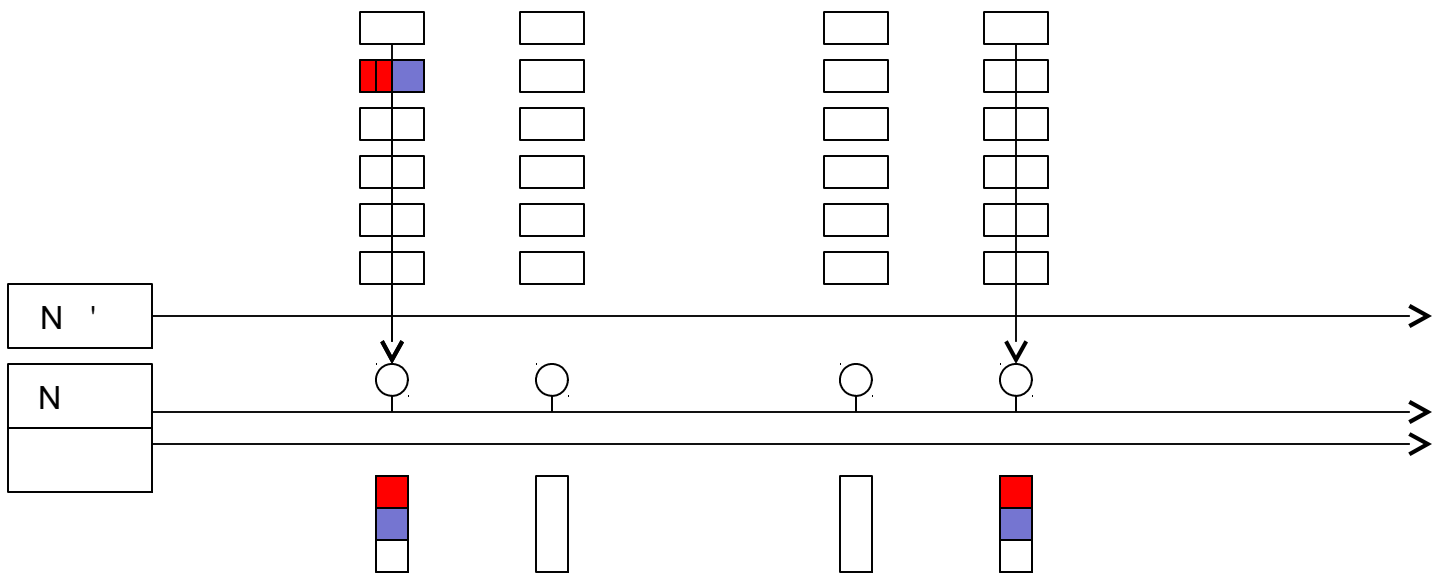
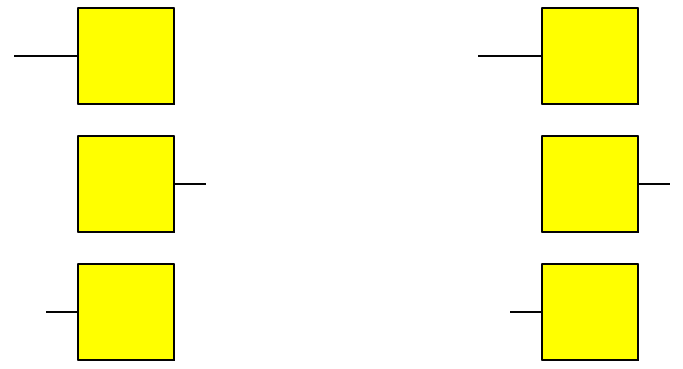

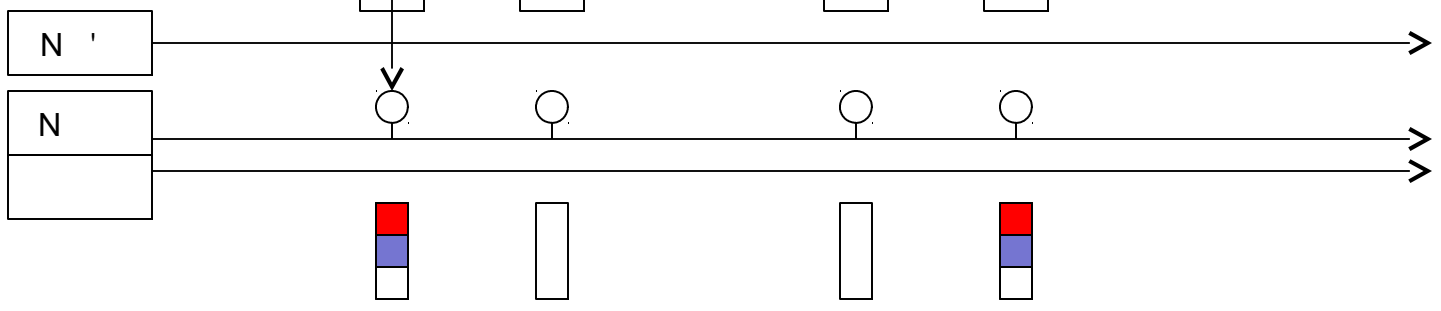
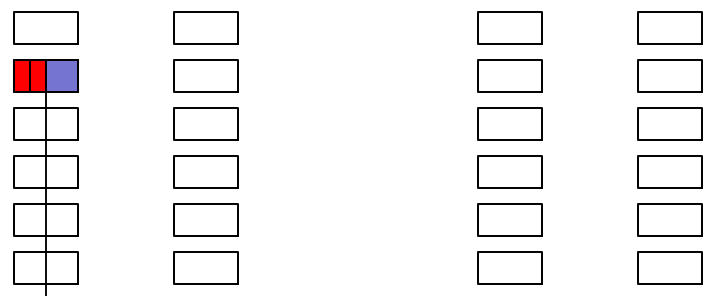
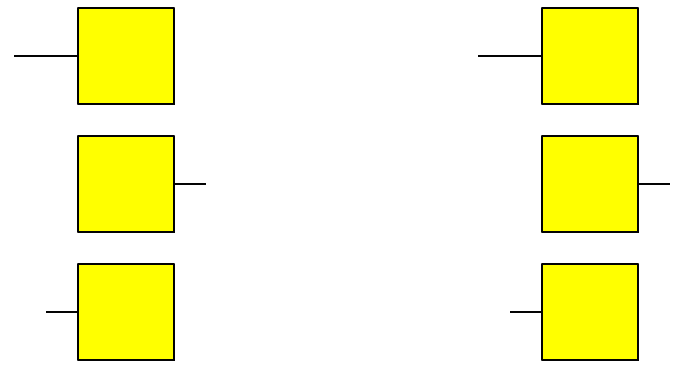

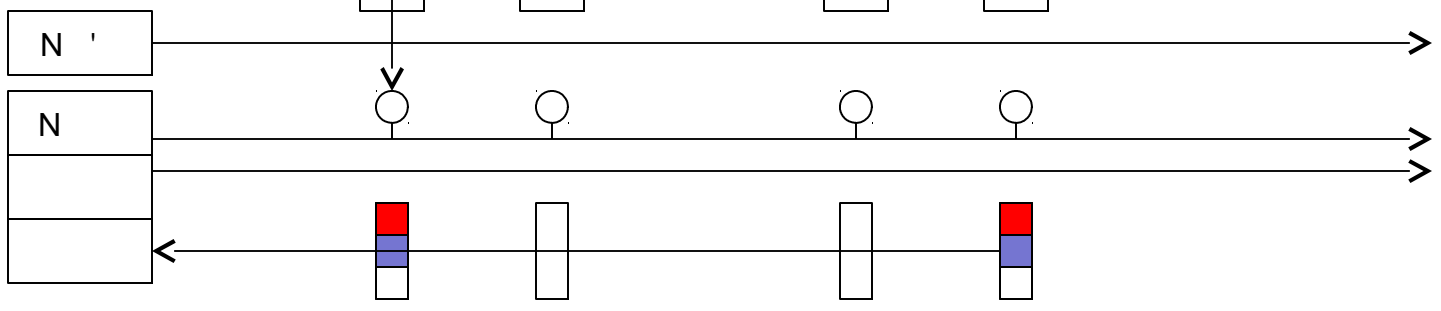
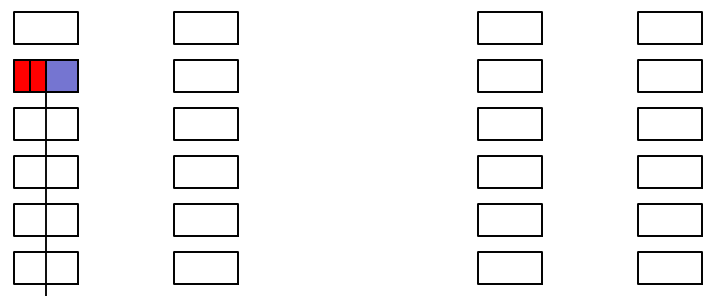
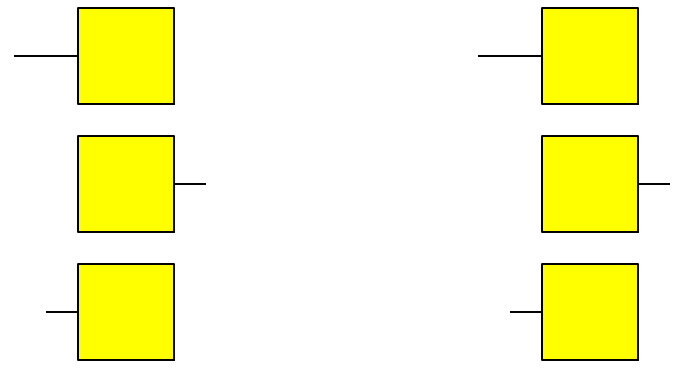

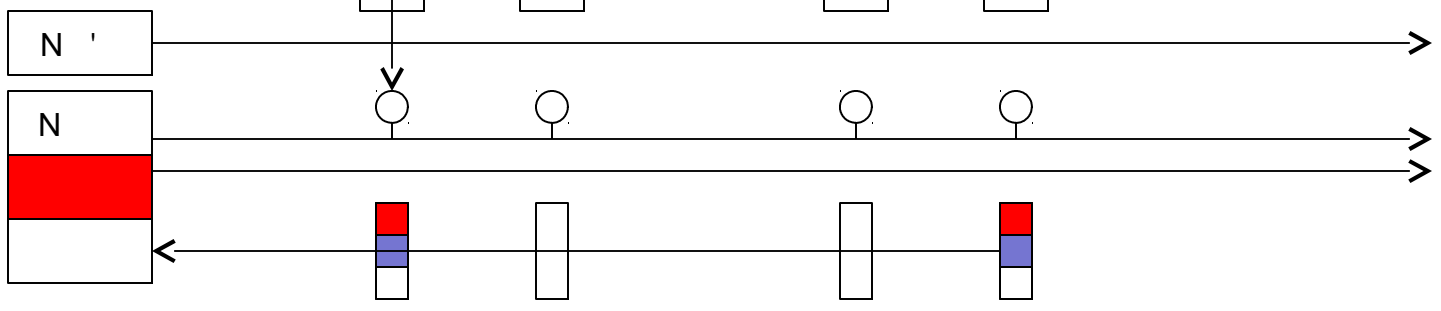
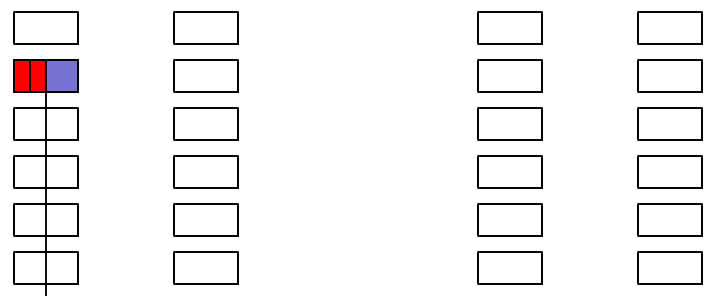
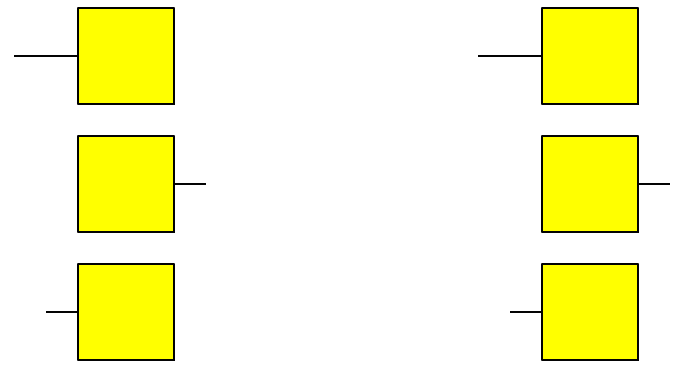

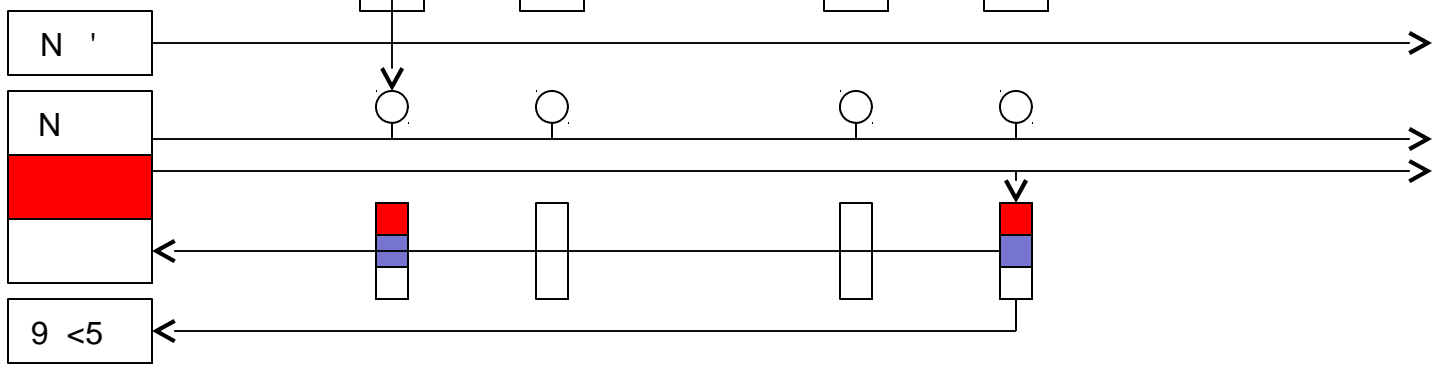
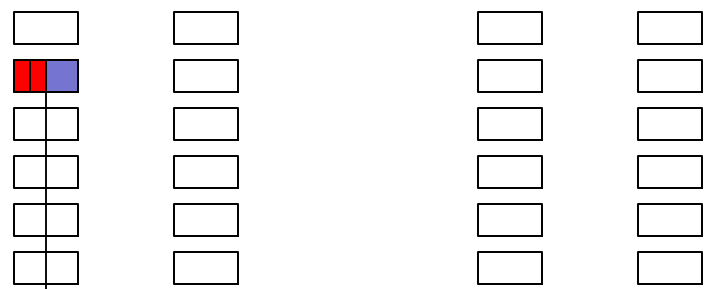
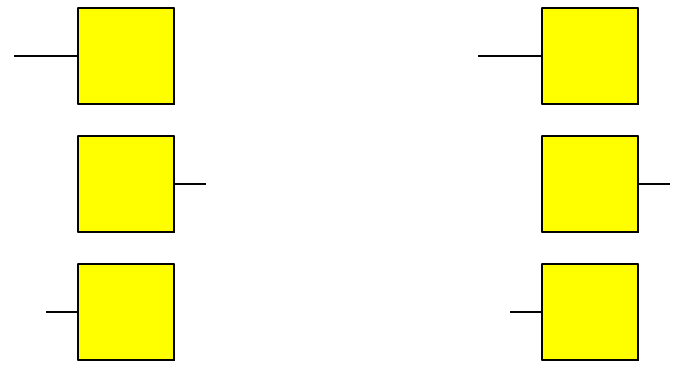

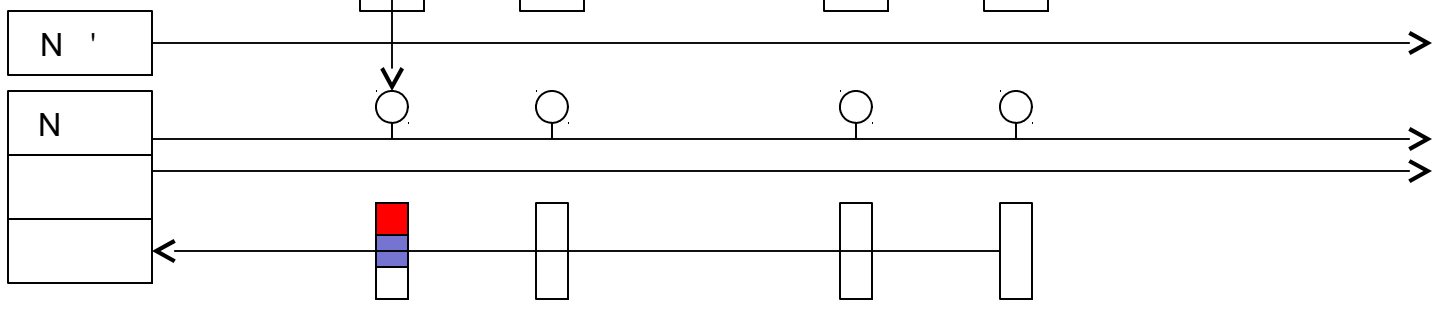
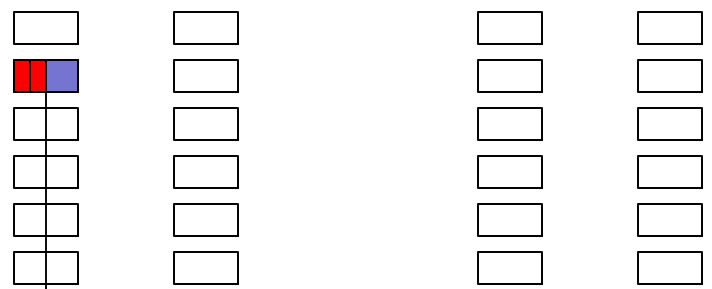
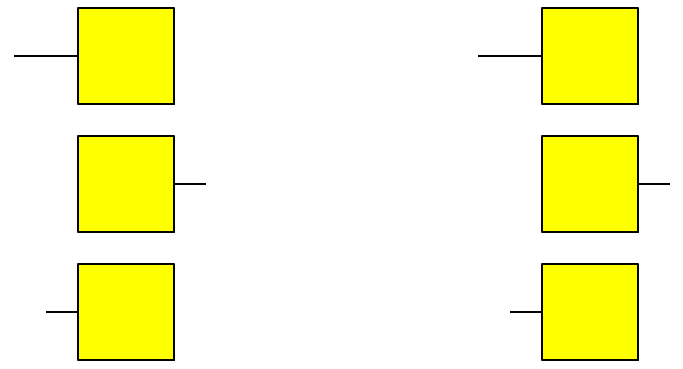

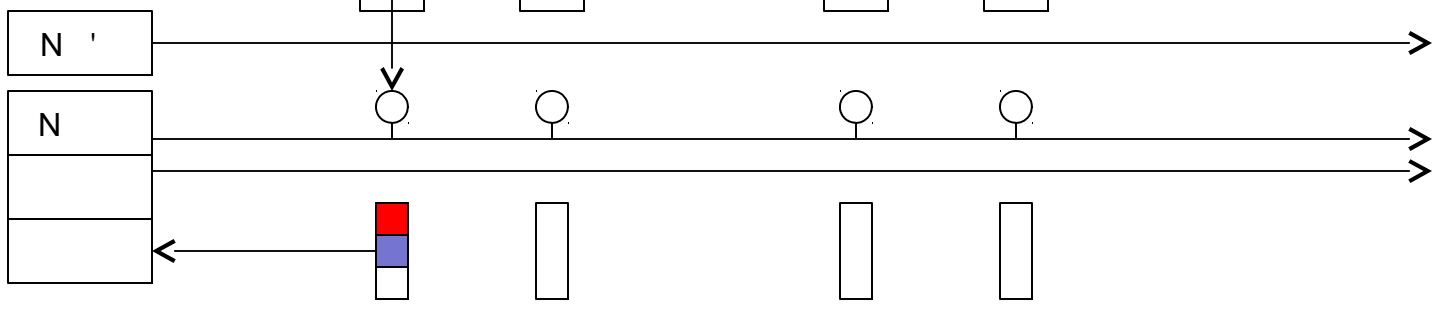
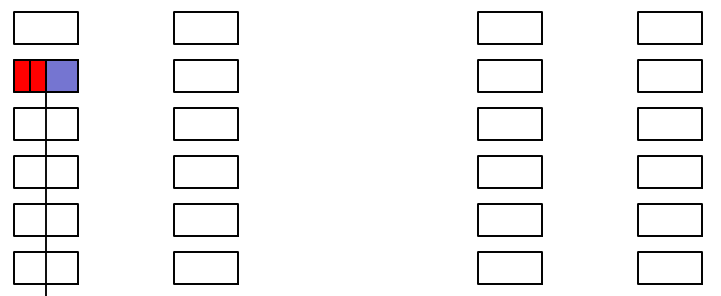
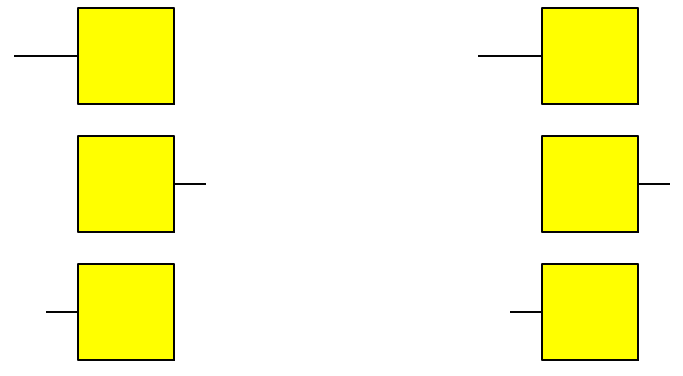

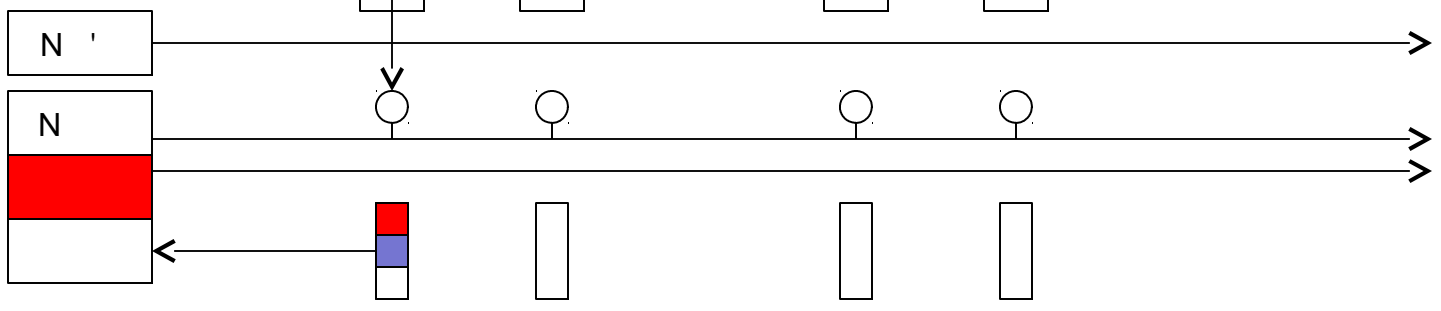
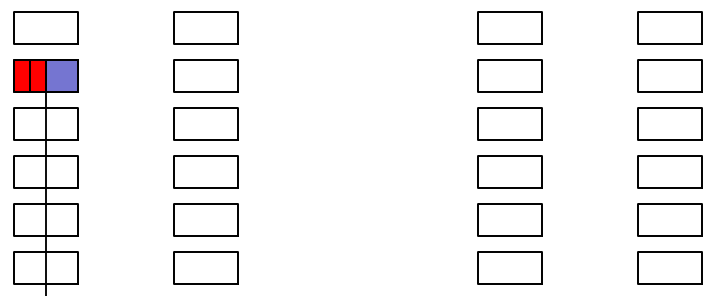
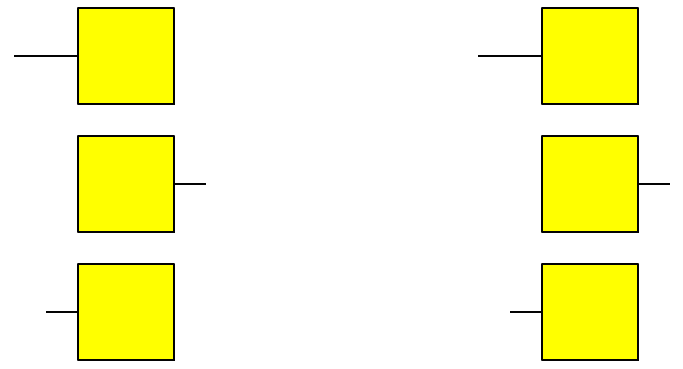

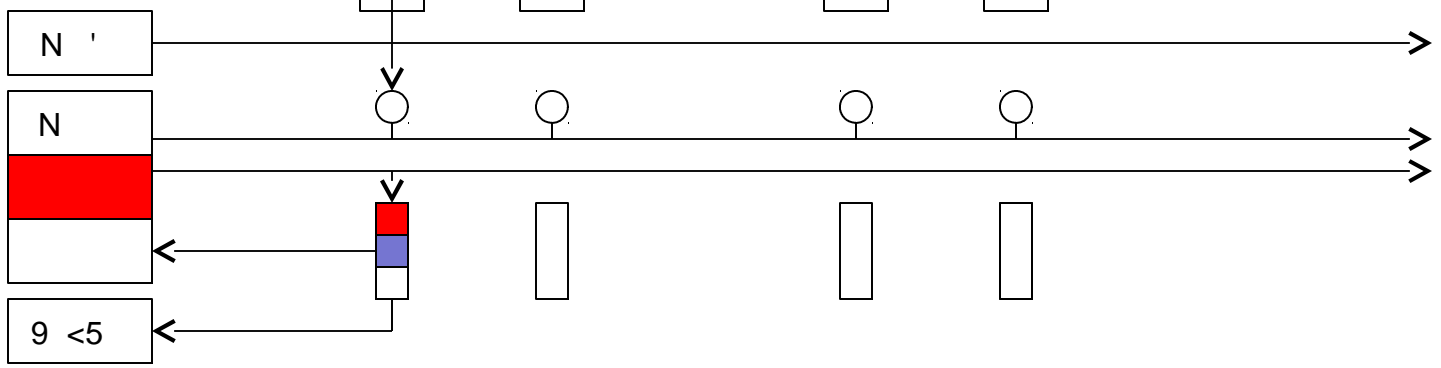
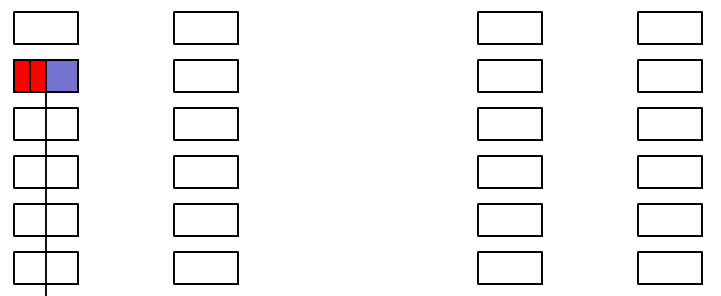
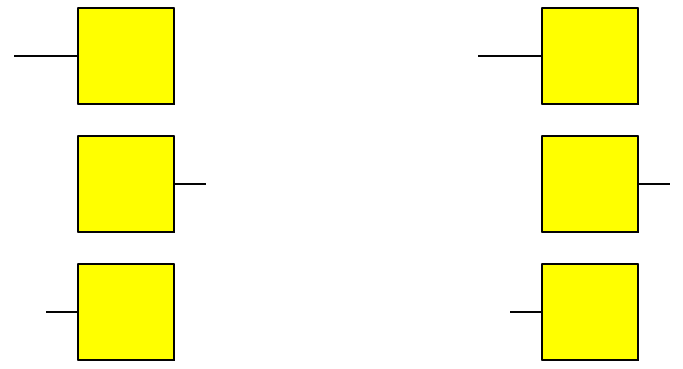

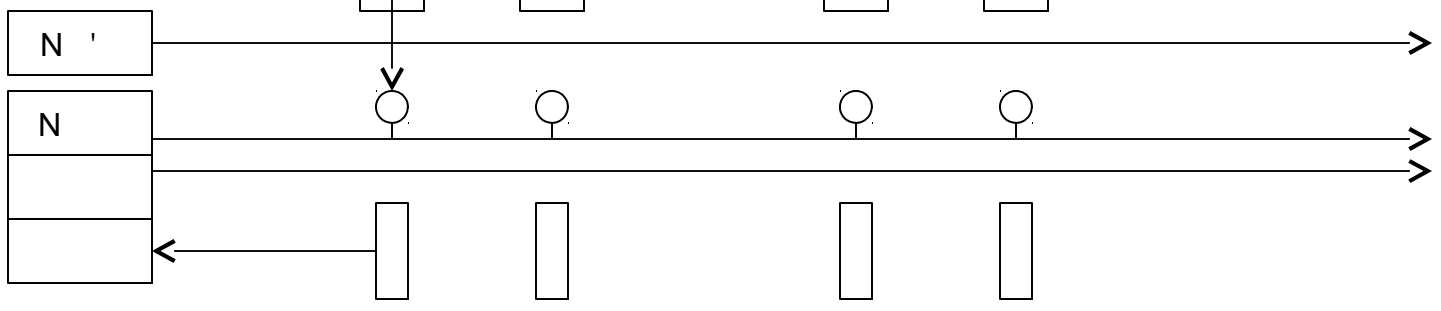
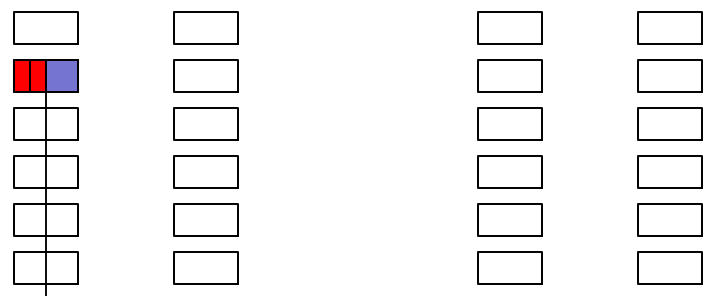
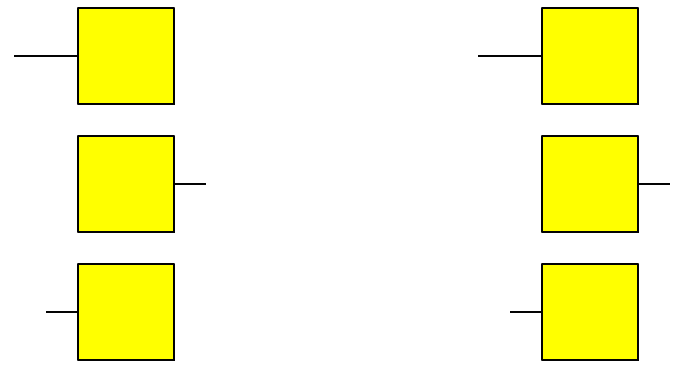

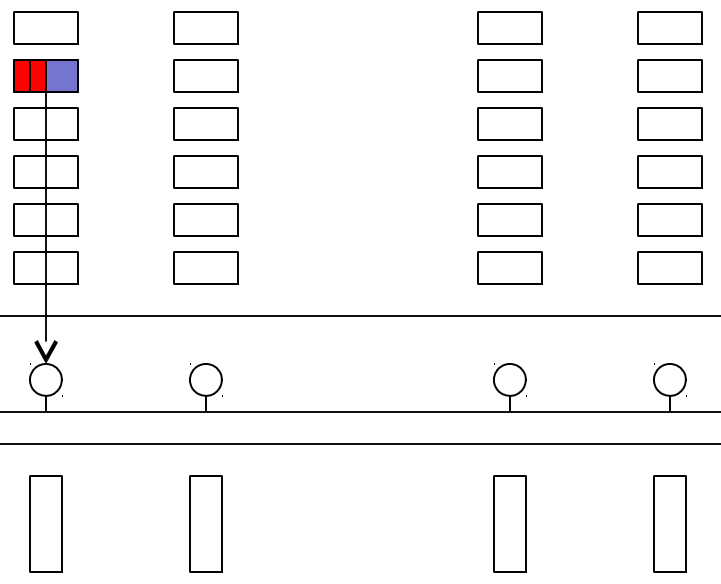
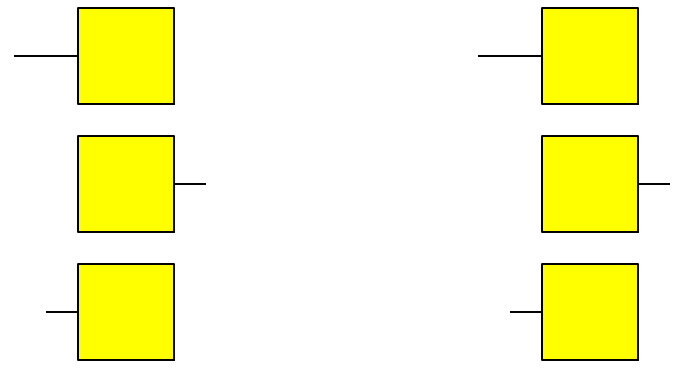

N'

N

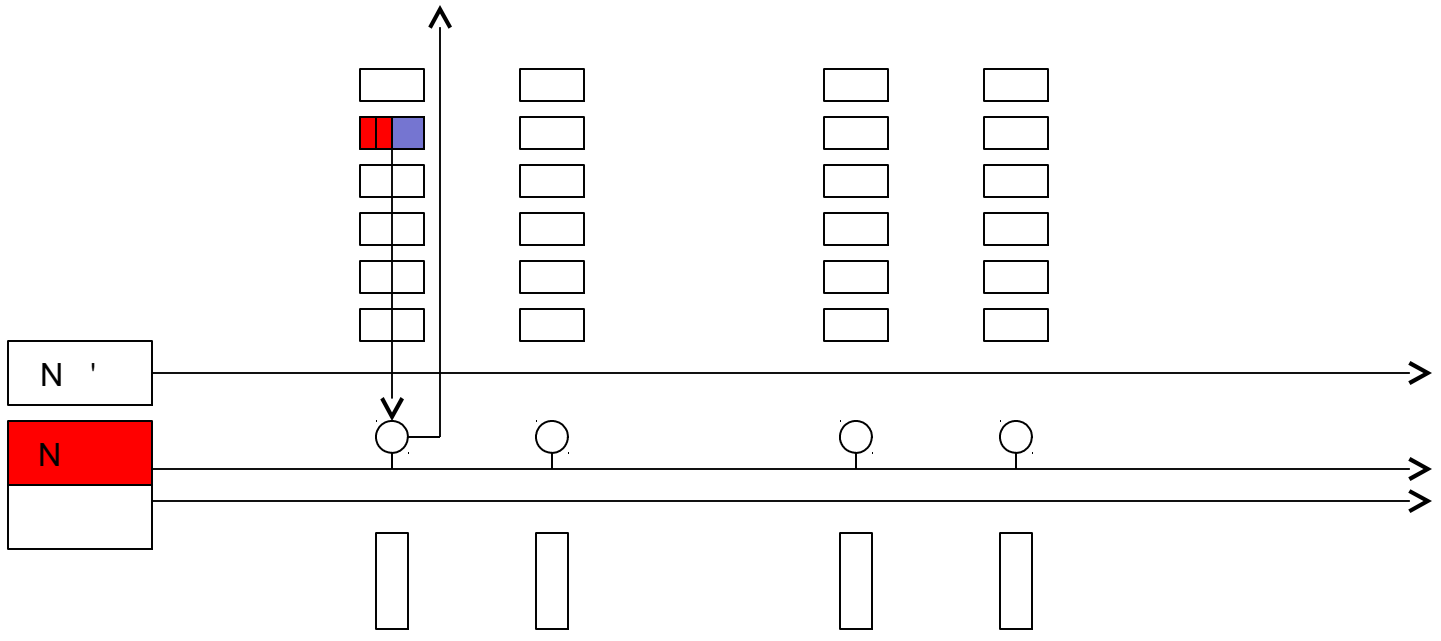
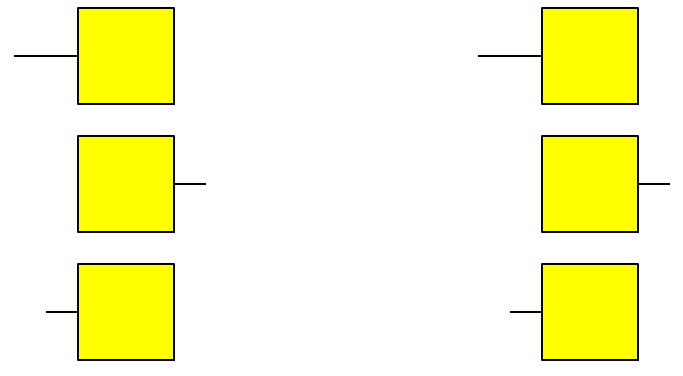

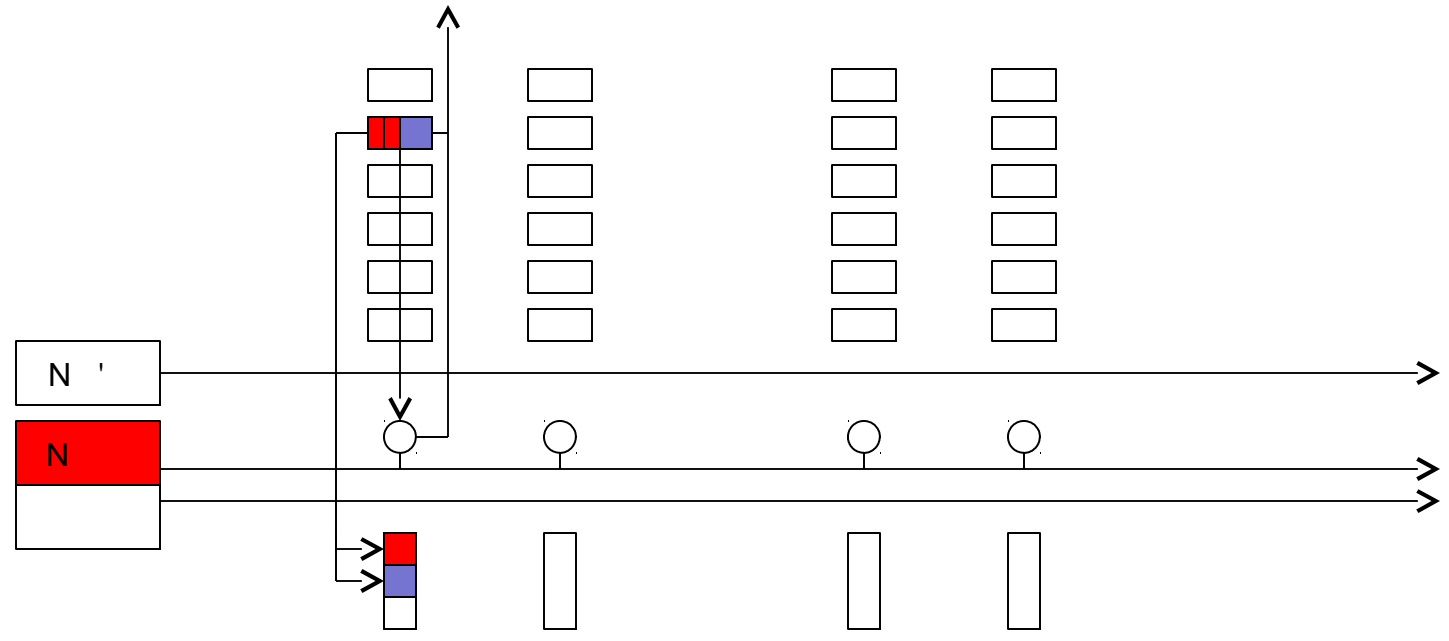
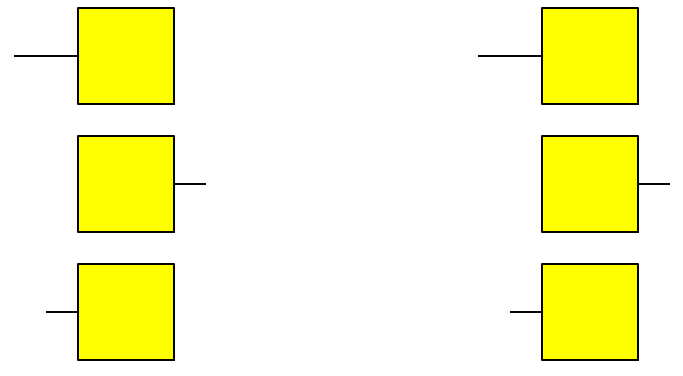

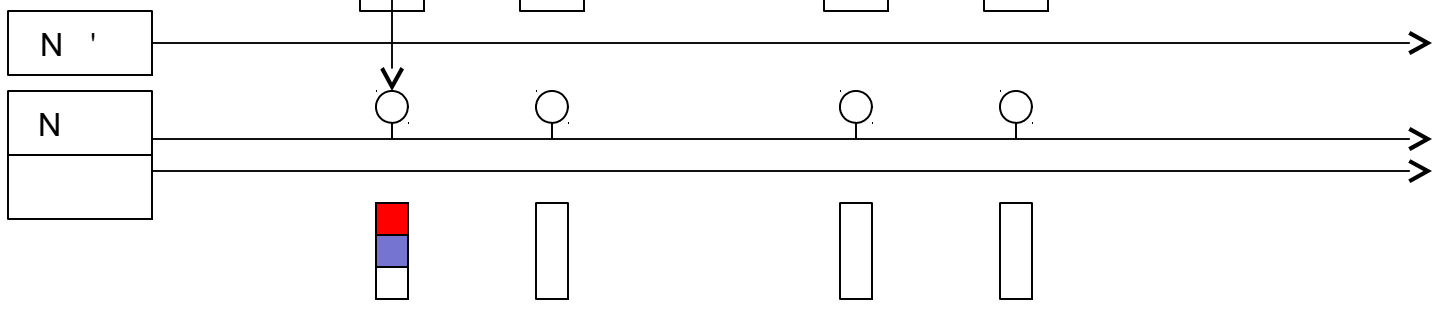
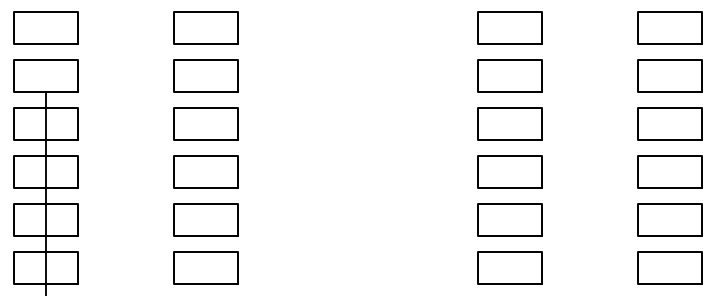
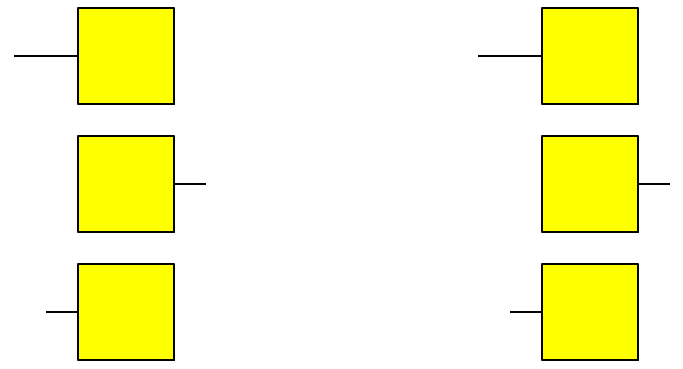

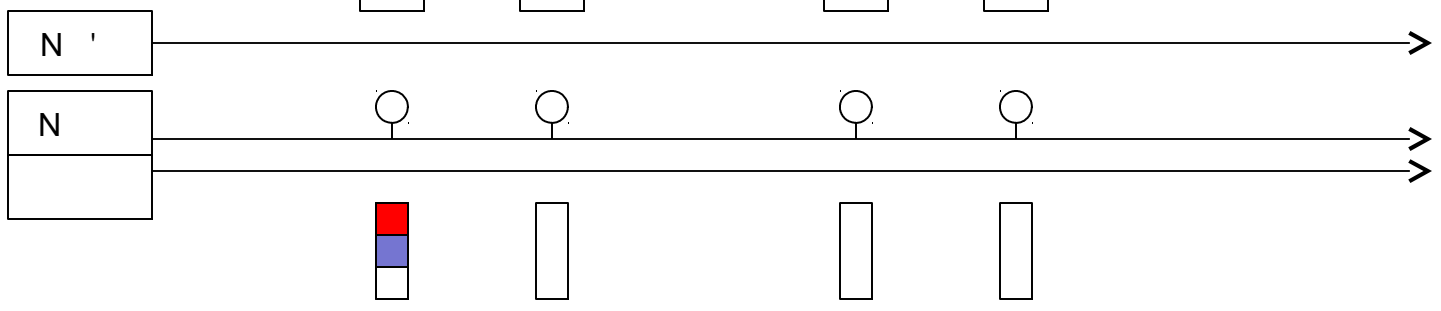
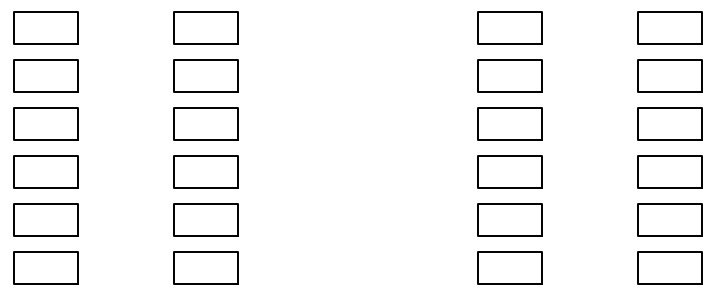
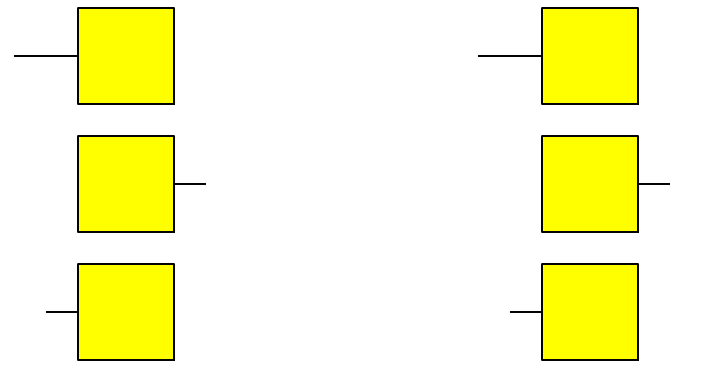

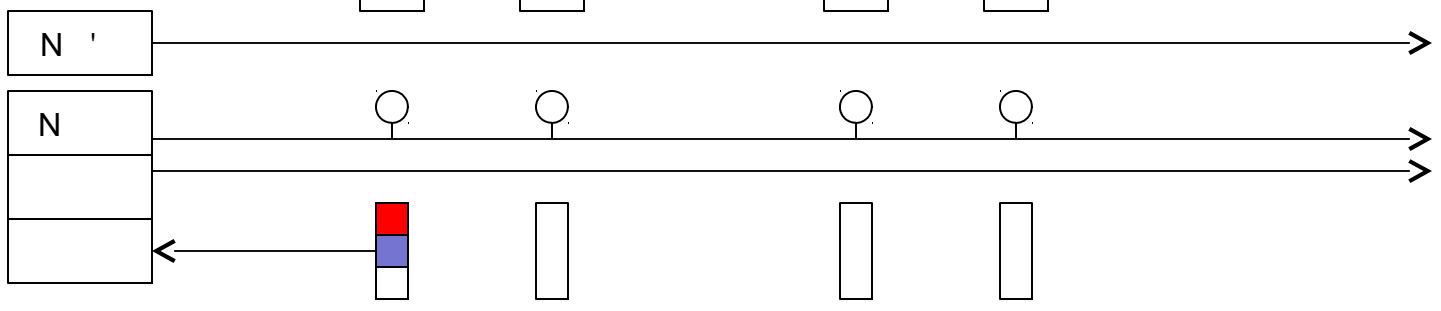
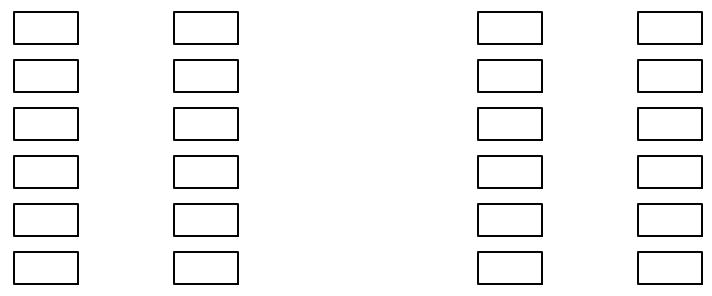
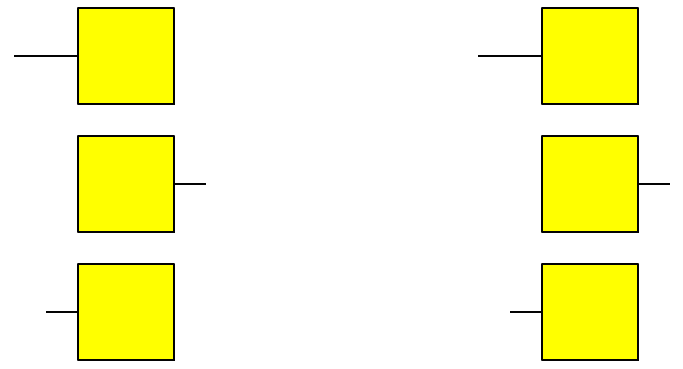

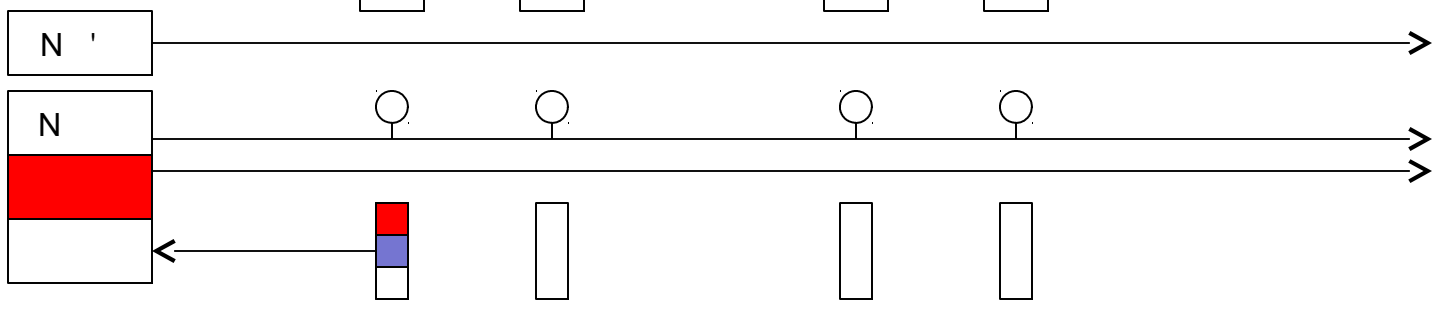
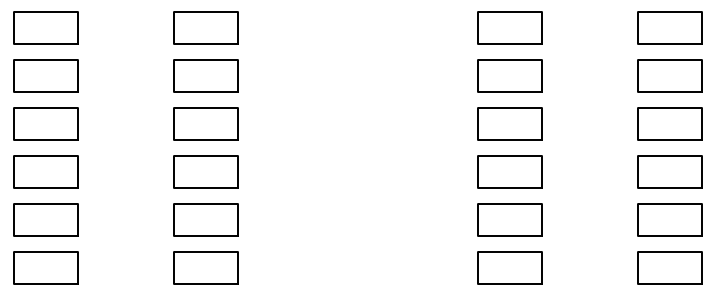
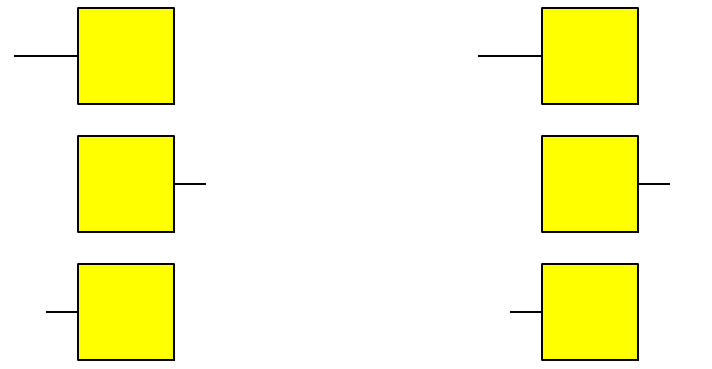

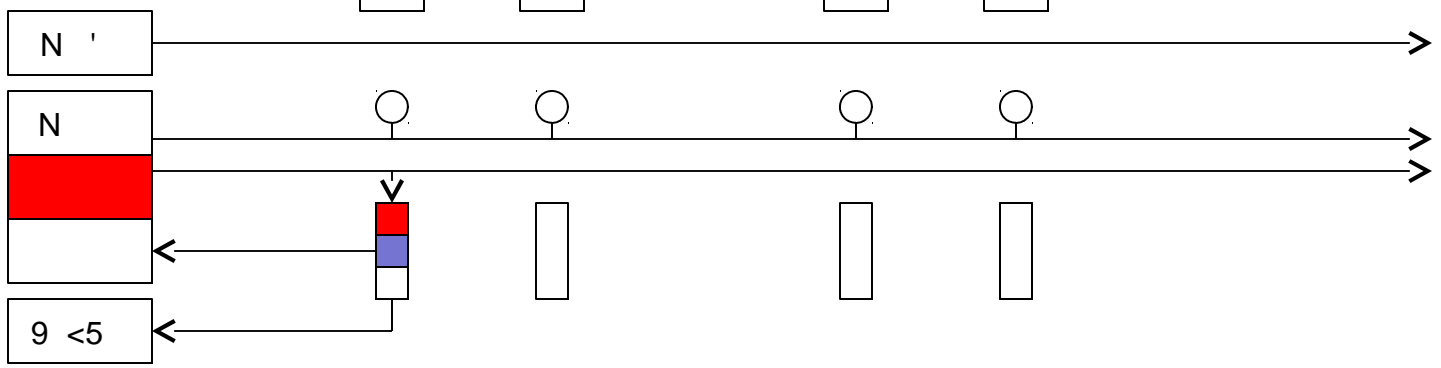
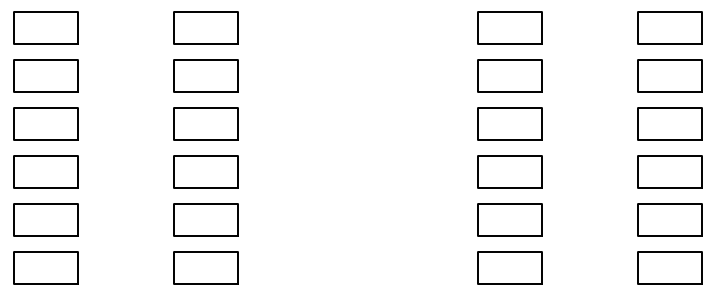
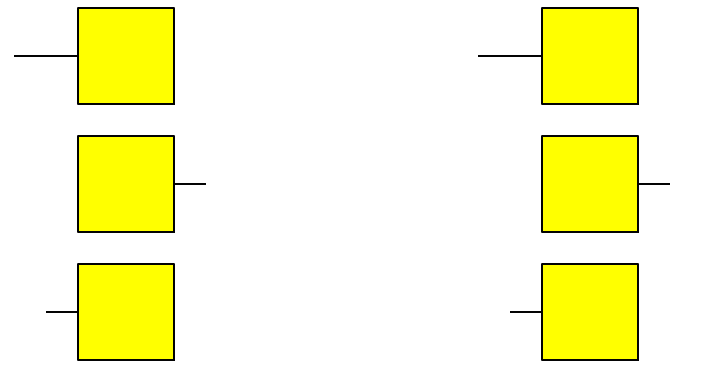

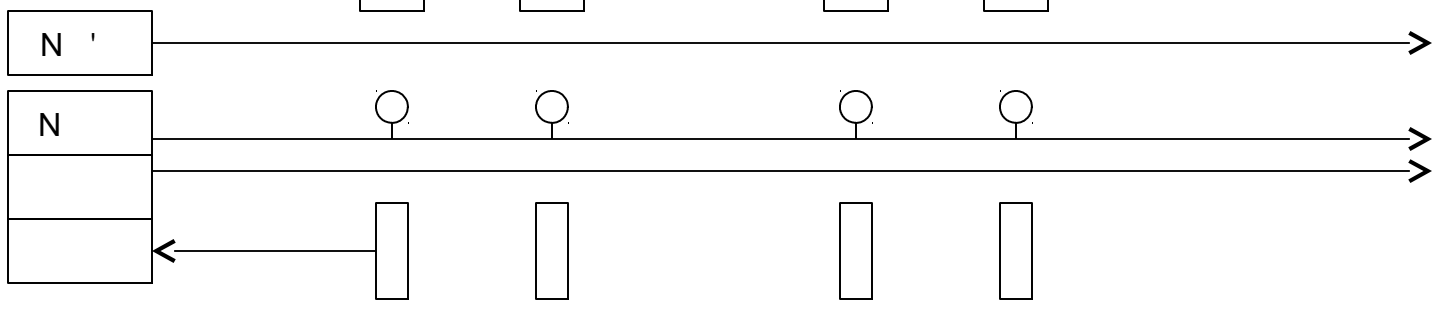
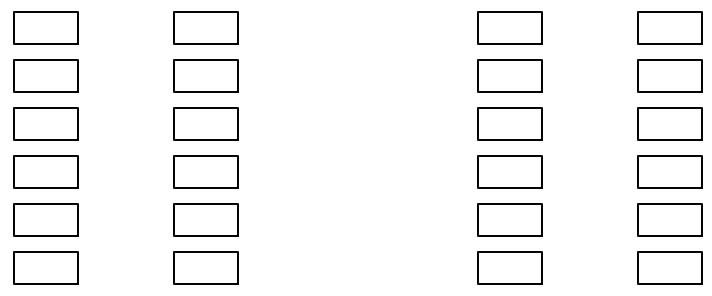
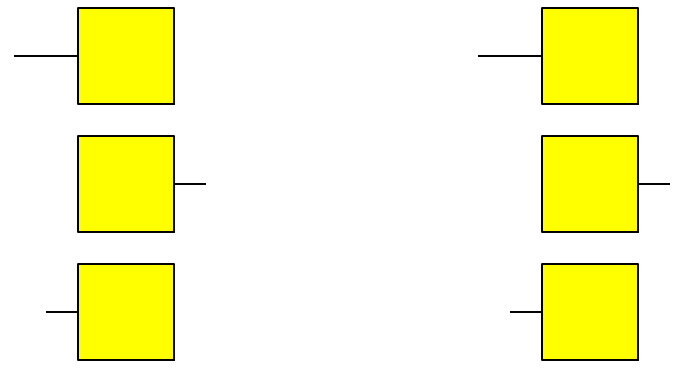

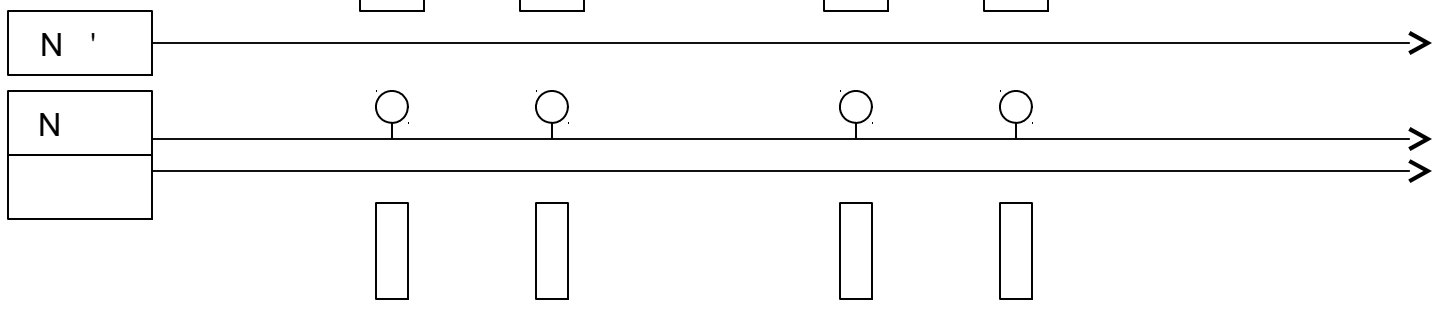
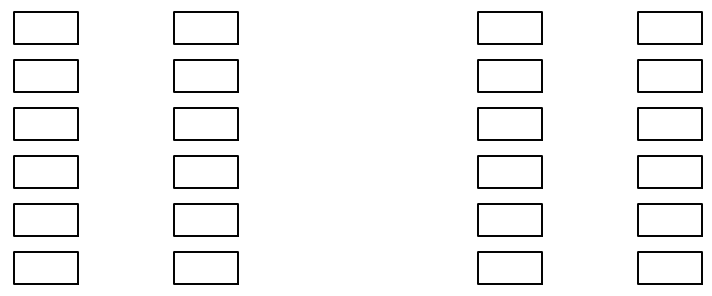
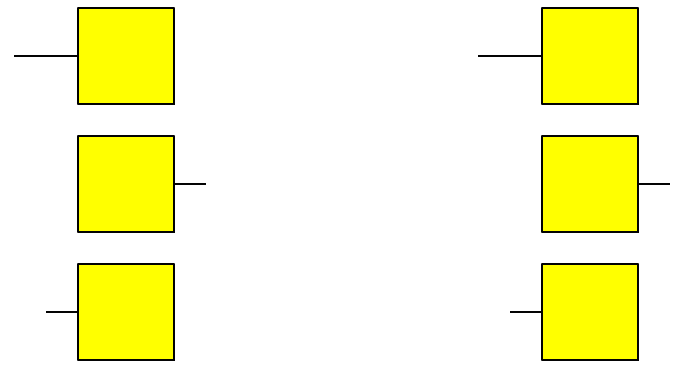

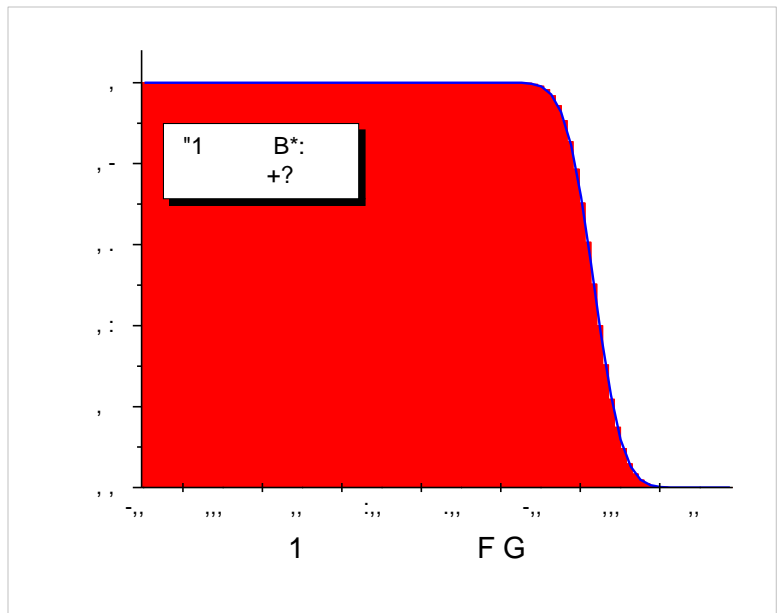
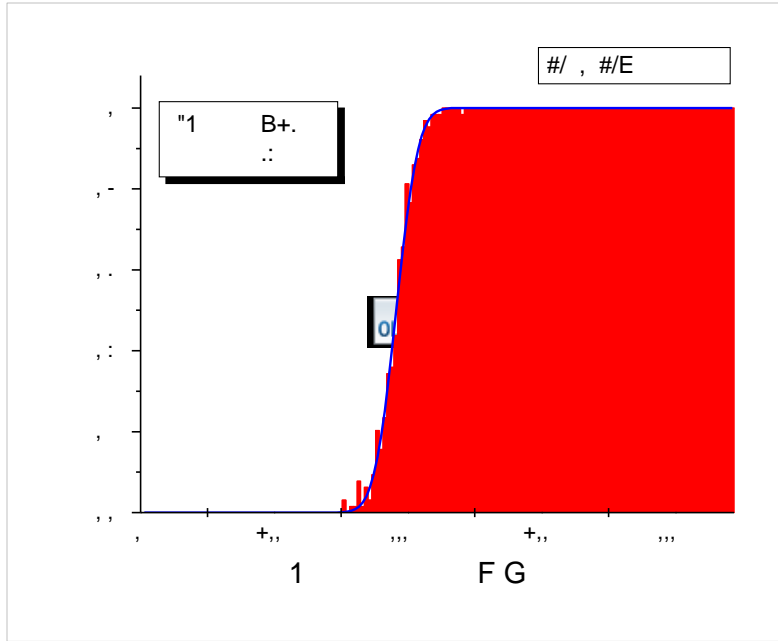

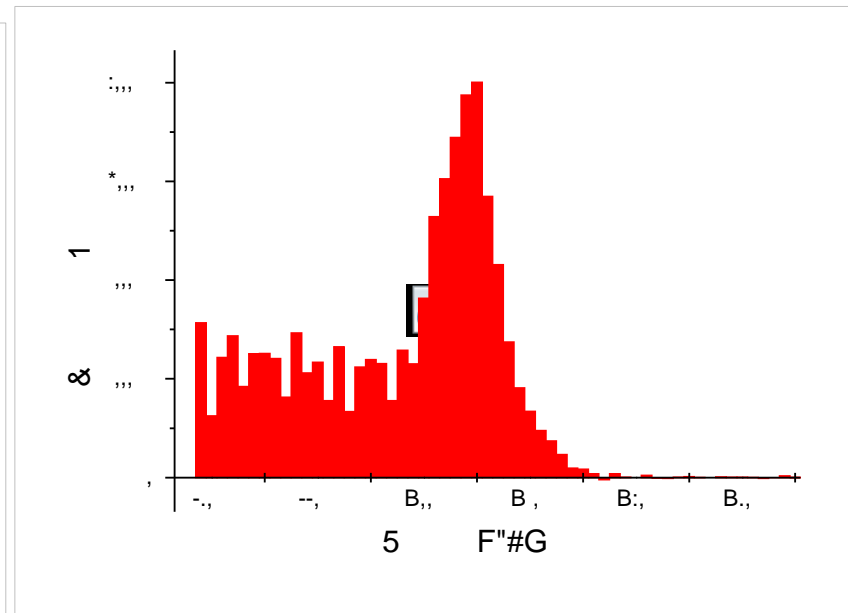
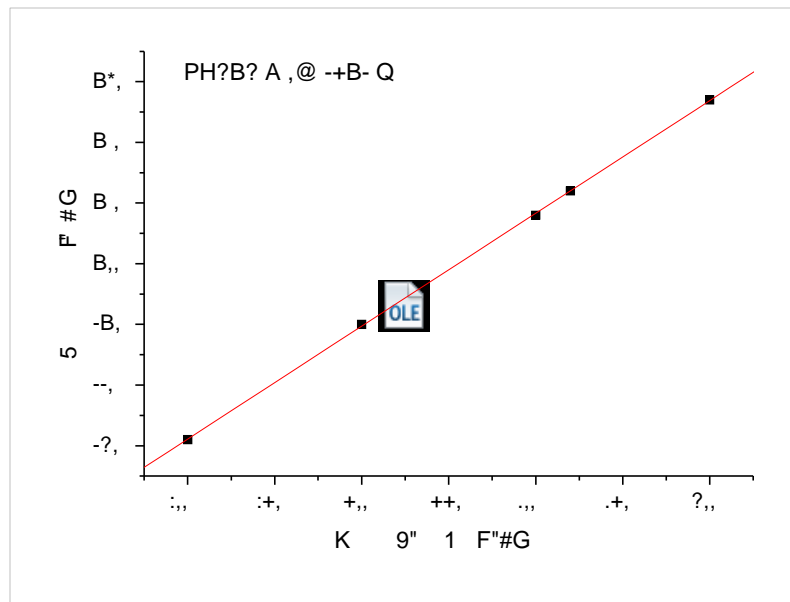

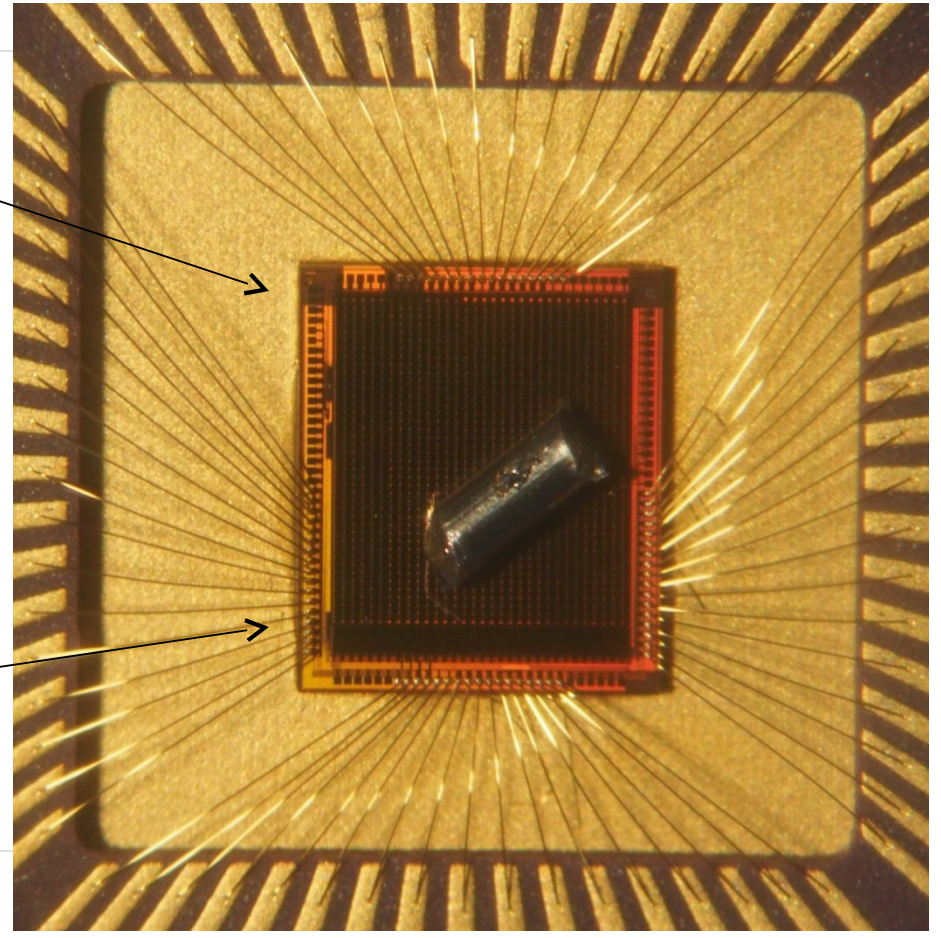
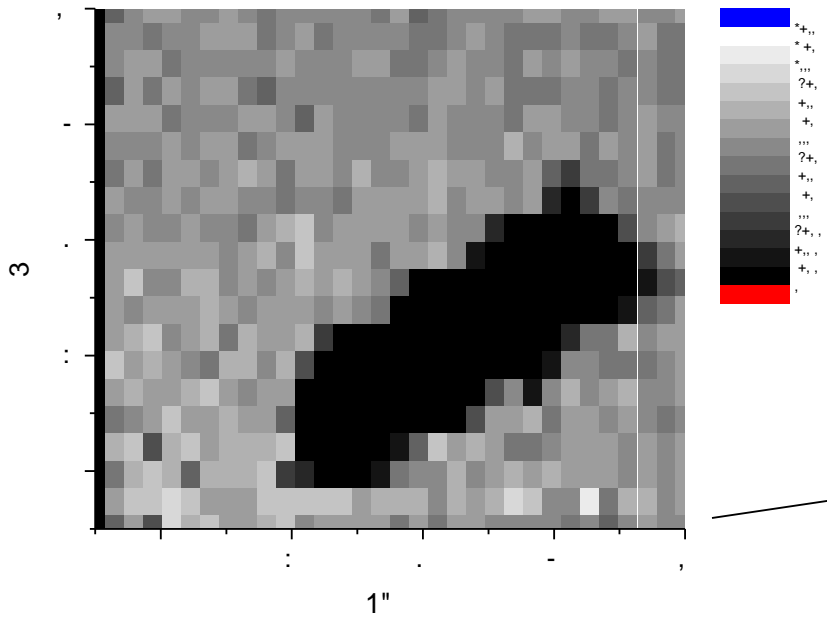



4 5 1 # \$ % & " 0 ' 0
 1 ' (") 1 9 &
 ! 1 ' 1 "
 " 1
 2 4 ' 4 & 9 " 1 1
 9 1 0 ' " 1 % 0

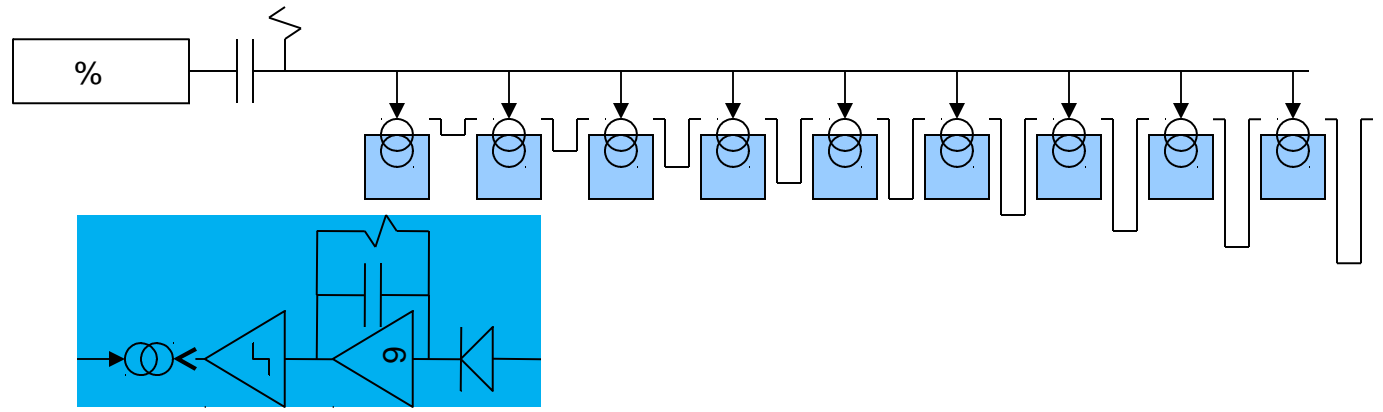



' 14 ' 1 95N9& E; 0 (E; :)

0 0 " 1"

9 4 " ' ' " " 3 9& (@ @

) " 1 1

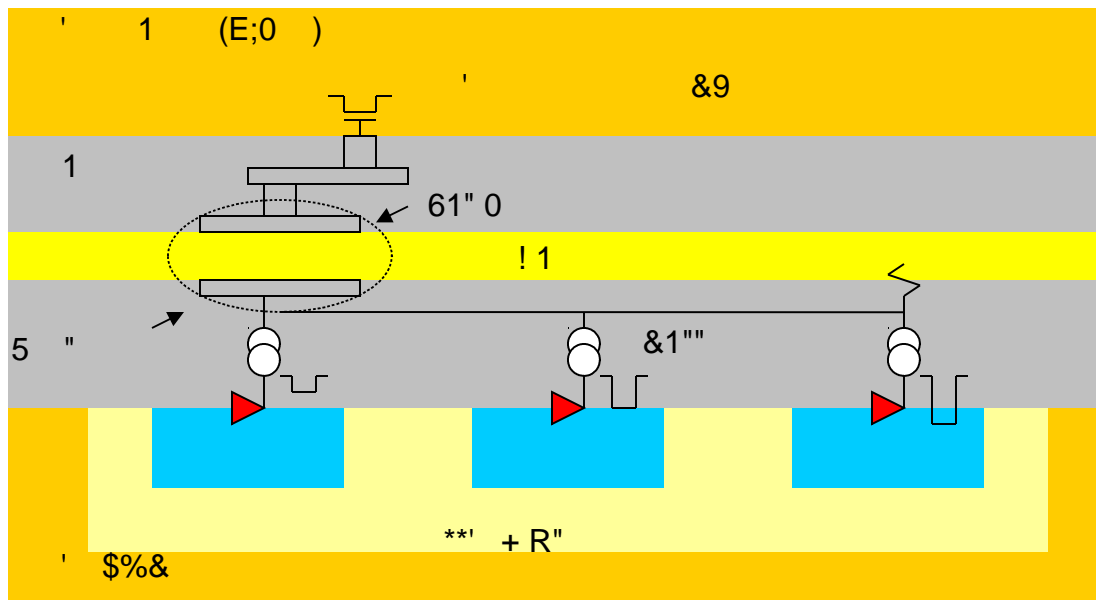



& 14 1" ' (@ @ ,,) 1 " 1 3
 " 1 0 1 ("1)
 9 4 ' (' ') 1 3 " 1"
 (8) 7 1 1 " 1
 N " ' " " 1 @
 1"" " 3 3 "1 1 3
 1 (@ @ - < " < +)

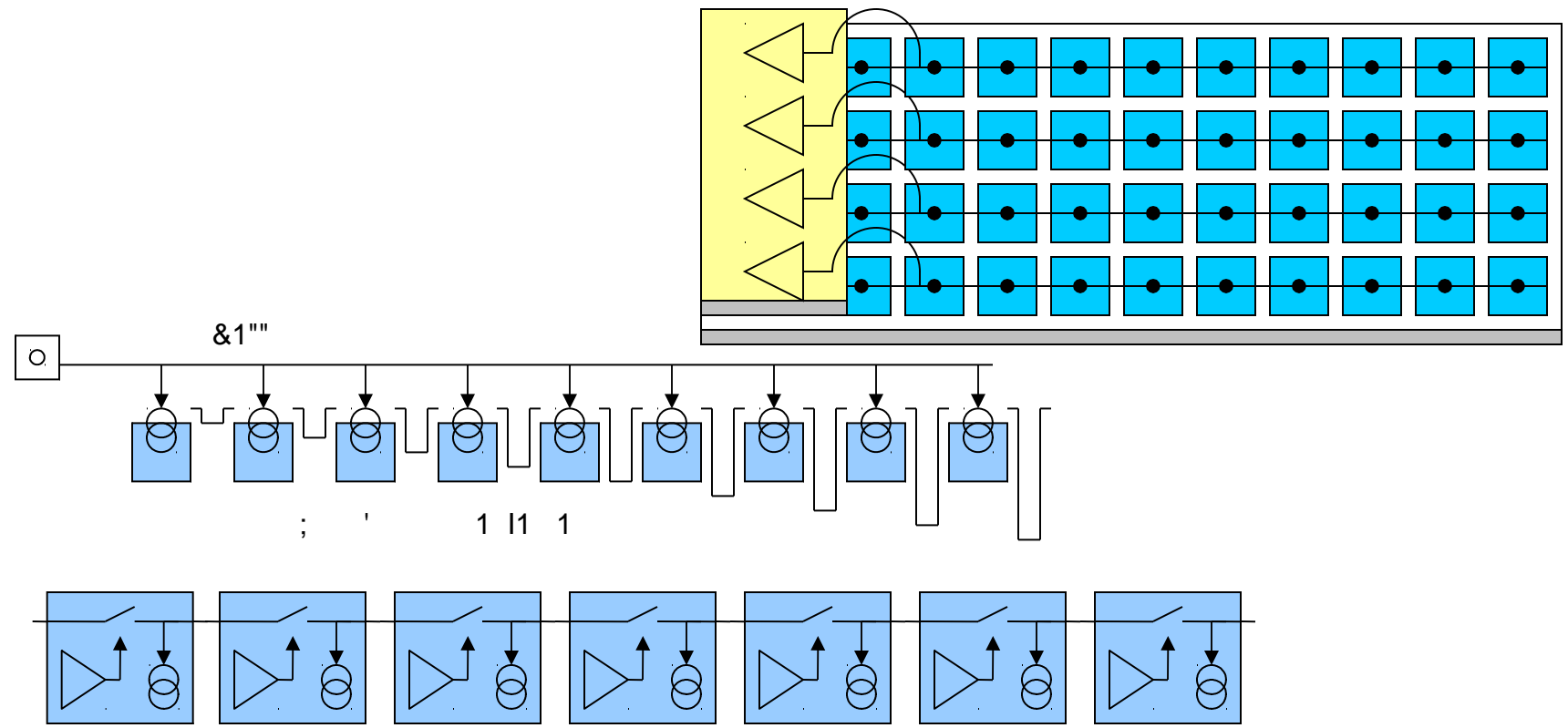



1 K
 9 " C D (0 0)
 1 3 0 ' 0 1
 & 0 1

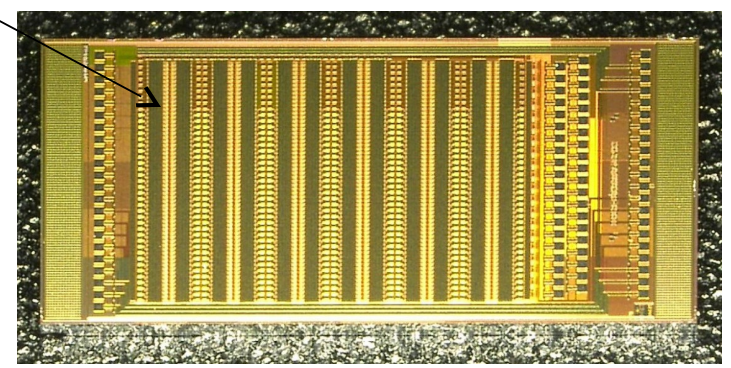
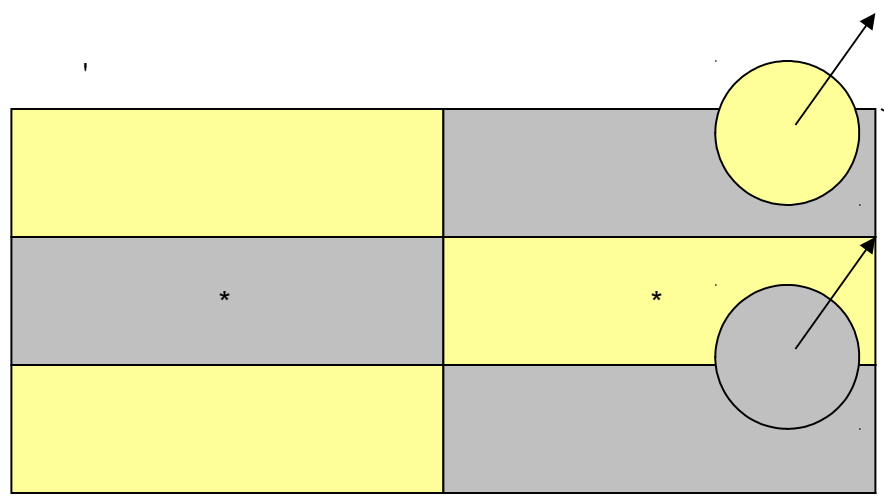



1 K
 9 " C D (0 0)
 1 3 0 ' 0 1
 & 0 1

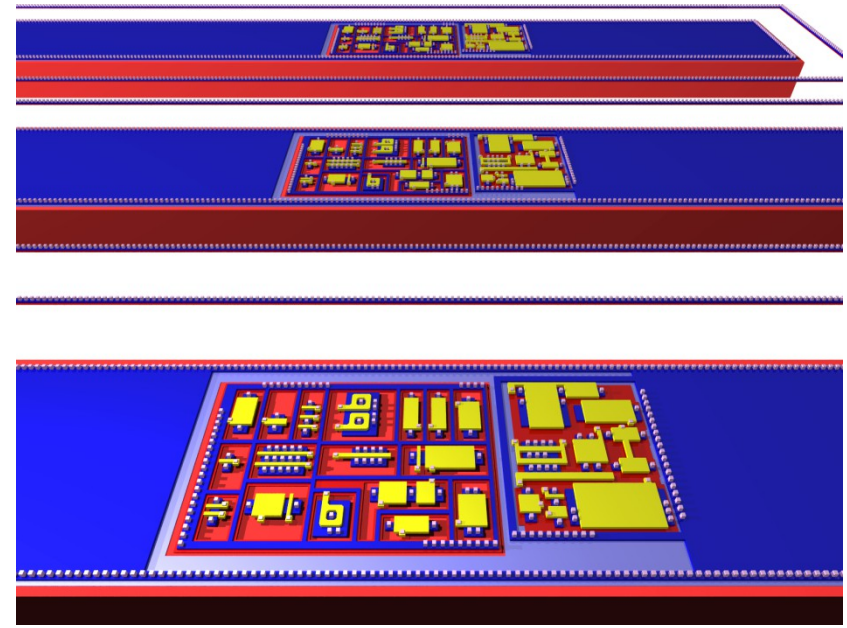
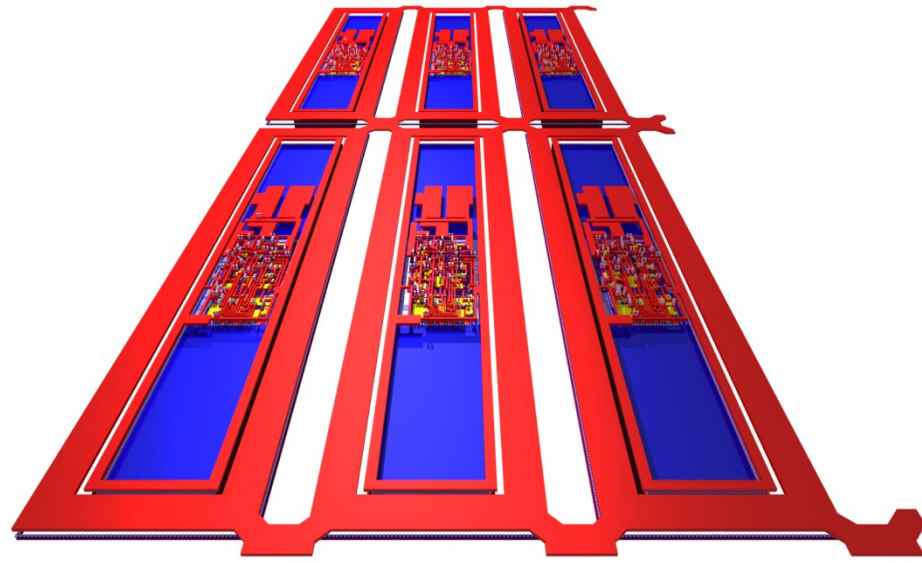



5 3 ' 1 (3 0 1 " " " 1 H= " 1) "

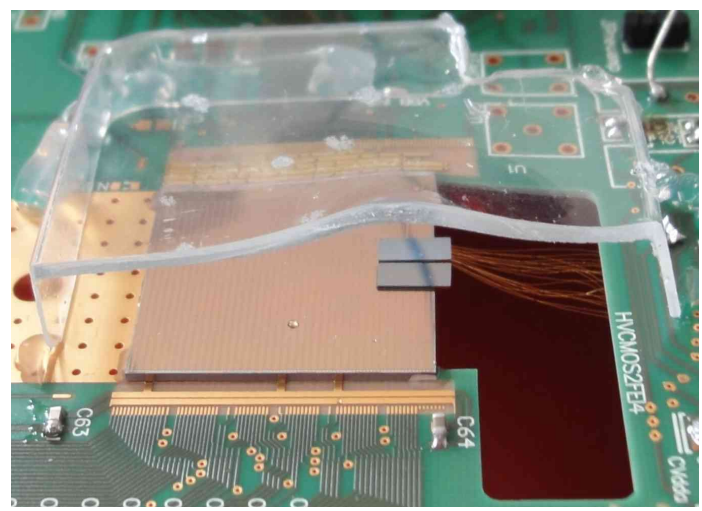

& " 1 " 1 E; :

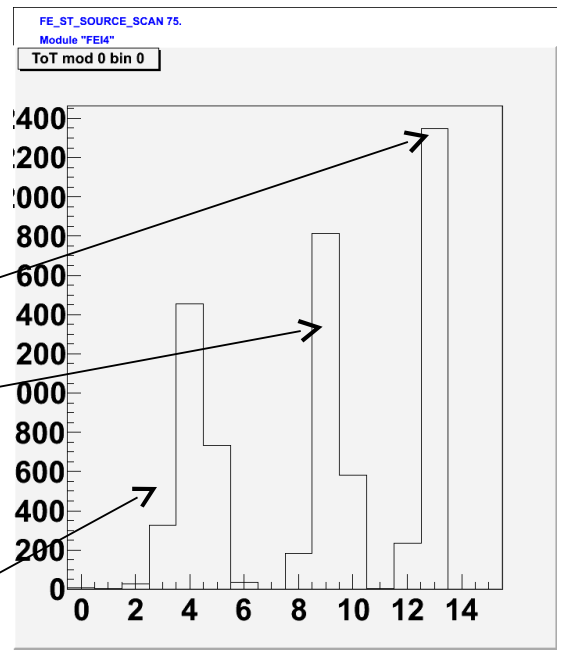
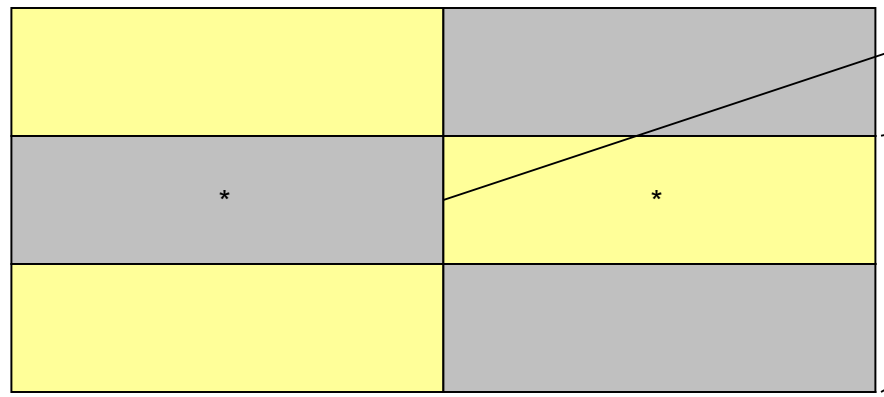



```

& 3 1 1 2
( " " 4 )
5 3 ( ' )
" " 1 " ' 1
$%& "
9 -. $ 3 '0 @ ( 1 1 ? ,
,, $ )
1 ' 4 1 +"# (B, )
1 ;"# (+, ) " " 1
" 3 3 1 1 (>9 +>9) 7
' 7 /$%&

```

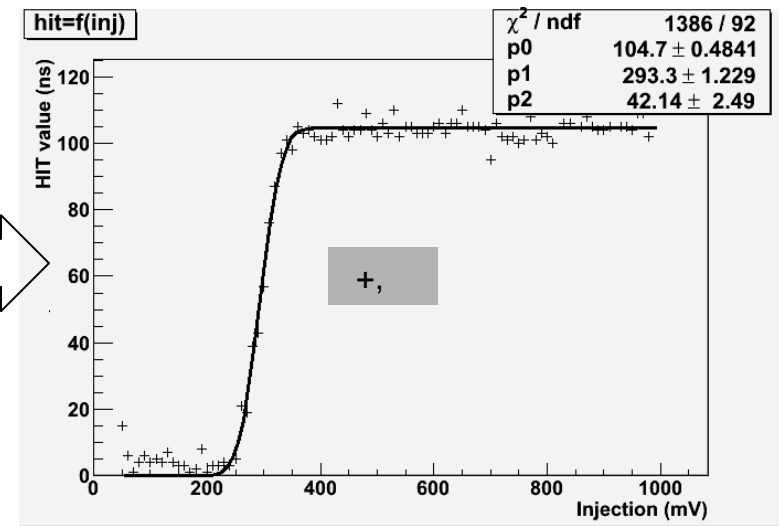
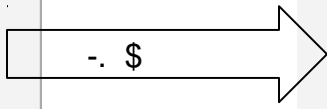
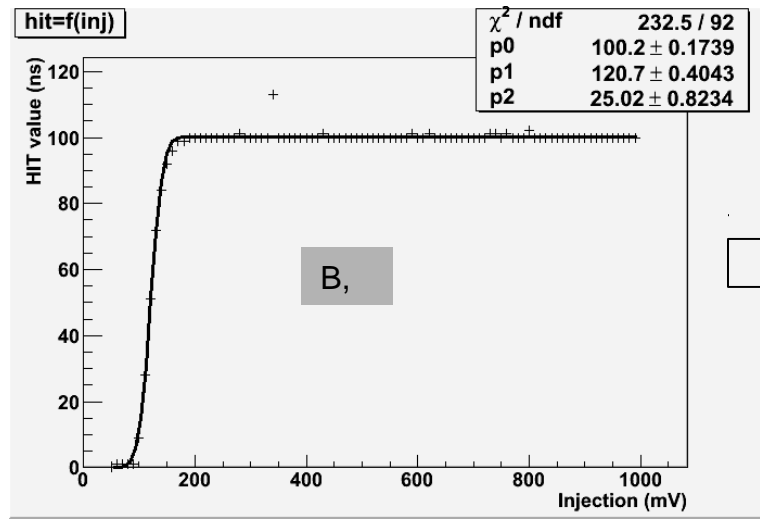



5

" 1

" 1 1

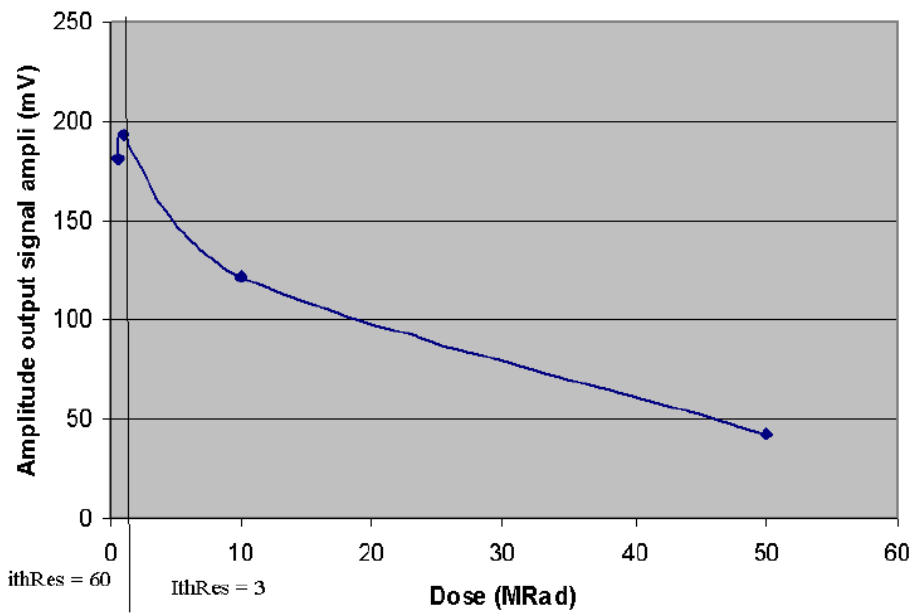

9" 3 '0

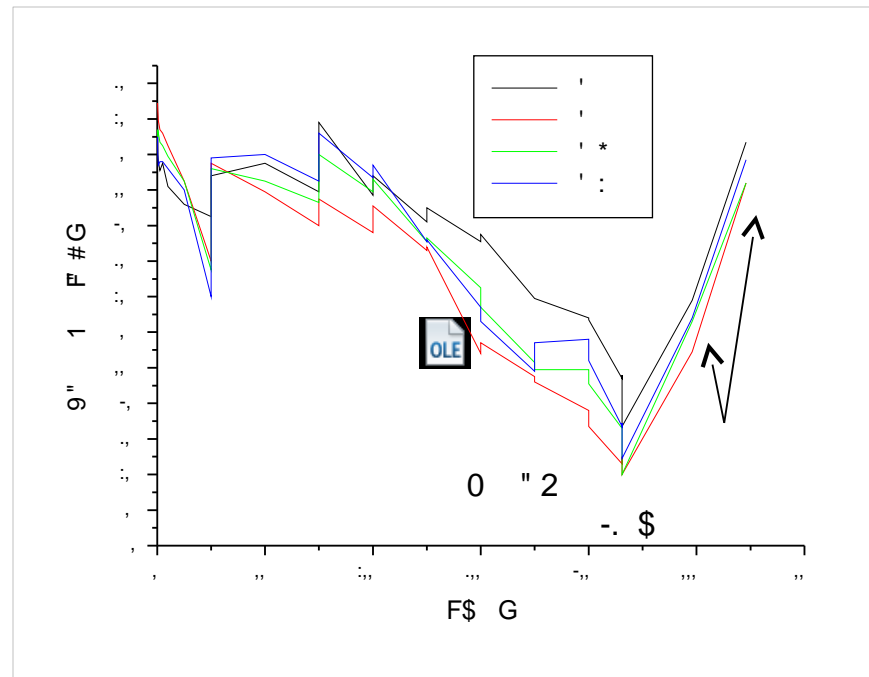

9" 3 '0



& 1

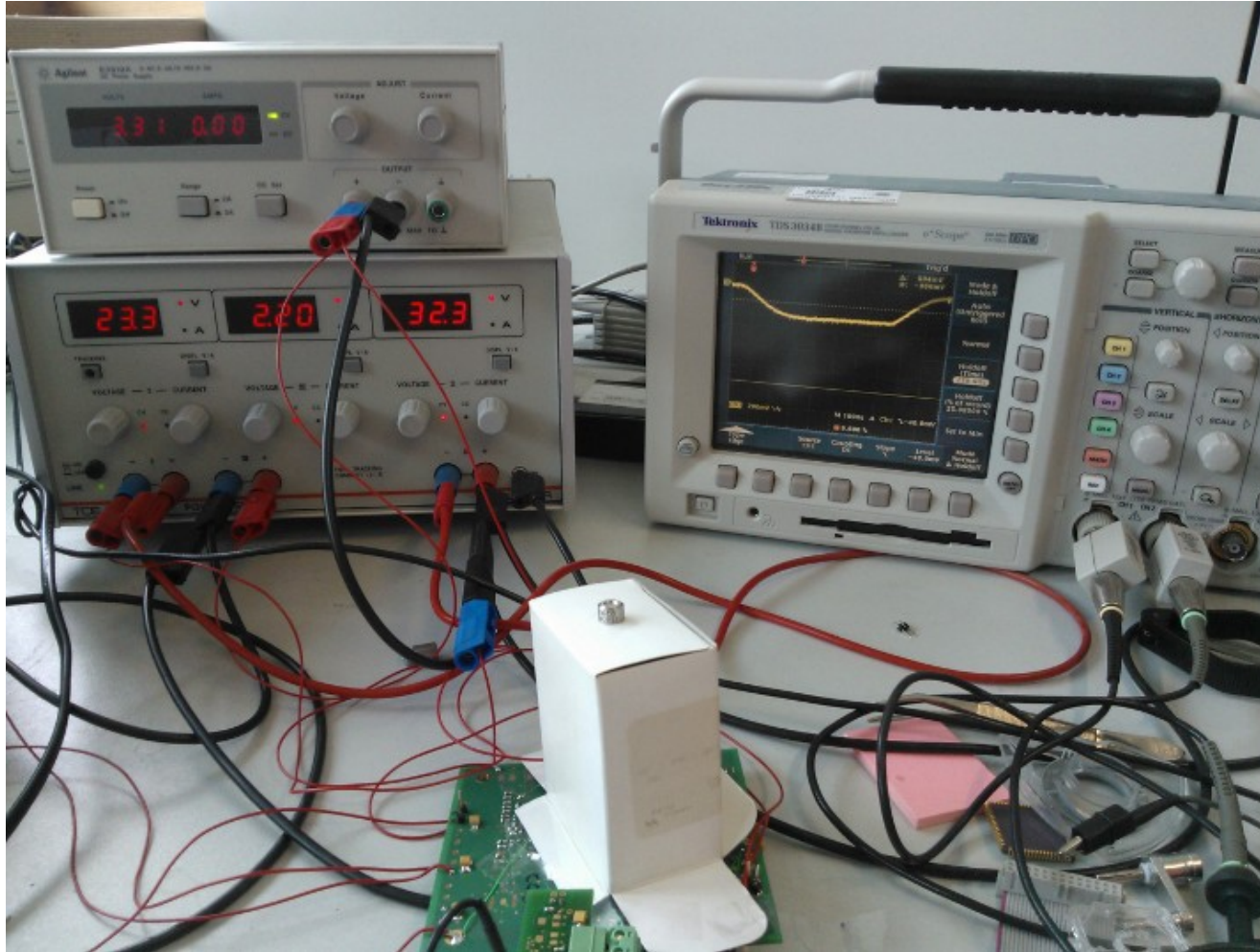



& " 1 " 1

E ++ 

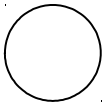
 9

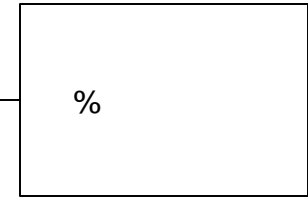
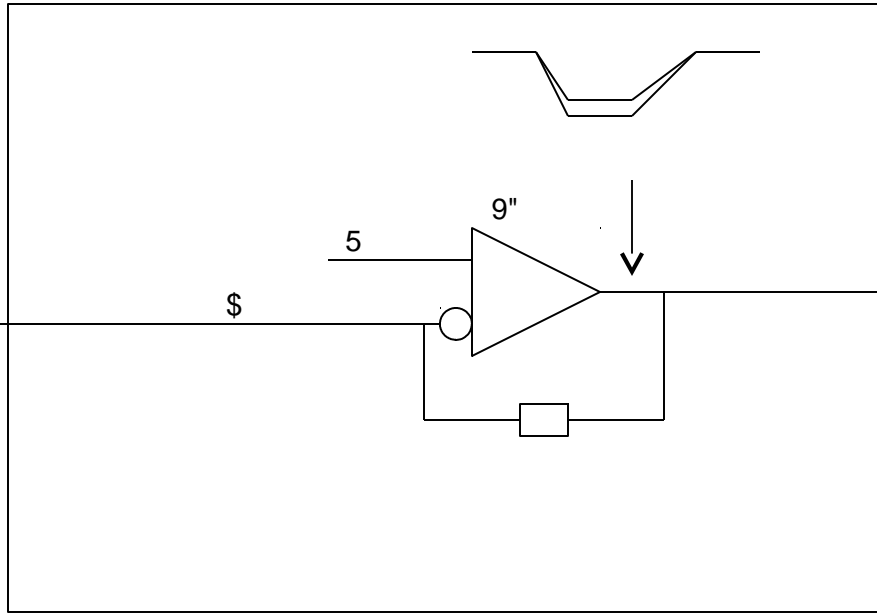
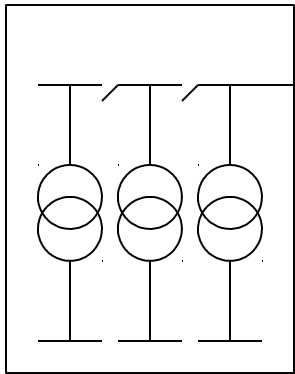



& " 1 " 1

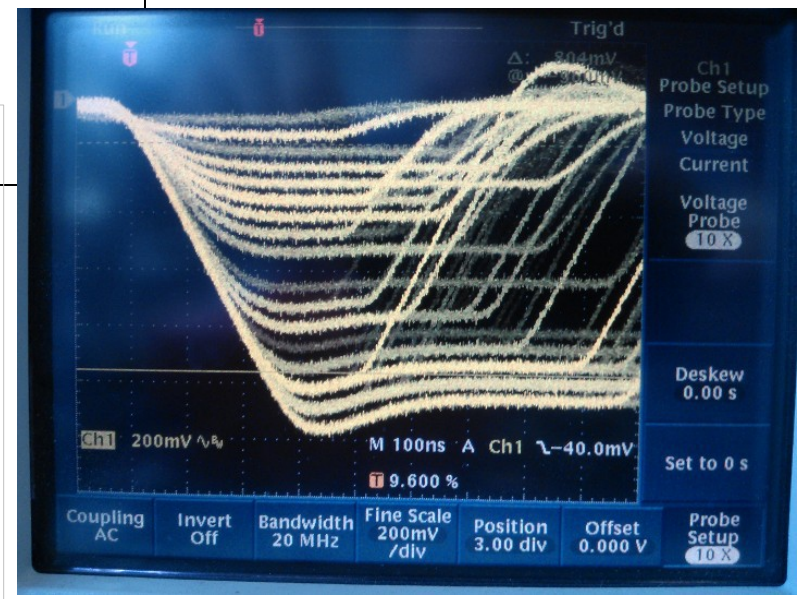
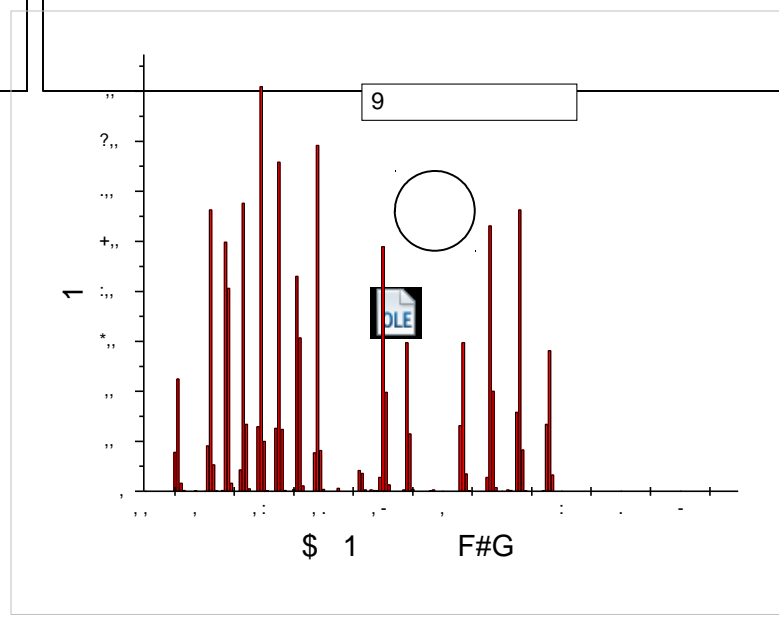
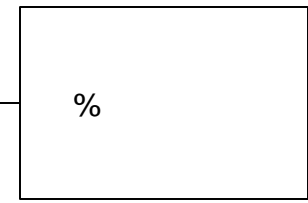
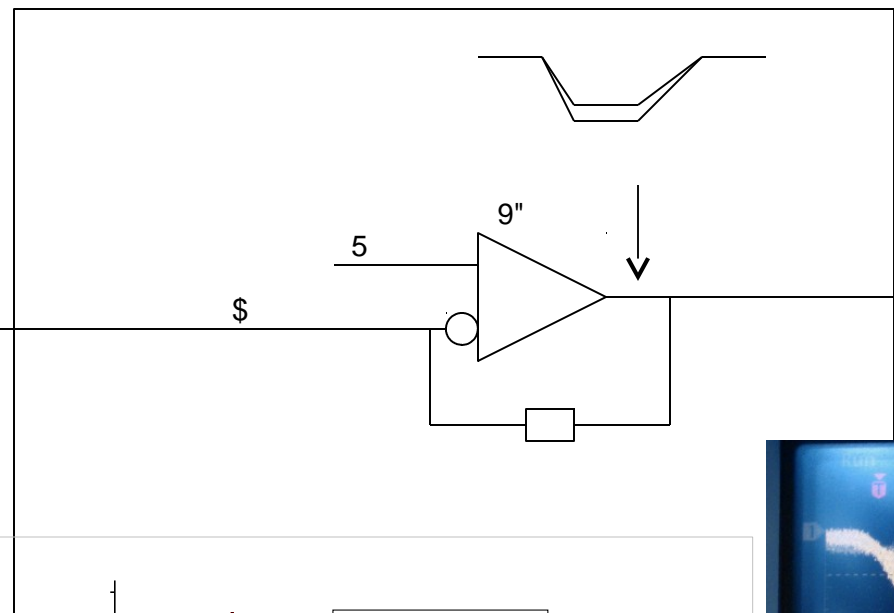
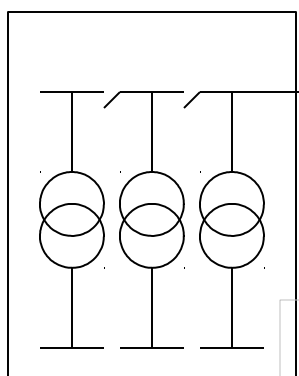
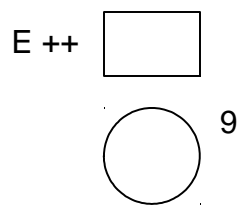



& " 1 " 1

E ++

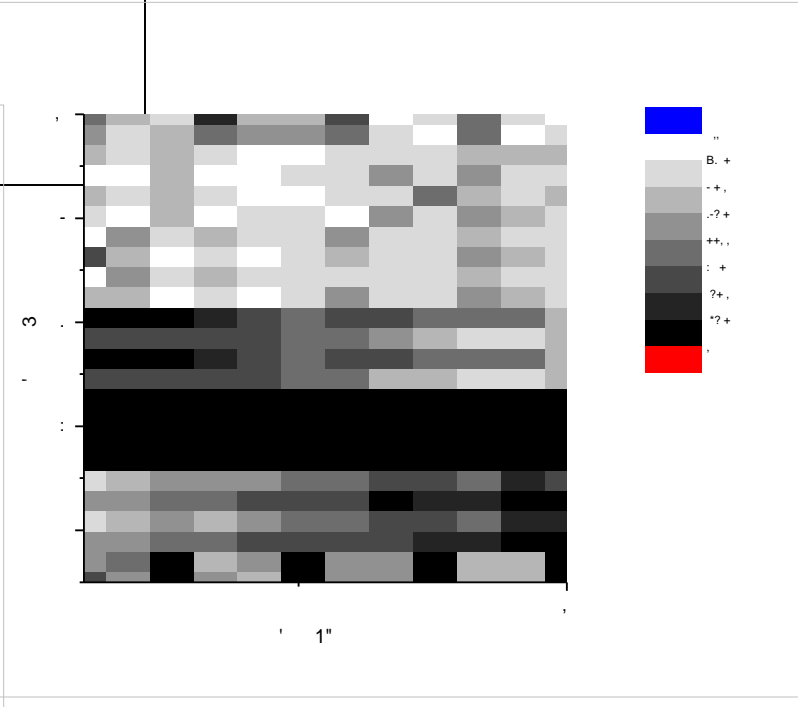
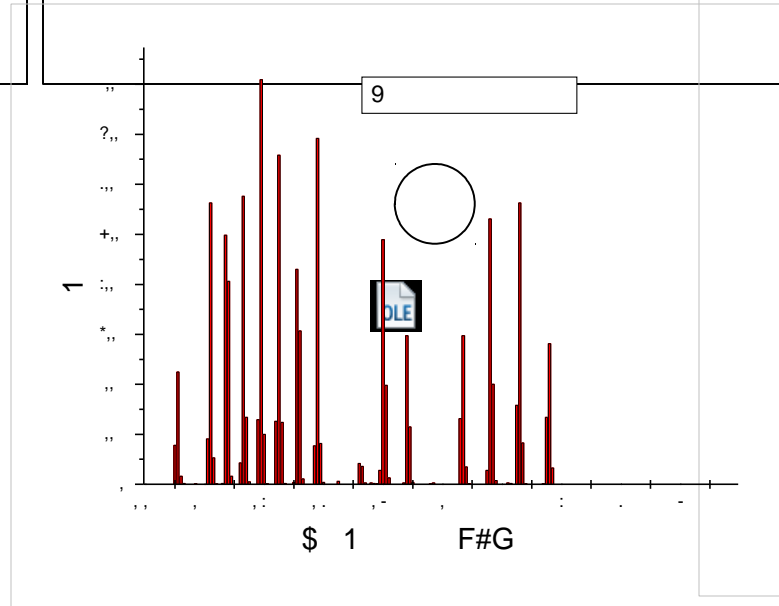
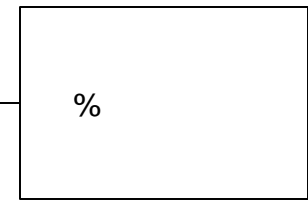
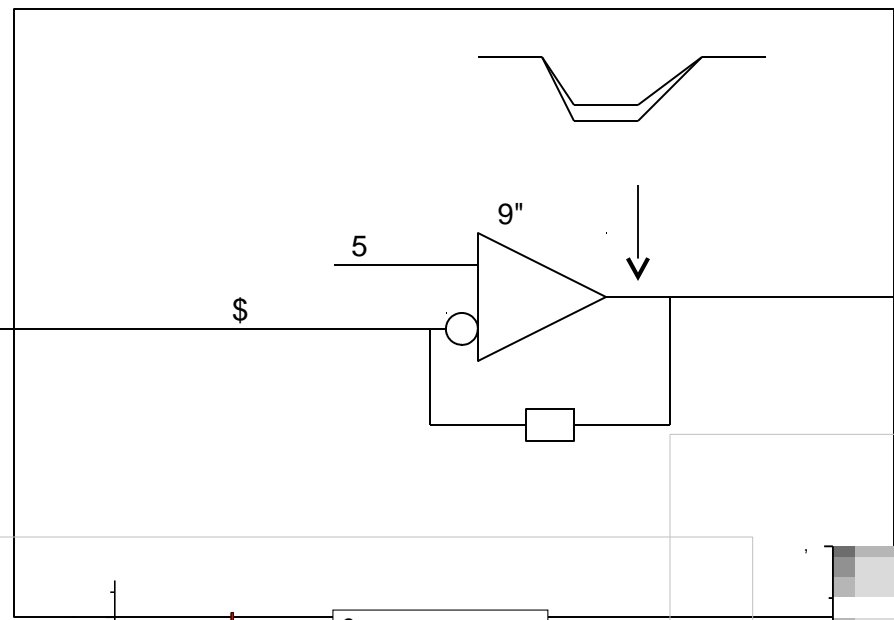
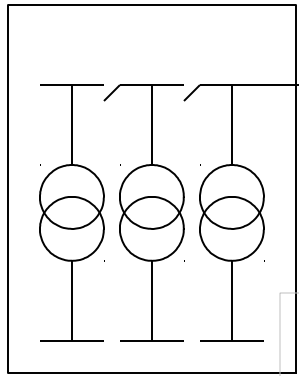
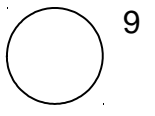
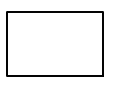



\$%& " " 3
 ! " 1 " 3
 4 \$1* NN N
 1 4
 & 1 3
 3 , . l < " -., \$ 7 1 " 1
 5 " 1 "
 & 3 K 4 1 , :





!



J " 1 (1 ") 1 (1 ") @
 J 5 1 " 1 3 1 2 " 1 K @
 J 5 " 1 " 1 55@

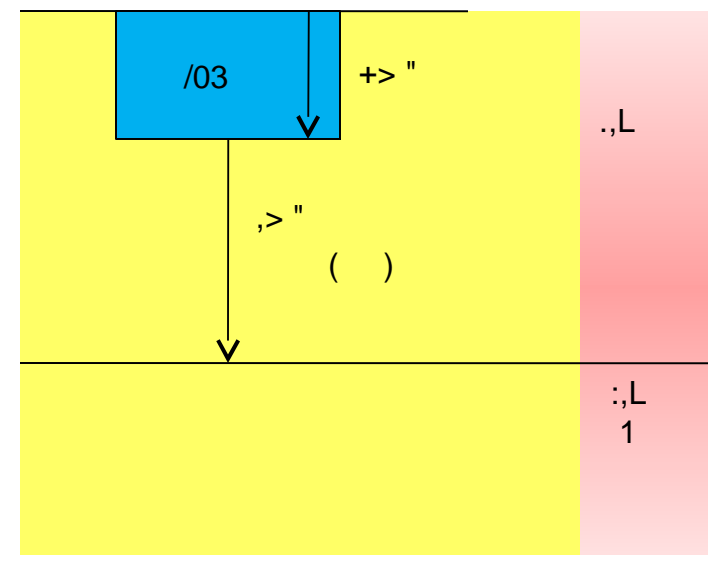
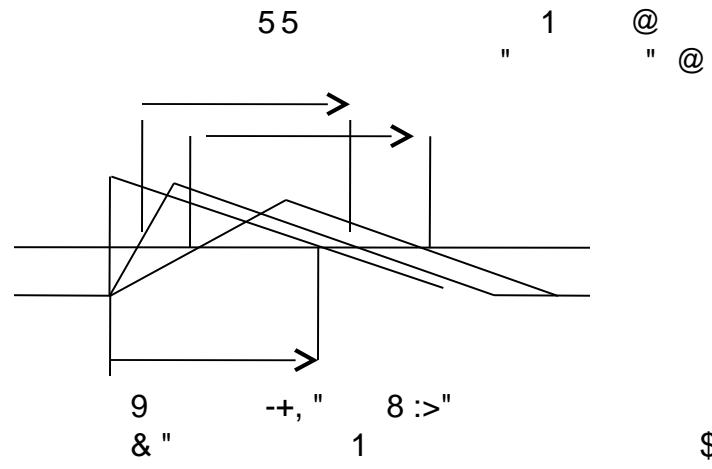
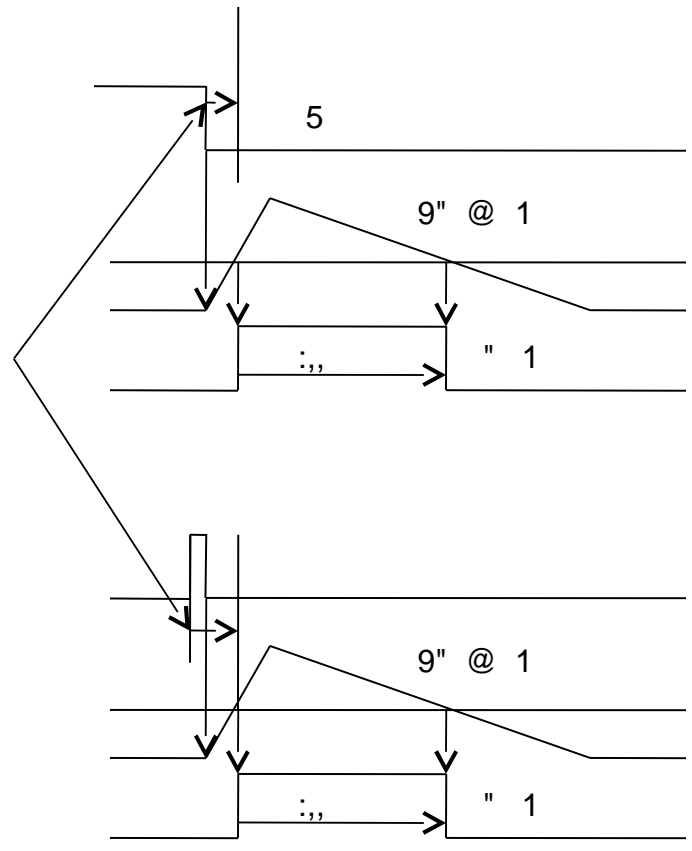



" 7 " 3
/ " 1 1 1 @

K @

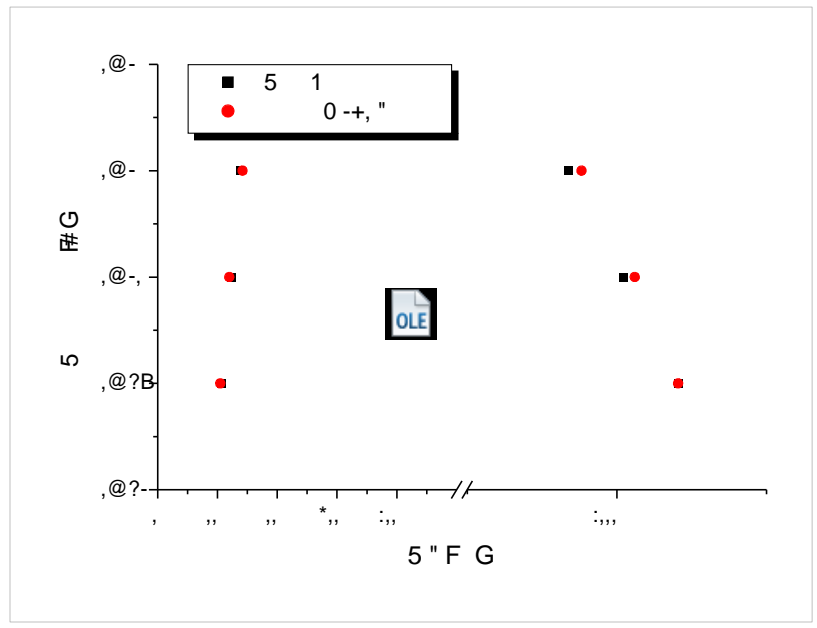
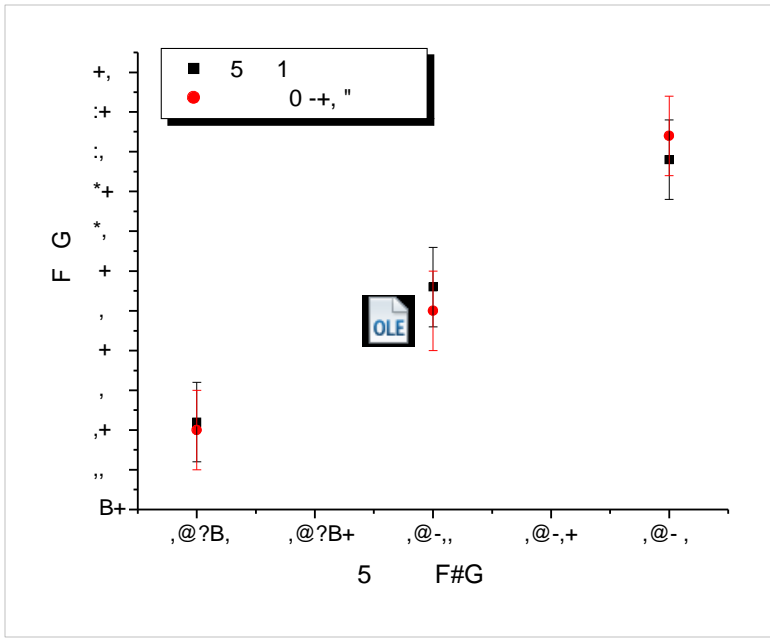



' 8 -, ', μ" '

S 1 T1 4 ,,

U & 4 8+, μ"

VU 1 " 1"

EW 4 @B"

?+ \$ '

& SU !

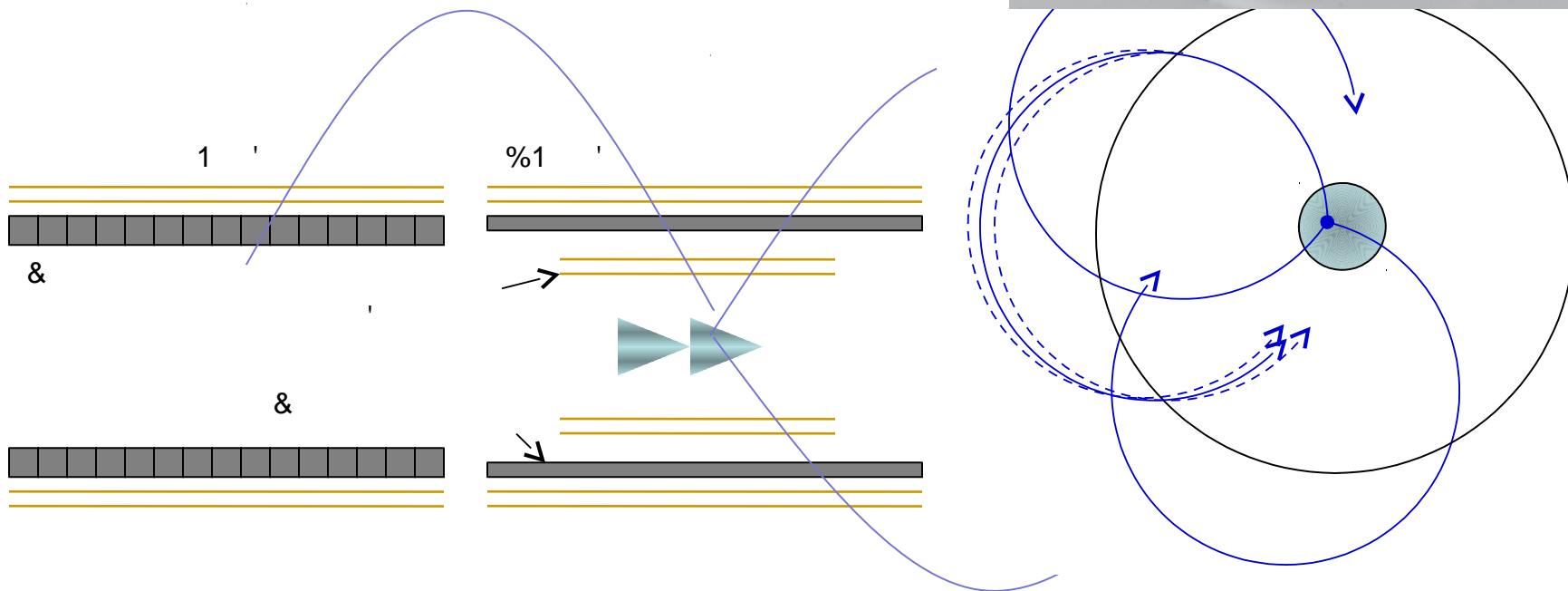
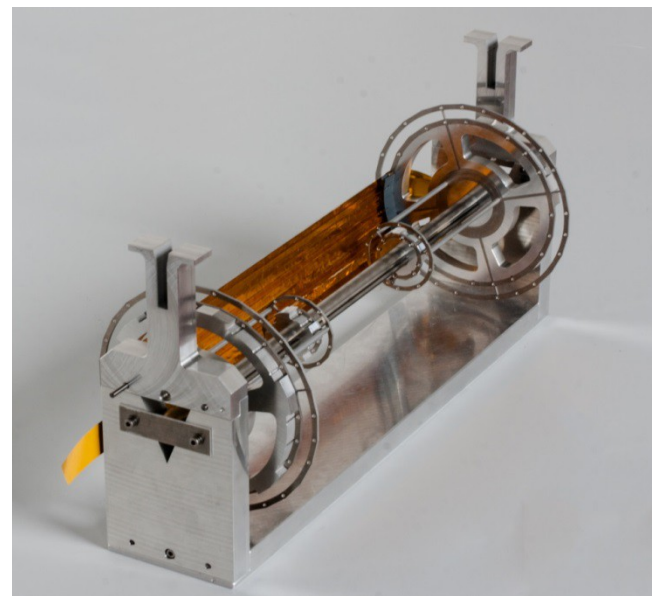
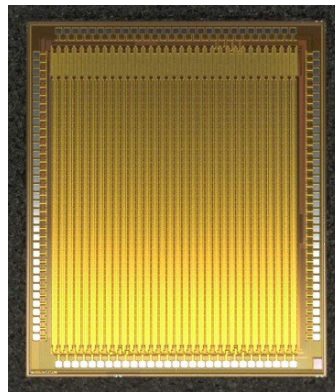



' 8 -, '-', μ" '

S 1 T1 4 ,,

U & 4 8+, μ"

VU 1 " 1"

EW 4 @B"

?+ \$ '

& SU !

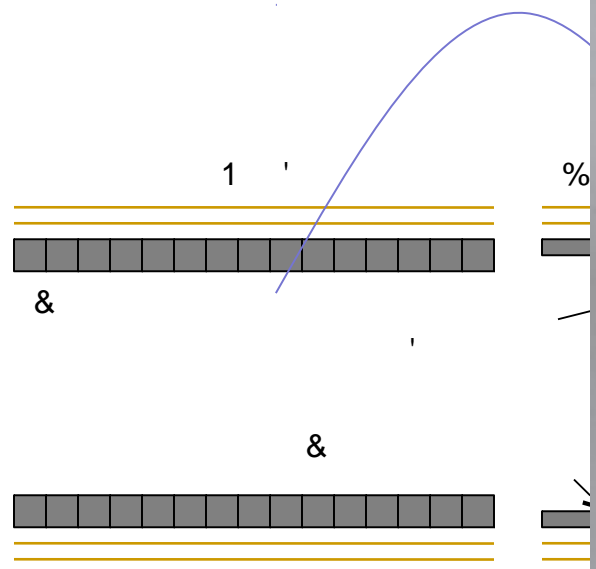



N1" W 3 1 1 9

; " " "# 11" 1" # 11 21 " " " \$ 1 21 3 & 1 „>" U " 1 "9 1" 1" W

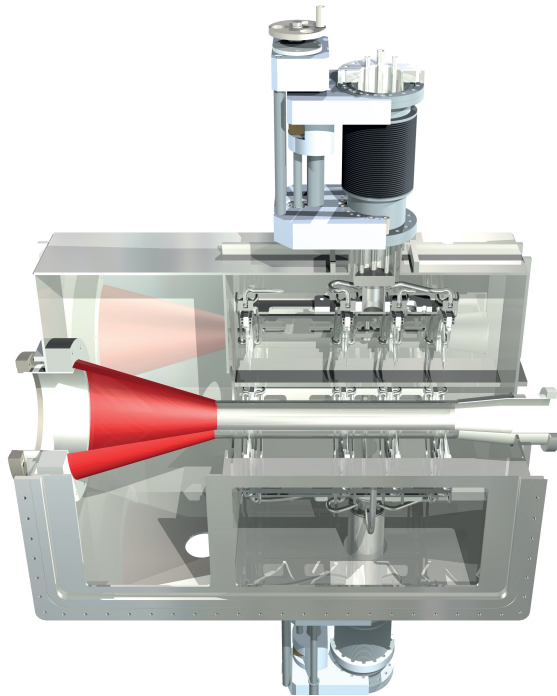

& 0 "

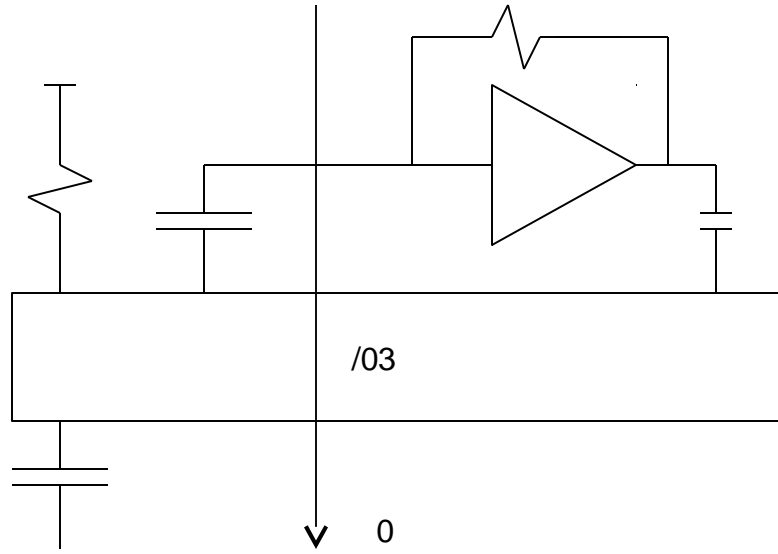



9 1" 4 # H - ' , : "<
5 H --

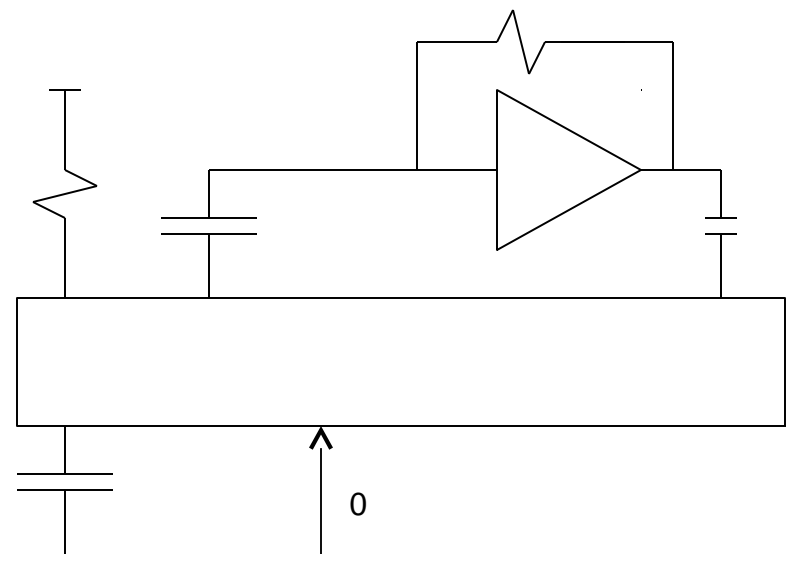

--



#

03

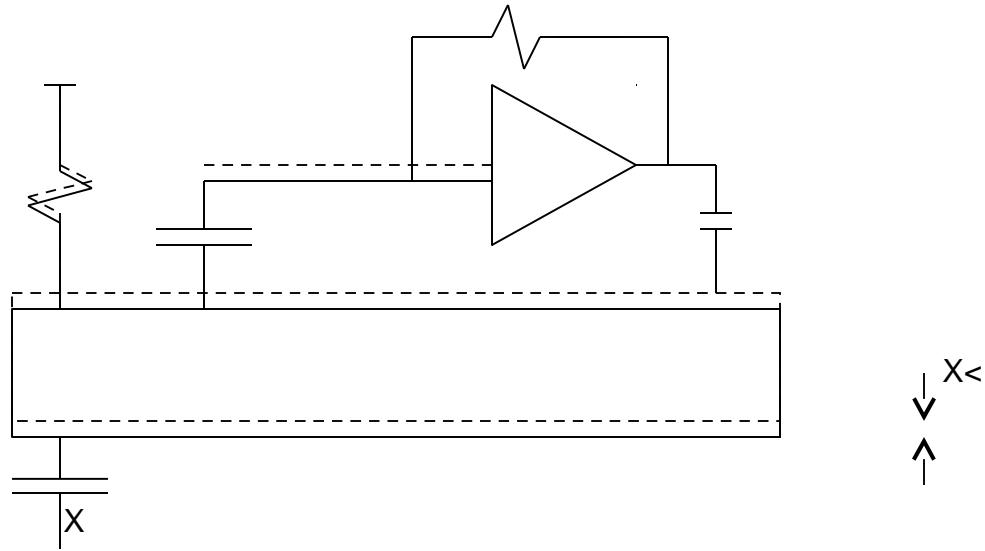

--

-



9"

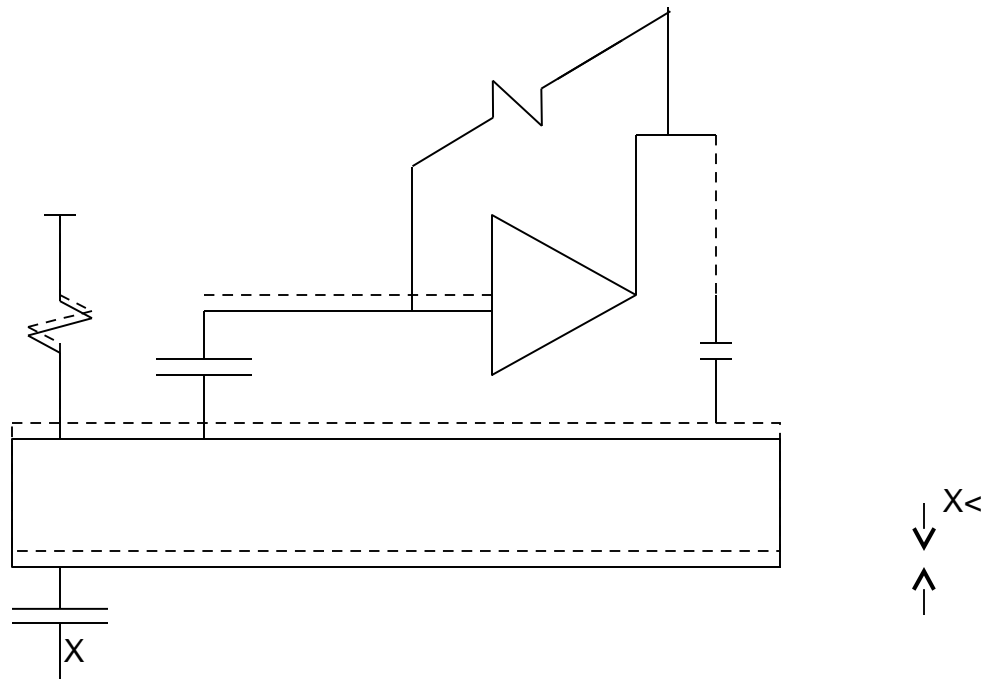

\downarrow $X <$
 \uparrow

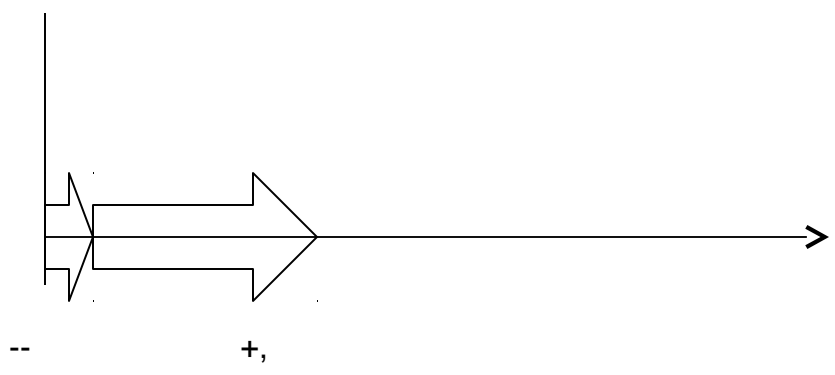



E 1
/03 *
\$ 0

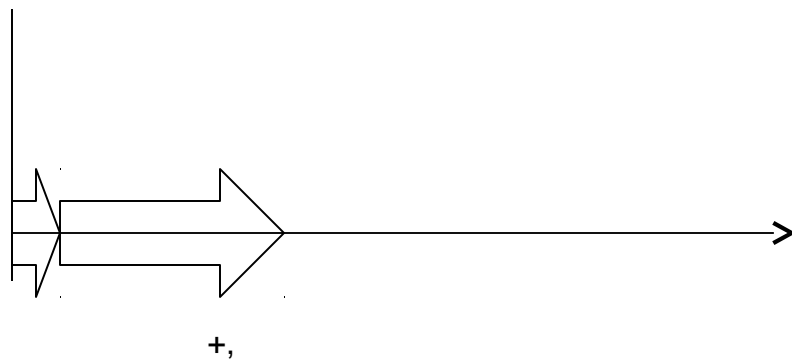
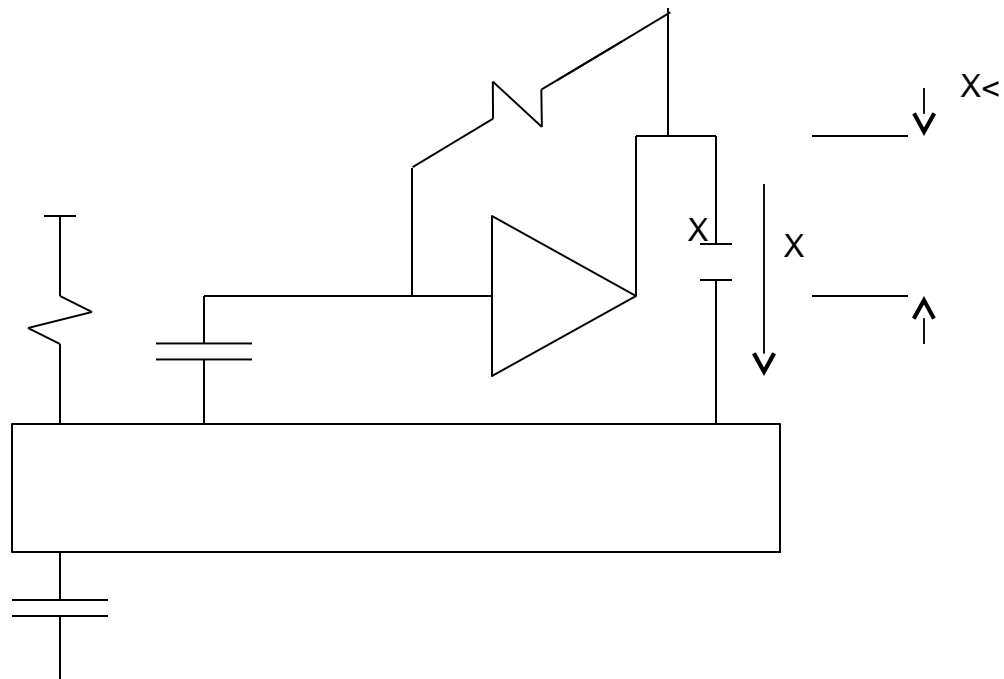

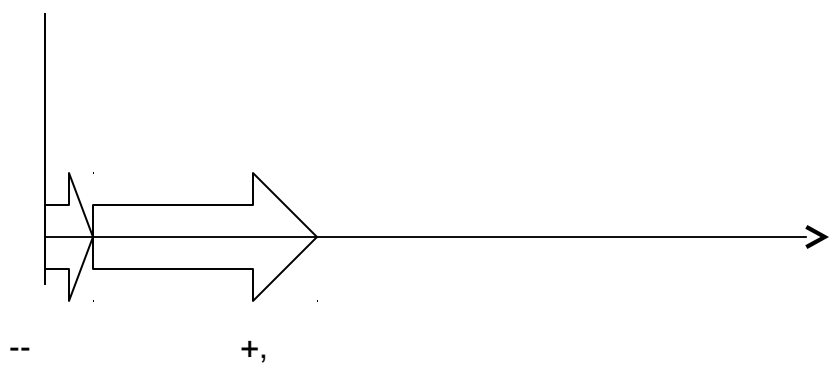
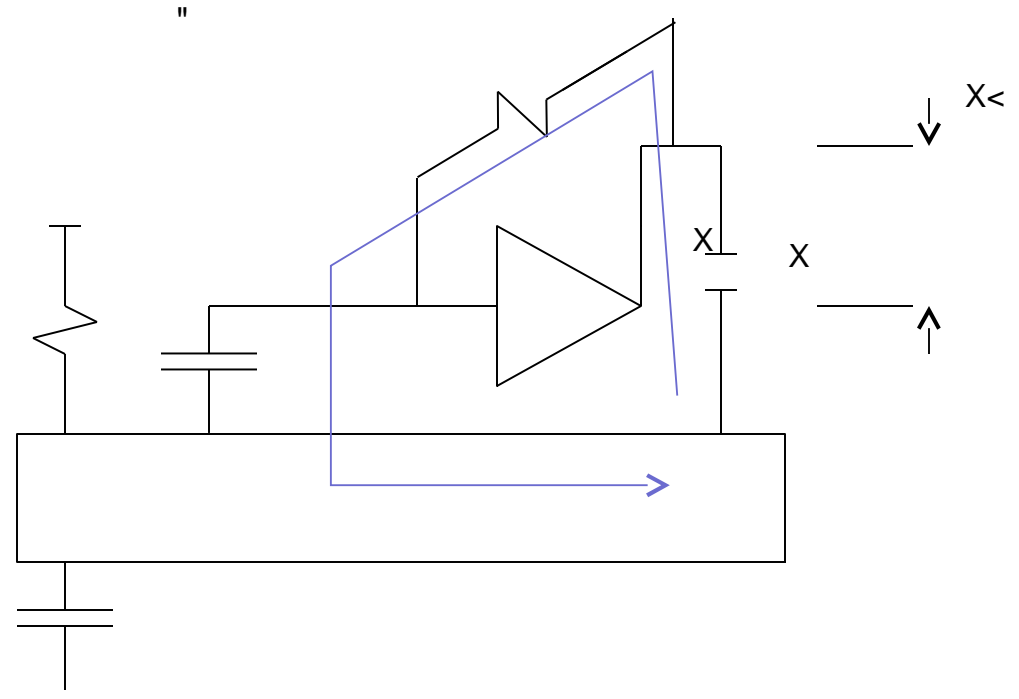



/03

Y

" " 4

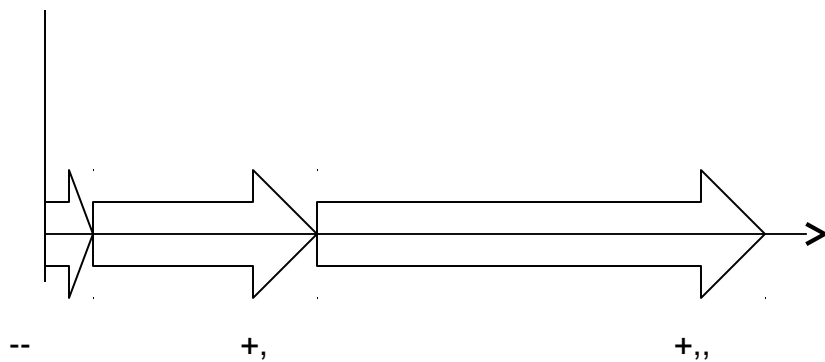
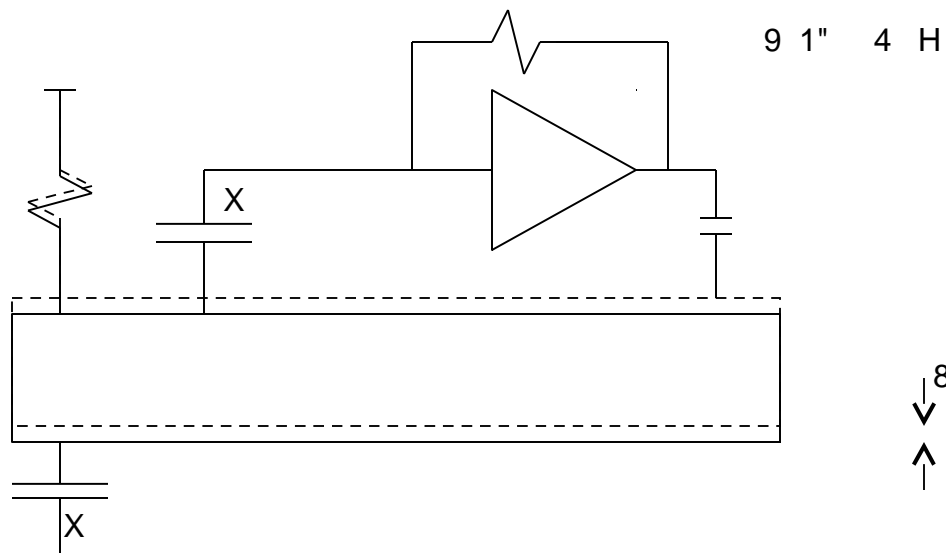



03

1

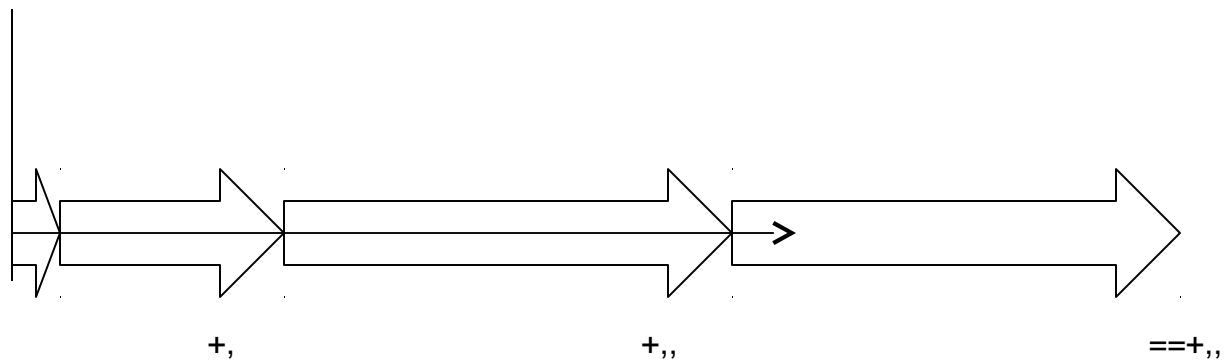
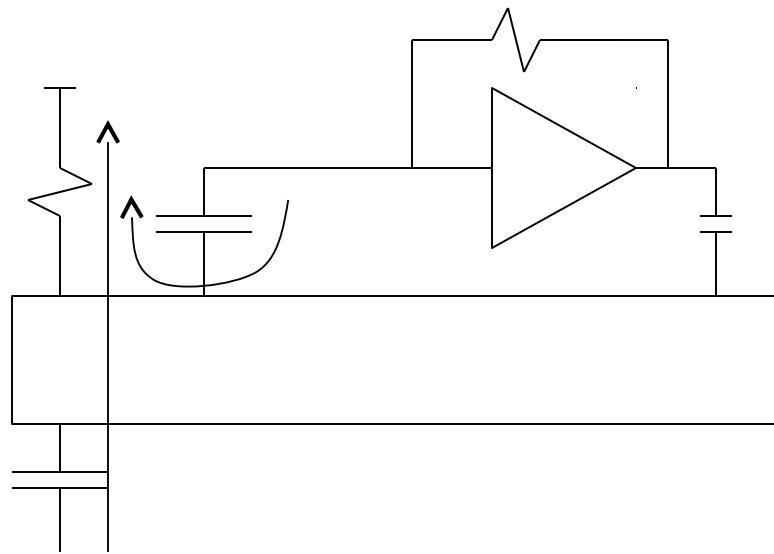



```

      1 4
53 " " "4 2 2
  1 " 1 3 1 " 0 "
" 1 " 3
% 1 (9$& ,@*+>" )
Q0 1 .,$ ( 0 1 7 1
   )7 1 0
  1 "

```



% 1 4

, + | < " (1 1) 7
7 \$ 7 1

3 Z

/ 1 , : | < " (1) 7 7
1

V 5 V 1

/ 1

\$ 1

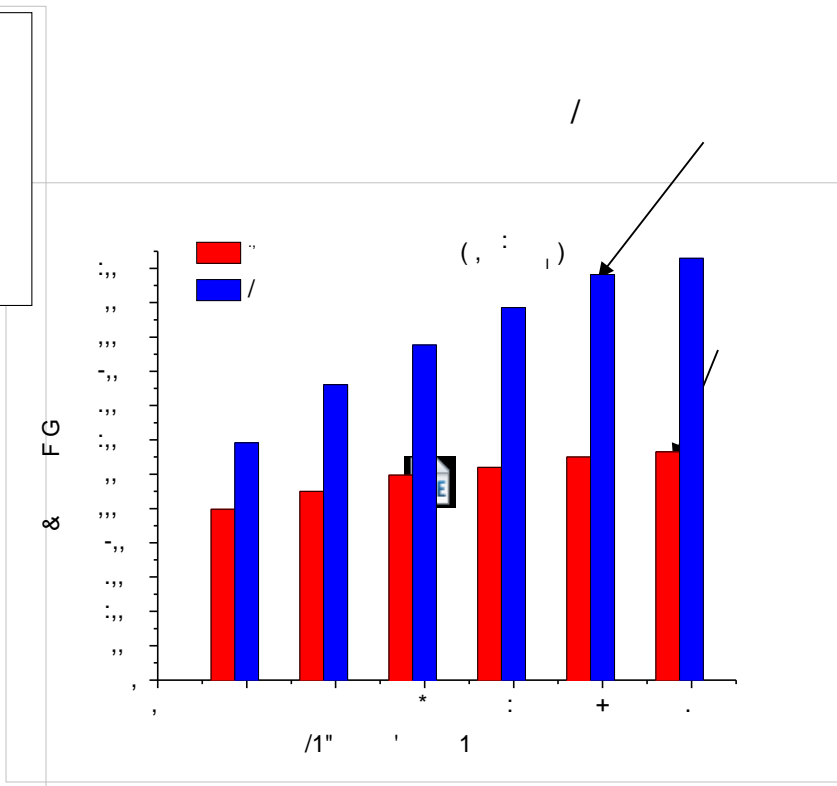
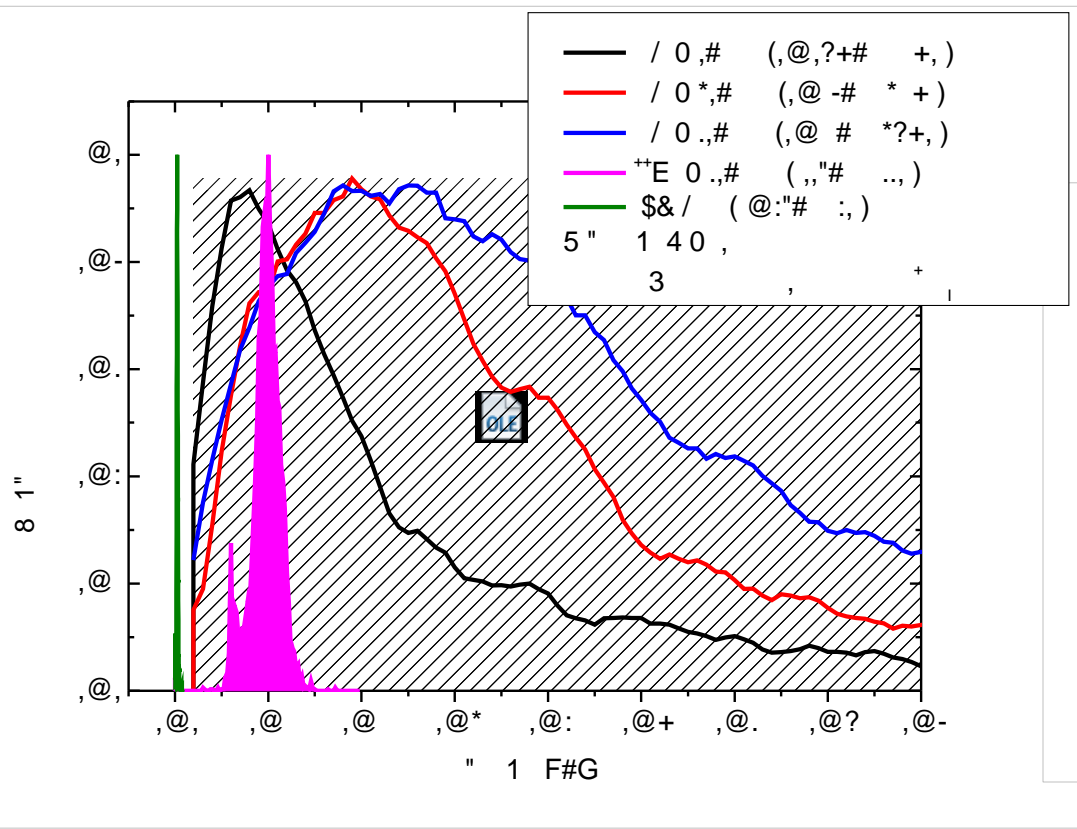

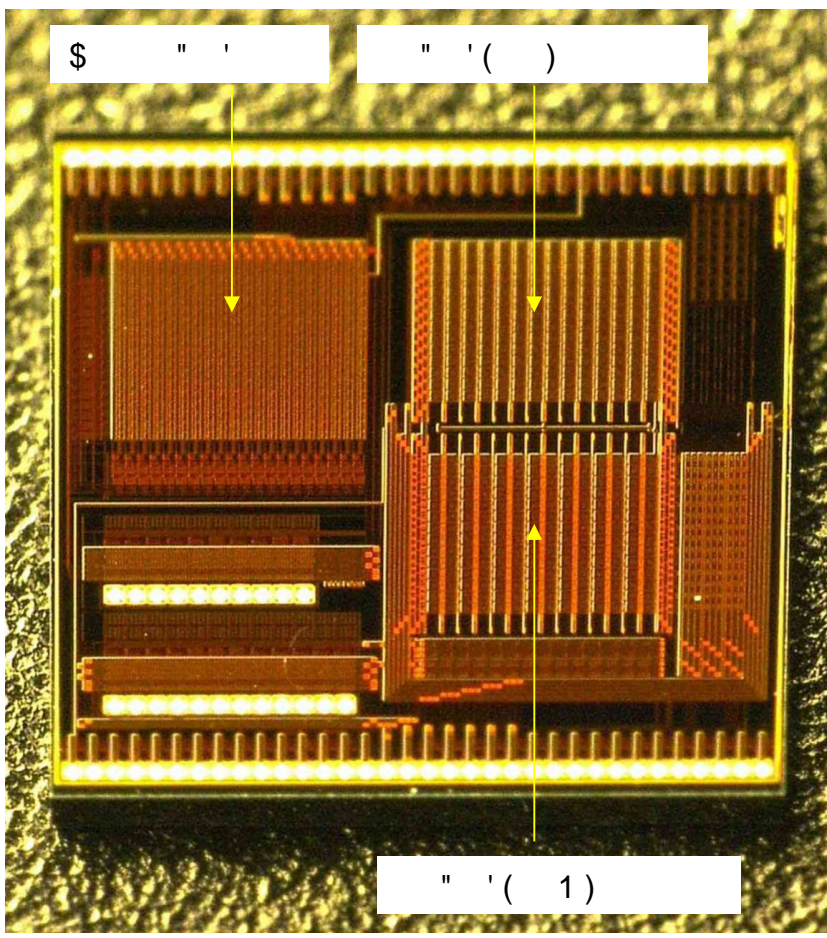

&
++'?, >" ' 2

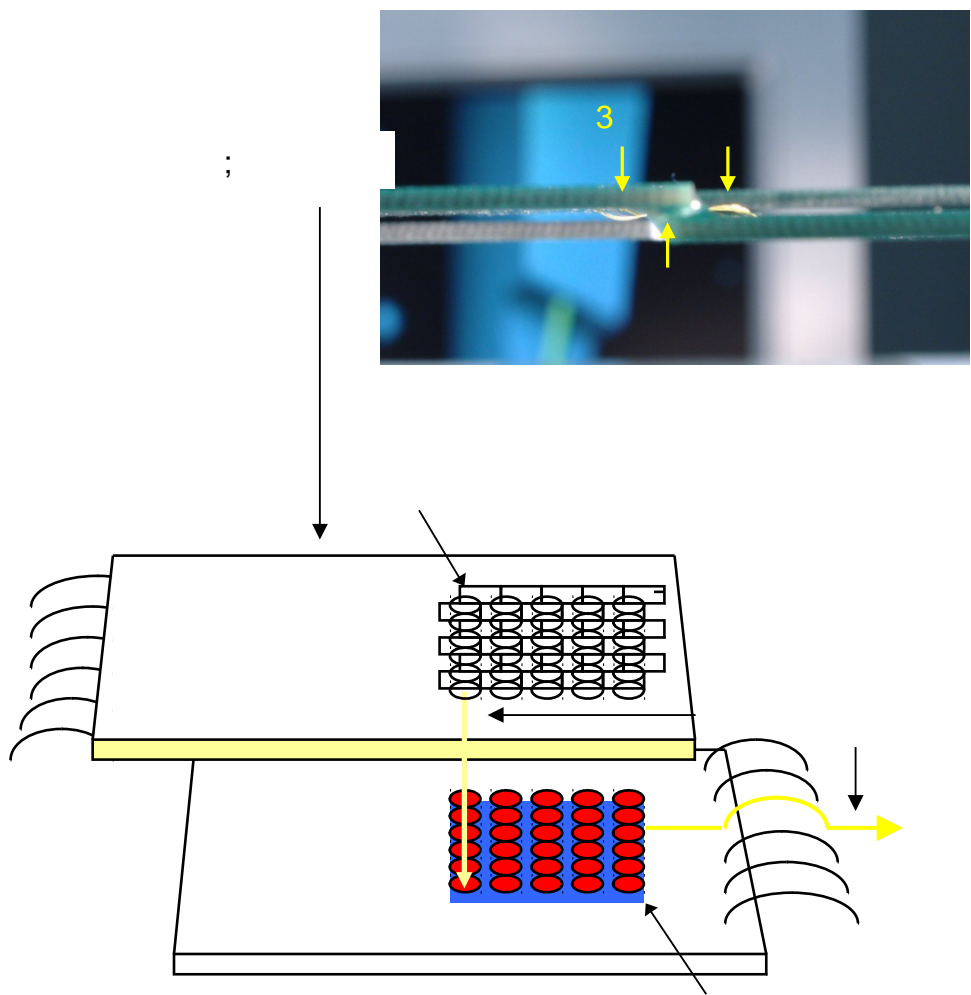

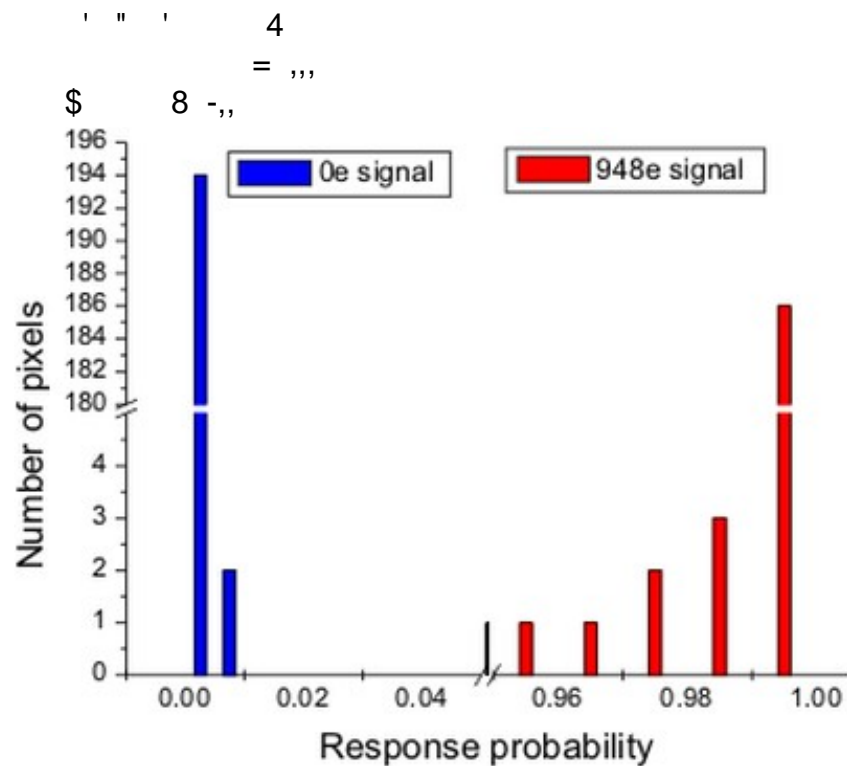
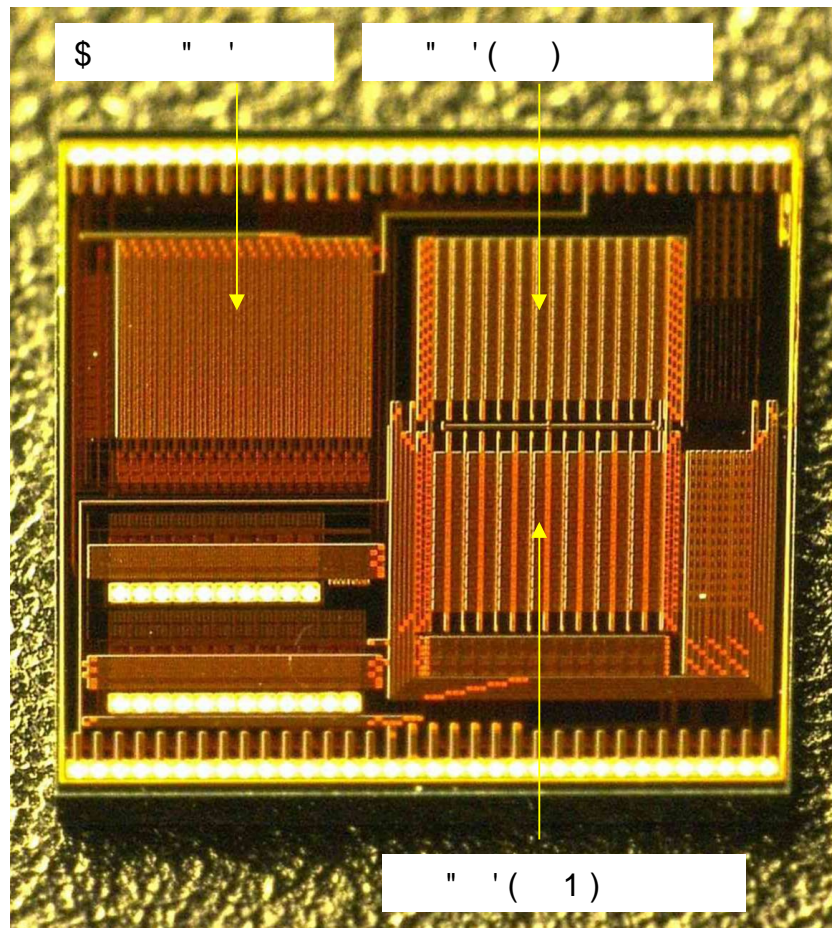

&
++'?, >" ' 2

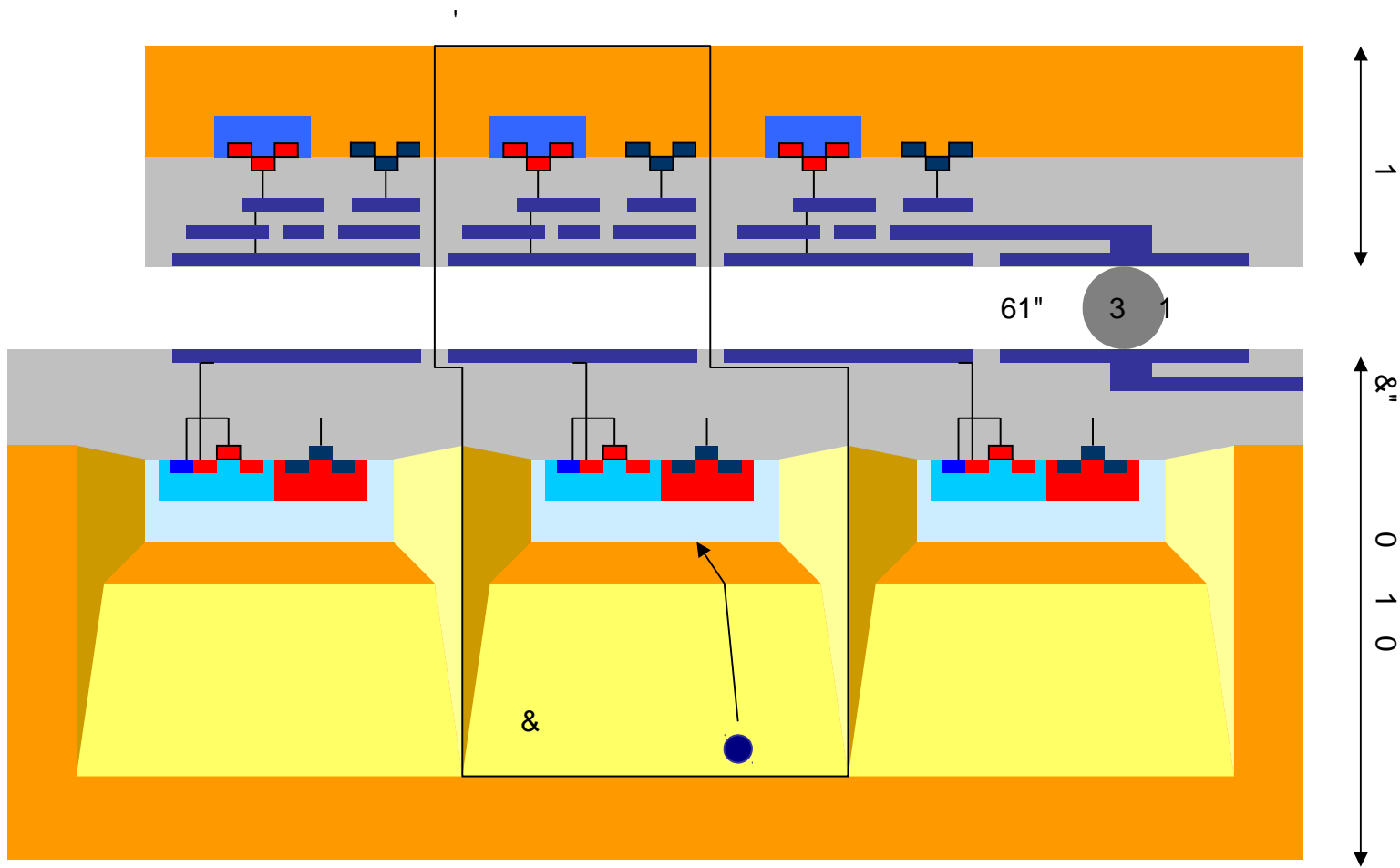

B*



522 ! E 1
 \$ \$@
 53 !
 E 1 *, " @
 53 3 ()
 3 10 1
 " 0 " @
 E 1 522 1 >"
 15 \$ C
 D @
 5 &1 (5&#) 2
 " 2 7 "
 (5&# " >" 5&#
 + >")@
 5 3
 1 @ 6 "
 @

