



Schweizerische Eidgenossenschaft
Confédération suisse
Confederazione Svizzera
Confederaziun svizra

Schlussbericht 17. August 2015

Electricity markets and trade in Switzerland and its neighbouring countries (ELECTRA)

Building a coupled techno-economic modeling framework

Auftraggeber:

Bundesamt für Energie BFE
Forschungsprogramm Energie – Wirtschaft – Gesellschaft (EWG)
CH-3003 Bern
www.bfe.admin.ch

Auftragnehmer:

Econability F. Vöhringer
Fischermatt 12
CH-3127 Mühlethurnen
www.econability.com

Paul Scherrer Institut
CH-5232 Villigen PSI
www.psi.ch

École Polytechnique Fédérale de Lausanne
Laboratory of Environmental and Urban Economics (LEURE)
Bât. BP
Station 16
CH-1015 Lausanne
leure.epfl.ch

Autoren:

Maire, Sophie, Ecole Polytechnique Fédérale de Lausanne (EPFL) & Econability
Pattupara, Rajesh, Paul Scherrer Institut (PSI)
Ramachandran, Kannan, Paul Scherrer Institut (PSI)
Vielle, Marc, Ecole Polytechnique Fédérale de Lausanne (EPFL)
Vöhringer, Frank (Projektleitung), Econability & EPFL, voehringer@econability.com

BFE-Projektbetreuer: Aurelio Fetz

BFE-Bereichs- und Programmleiterin: Anne-Kathrin Faust

BFE-Vertrags- und Projektnummer: SI/500632

Für den Inhalt und die Schlussfolgerungen sind ausschliesslich die Autoren dieses Berichts verantwortlich.

Executive Summary	9
Résumé.....	13
Zusammenfassung	17
1 Introduction	21
1.1 The ELECTRA research program.....	21
1.2 CROSSTEM	22
1.3 ELECTRA-CH	22
1.4 Scenarios	23
1.4.1 Domestic scenarios.....	23
1.4.2 International scenarios	24
1.5 Report structure	26
2 The three models	27
2.1 CROSSTEM	27
2.1.1 Background	27
2.1.2 Analytical framework	28
2.1.3 Model development	29
2.1.4 Model structure.....	29
2.1.4.1 <i>Regions</i>	29
2.1.4.2 <i>Time horizon</i>	30
2.1.4.3 <i>Time slices</i>	31
2.1.4.4 <i>Currency unit</i>	32
2.1.5 Reference Energy System (RES).....	32
2.1.6 Electricity end use sectors.....	33
2.1.7 Electricity generation technologies	35
2.1.7.1 <i>Existing technologies</i>	35
2.1.7.2 <i>Hydro power</i>	36
2.1.7.3 <i>Nuclear power</i>	37
2.1.7.4 <i>Thermal power</i>	38
2.1.7.5 <i>Renewables</i>	38
2.1.7.6 <i>New and future technologies</i>	40
2.1.8 Energy resources	42
2.1.9 Electricity trade	43

2.1.10	Carbon dioxide emissions	44
2.1.11	Application of the CROSSTEM model	44
2.1.11.1	<i>Scenario overview</i>	45
2.1.11.2	<i>Results</i>	47
2.1.11.2.1	<i>Electricity generation mix</i>	47
2.1.11.2.2	<i>Generation schedule</i>	50
2.1.11.2.3	<i>Electricity trade – source of import and market for export</i>	51
2.1.11.2.4	<i>Cost of electricity supply</i>	53
2.1.11.2.5	<i>CO₂ emissions</i>	55
2.1.12	Advantages of CROSSTEM over CROSSTEM-CH	55
2.1.12.1	<i>Electricity generation mix</i>	55
2.1.12.2	<i>Electricity generation schedule</i>	57
2.1.13	Model limitations and uncertainties	59
2.2	GENESWIS	60
2.2.1	Introduction	60
2.2.2	Model structure.....	60
2.2.2.1	<i>Production</i>	60
2.2.2.2	<i>Consumption</i>	63
2.2.2.3	<i>Government and taxes</i>	63
2.2.2.4	<i>Trade</i>	64
2.2.3	Electricity supply and demand	65
2.2.3.1	<i>Electro-mobility</i>	65
2.2.4	Baseline and dynamic calibration.....	67
2.2.4.1	<i>Steady state calibration</i>	67
2.2.4.2	<i>Baseline calibration and policies</i>	67
2.2.5	Data.....	70
2.2.5.1	<i>Input-output table disaggregation</i>	70
2.2.5.2	<i>Elasticities of substitution</i>	71
2.3	GEMINI-E3	73
2.3.1	Production.....	74
2.3.2	Consumption	74
2.3.3	Baseline calibration	75
2.3.4	International climate policy scenarios.....	75
2.3.4.1	<i>The Baseline scenario</i>	76
2.3.4.2	<i>The Moderate stringency scenario</i>	77

3	The coupled ELECTRA frameworks	80
3.1	ELECTRA-CH: Coupling CROSSTEM-CH and GENESwIS.....	80
3.1.1	Coupling methodology.....	80
3.1.1.1	Overview.....	80
3.1.1.2	Coupling structure	81
3.1.1.3	CROSSTEM-CH input into GENESwIS.....	82
3.1.1.3.1	Modifications of the GENESwIS model	82
3.1.1.3.2	Link CROSSTEM-CH's costs to GENESwIS' electricity generation and price	83
3.1.1.4	GENESwIS input into CROSSTEM-CH.....	86
3.1.1.4.1	Demand.....	86
3.1.1.4.2	Factor and input prices variation	86
3.1.1.5	Harmonization and convergence	87
3.1.1.5.1	Harmonization of the models	88
3.1.1.5.2	Supply elasticity	88
3.1.1.5.3	Dampening the demand response.....	89
3.1.1.5.4	Convergence criterion	91
3.1.2	Linking electricity prices and costs in bottom-up top-down coupling under changing market environments (working paper)	91
WP 1	Introduction	92
WP 2	Framework.....	93
WP 2.1	Models	94
WP 2.1.1	Bottom-up model: CROSSTEM-CH.....	94
WP 2.1.2	Top-down model: GENESwIS	94
WP 2.2	Coupling	94
WP 3	Scenarios.....	96
WP 4	Mechanisms at work	97
WP 4.1	Prices in the baseline scenarios.....	97
WP 4.2	The effects of an electricity tax.....	98
WP 4.3	The effect of demand changes on marginal and average generation costs.....	98
WP 4	Results.....	99
WP 5.1	Generation costs.....	99
WP 5.1.1	Marginal cost	99
WP 5.1.2	Average cost	99
WP 5.2	From costs to end user prices under alternative market regulation.....	99
WP 5.2.1	Liberalized market.....	99
WP 5.2.2	Regulated market	100

WP 6	Conclusions.....	101
3.1.3	Further results of the coupled framework.....	102
3.1.3.1	Reminder for the domestic scenarios	102
3.1.3.2	Electricity prices and demand	102
3.1.3.3	Electricity generation mix	103
3.1.3.4	Generation schedule.....	105
3.1.3.5	System cost and average electricity cost.....	108
3.1.3.6	Welfare and consumption	110
3.1.3.7	Sectoral effects.....	112
3.1.3.8	Foreign trade.....	113
3.1.3.9	CO₂ emissions	114
3.1.3.10	Comparing results from the coupled ELECTRA-CH framework with results from stand-alone models	117
3.1.3.10.1	Comparing coupled ELECTRA-CH results with CROSSTEM-CH results.....	117
3.1.3.10.2	Comparing coupled ELECTRA-CH results and GENESwIS results.....	118
3.2	ELECTRA: Coupling CROSSTEM, GENESwIS and GEMINI-E3	122
3.2.1	Motivation.....	122
3.2.2	Coupling methodology.....	124
3.2.3	State of the coupling.....	126
3.2.3.1	Completed tasks	126
3.2.3.2	Modifications of the GEMINI-E3 model	127
3.2.3.2.1	Dynamic calibration	128
3.2.3.2.2	Further modifications to enable the linking of GEMINI-E3 and CROSSTEM	129
3.2.3.2.3	GEMINI-E3 stand-alone versus GEMINI-E3 with energy mix coming from CROSSTEM.....	129
3.2.3.3	Trade related issues.....	131
3.2.4	Further research	132
4	Conclusions	133
	References	137
	Appendix A – Country specific details.....	144
1	Austria	144
1.1	Existing technologies	144
1.2	Hydro power	144
1.3	Solar PV	145

1.4	Wind.....	146
1.5	Electricity demand load curve	146
1.6	Electricity Import / Export	147
2	Germany	147
2.1	Existing technology.....	147
2.2	Solar PV	148
2.3	Wind.....	148
2.4	Electricity demand curves	149
2.5	Electricity import/export.....	150
3	France	150
3.1	Existing technology.....	150
3.2	Solar PV	151
3.3	Wind.....	151
3.4	Electricity demand curves	152
3.5	Electricity import/export.....	152
4	Italy	153
4.1	Existing technology.....	153
4.2	Solar PV	153
4.3	Wind.....	154
4.4	Electricity demand curves	155
4.5	Electricity import/export.....	155
5	Switzerland	156
5.1	Existing technologies	156
5.2	Hydro power	156
5.3	Solar PV	157

5.4	Wind.....	158
5.5	Load curve.....	158
5.6	Electricity import / export.....	159
5.7	Net electricity import restrictions for the NoGas scenario	159
Appendix B – CROSSTEM results		160
1	Country-specific results.....	160
1.1	France	160
1.2	Germany	161
1.3	Italy	163
1.4	Austria	164
2	Generation Schedules.....	166
2.1	Scenario 1	166
2.2	Scenario 2.....	168
2.3	Scenario 3.....	169
Appendix C – CROSSTEM-CH results in the coupled ELECTRA-CH framework.....		171
1	Generation schedule – comparison between three scenarios.....	171

Executive Summary

Objective

The research project *Electricity markets and trade in Switzerland and its neighbouring countries* (ELECTRA) ran from July 2011 to January 2015. Its main goal was to create coupled modeling frameworks for energy policy analysis in Switzerland which can be employed to answer research questions such as

- How do EU climate and energy policies with implications for the European electricity mix affect Switzerland?
- How do global climate policy and fossil fuel scenarios affect substitution between energy carriers and especially electricity demand in Switzerland?
- What are the effects of political decisions which influence technology choices in electricity generation on the rest of the Swiss economy?
- How do long-term electricity pricing and sectoral profits depend on cost structure and technology mix?
- Given the advanced stage of integration of the European electricity market, does the view on Swiss energy dependence in electricity supply change when we endogenously model imports and exports on an hourly basis?

More generally, **the objective was to include international and multisectoral feedbacks as well as general equilibrium effects in the modeling of electricity markets in order to improve model-based energy policy analysis in Switzerland.**

The new modeling frameworks

During this project, we finalized two major model developments:

- **The technology-rich multiregional Cross Border TIMES Electricity Model (CROSSTEM), of five countries (Austria, France, Germany, Italy and Switzerland),** which uses the TIMES cost optimization framework. The model minimizes the cost of supply of electricity for an exogenously given electricity demand. It covers long time horizons and hourly intra-annual temporal resolution to account for variability in electricity supply and demand. Electricity trade between Switzerland and its four neighbouring countries is endogenous based on marginal costs of supply, subject to technical and environmental constraints. Hence, CROSSTEM generates insights on transition pathways for the Swiss electricity system by taking into account developments in the neighbouring countries.
- **The coupled framework ELECTRA-CH, which consists of the Swiss region of the CROSSTEM model (CROSSTEM-CH) and of the dynamic computable general equilibrium (CGE) model for the Swiss economy GENESwIS.** ELECTRA-CH integrates a multisectoral general equilibrium representation of the Swiss economy with a detailed technology-based modeling of electricity supply. In the coupled framework, the representation of electricity supply from the CROSSTEM-CH model is prioritized over that of the GENESwIS model. The endogenous demand variations of the GENESwIS model are then prioritized over the fixed demand

assumptions of the CROSSTEM-CH model. Moreover, sectoral prices feedback from the GENESwIS model is used to modify capital and operational costs of technologies in CROSSTEM-CH. ELECTRA-CH is designed to analyze the Swiss electricity market under environmental and energy policies, and its link to the Swiss economy.

We have also undertaken major steps towards linking CROSSTEM with GEMINI-E3, which is a multi-regional CGE model of the global economy, in order to create the coupled ELECTRA framework consisting of CROSSTEM, GEMINI-E3 and GENESwIS. The goal of this coupling is to enable an even more integrated analysis, especially concerning the impact of global and EU climate and energy policies on Switzerland.

Scenarios

The scenarios analyzed for this report have been designed to test and illustrate the functioning of the model frameworks. Three domestic scenarios deserve to be highlighted: A baseline scenario, a market instrument scenario (*TAX*), and a scenario putting forward technological restrictions with the prohibition of gas power plants (*NoGAS*). **These scenarios were chosen to illustrate one of the central advantages of coupled bottom-up top-down frameworks: They are suitable for analyzing the effects of both market instruments and technology-oriented restrictions and policies.**

Coupling lessons learned

Much of the progress made has been on methodological issues which arise when different types of models should be robustly coupled with the best consistency achievable. The experience of the design, implementation and testing of the ELECTRA-CH framework provided the following insights:

- A **careful harmonization** of the models is crucial for framework convergence and for producing dependable results.
- Bottom-up and top-down models are based on different methodologies and different logics. **The variables to be linked must be meticulously selected and interpreted**, not to introduce inaccuracies or logic flaws in the framework.
- **Demand dampening** (Gauss-Seidel) is an essential approach for achieving convergence.
- **Assumptions on the future evolution of electricity market regulation change the interpretation of variables during coupling and thus have an impact on the results.**

In addition, the effort on coupling CROSSTEM and GEMINI-E3 unfolded methodological issues due to the different treatment of trade, both regarding each model's definitions of import and export prices and the diverging optimization approaches that determine endogenous trade decisions: GEMINI-E3 has one representative household per region, each of which optimizes its utility, while CROSSTEM minimizes total electricity system cost for the five countries, which implies that the solution is not necessarily optimal for each of the five countries.

Energy economic lessons learned

The simulations with the two existing new frameworks confirm the importance of including all relevant effects in model-based energy policy analysis. When we adequately integrate technological, intersectoral, international, and general equilibrium feedbacks, the economic effects of policies differ not just slightly, but fundamentally, at least for some scenarios. This conclusion can

safely be drawn even on the basis of the few scenarios that we have already simulated, because we see the large impacts that structural model changes can have on the results. The direction and magnitude of these differences is hard to predict before the simulations are performed, which is evidence for the need to use models that are sufficiently complex. When the investigated issue is complex, the model needs to incorporate this complexity, if it is not to lead to wrong conclusions. Then, the well-known challenge is to ensure that the more complex models still produce dependable results and that the individual effects remain traceable.

In the simulations with the coupled ELECTRA-CH framework, we witnessed how technology-based cost functions introduced profits into the zero-profit world of the CGE model GENESwIS and thus significantly altered equilibrium prices and demands as well as economic welfare. For example, the demand reduction that is prompted by an electricity tax is much more pronounced in ELECTRA-CH than in a stand-alone version of GENESwIS, which also has wider economic consequences in the model. This result is directly related to the technological options in the Swiss electricity system for the particular scenario and not transferable to other scenarios. This singularity only **confirms that it is important to explicitly simulate the technological options to be able to understand the working of market instruments in energy policy**. On the other hand, a pure supply-side bottom-up approach would clearly not be suitable for studying market instruments, because the demand-side would be missing.

Another striking example of the importance of technology rich cost modeling is the welfare improvement that results in ELECTRA-CH from a prohibition of natural gas when net electricity imports are allowed – which at the most correspond to the energy content of the gas that had previously been imported (*NoGAS* scenario). The favorable outcome of the scenario challenges narrow interpretations of supply security. Interestingly, the reduction in total system cost in the *NoGAS* scenario translates into a welfare gain of roughly only half the size, which highlights the importance of modeling the interaction of electricity supply with other sectors of the economy. The diminished welfare gain is attributable to a combination of microeconomic and general equilibrium effects which are explained in 3.1.3.6.

The policy-relevant effects that we have sketched here cannot be investigated with either stand-alone model, because CROSSTEM-CH operates with fixed demands and does not consistently translate costs into prices, while GENESwIS's cost functions do not adequately capture the differences between average and marginal costs of electricity supply. Thus, **it takes a coupled framework to analyze electricity markets adequately. Even more, the innovative feature of coupling with marginal cost pricing in competitive markets is indispensable** for producing the insights provided by the ELECTRA-CH framework. The usual procedure to couple top-down prices to bottom-up average costs may be simpler to implement and convenient for model convergence, but it is inconsistent with the microeconomic theory for competitive markets, and it neglects the formation of profits due to differences between average and marginal costs. As a result, it miscalculates both the impacts on the rest of the economy and the implications for electricity producers.

For the long-term electricity supply mix, the results in this report reveal many significant feedbacks from the rest of the economy as well as from developments abroad. **International electricity trade that is endogenously based on marginal costs, as realized in CROSSTEM, has shown to be especially influential for the results**. The representation of the neighbouring countries in CROSSTEM does not only determine the lowest-cost electricity supply configuration. Its hourly time resolution enables

CROSSTEM to account for the temporal variations in supply and demand, which is critical for evaluating the long term deployment of intermittent renewables.

Further research

The coupling of CROSSTEM, GEMINI-E3 and GENESwIS remains a worthwhile task, mostly to further improve the representation of international influences on the Swiss electricity sector. Next to this, more scenarios should be explored in the future to further test and elaborate the existing modeling frameworks. This would enable the frameworks to unfold their full potential to generate better-informed answers when investigating the influence of Swiss and foreign energy policies on the electricity supply mix, electricity prices, and economic welfare, just to name a few. Future simulations with these frameworks can also contribute to a better understanding of the long-term role of Swiss electricity producers in the European electricity system and the implications of this role for policy-makers and consumers. Based on the lessons from additional scenario runs, the two existing modeling frameworks CROSSTEM and ELECTRA-CH can be further enhanced.

Résumé

Objectifs

Le projet de recherche *Marchés et commerce de l'électricité en Suisse et dans les pays voisins* (ELECTRA) a été mené de juillet 2011 à janvier 2015. Son but principal a été de créer des structures de modélisation couplées pour l'analyse de politiques énergétiques en Suisse qui puisse être employé pour répondre à des questions comme:

- Comment des politiques climatiques et énergétiques de l'UE ayant des implications pour la production d'électricité européenne affectent la Suisse?
- Comment des scénarios de politique climatique mondiale et de développement des énergies fossiles vont-ils affecter la substitution de vecteurs énergétiques et en particulier la demande d'électricité en Suisse?
- Quels sont les effets pour le reste de l'économie suisse des décisions politiques qui influencent les choix technologiques concernant la production d'électricité?
- Comment la tarification de l'électricité et les profits sectoriels dépendent-ils à long terme de la structure des coûts et du mix technologique?
- Compte tenu de l'intégration avancée du marché européen de l'électricité, l'analyse de la dépendance énergétique suisse dans l'offre d'électricité change-t-elle quand on utilise une modélisation endogène des importations et des exportations sur une base horaire?

Plus généralement, **l'objectif a été d'inclure des effets de retour internationaux et multisectoriels ainsi que des effets d'équilibre général dans la modélisation des marchés de l'électricité, afin d'améliorer l'analyse de politiques énergétiques basée sur des modèles en Suisse.**

Les nouvelles structures de modélisation

Au cours de ce projet, nous avons finalisé deux importants développements de modèles:

- **Le modèle électrique multirégional, riche en technologies et transfrontalier *TIMES Electricity Model (CROSSTEM)* pour cinq pays (Autriche, France, Allemagne, Italie et Suisse)**, un modèle qui repose sur la structure d'optimisation des coûts *TIMES*. Le modèle minimise le coût de la fourniture d'électricité pour une demande d'électricité exogène donnée. Il couvre des horizons de temps longs et une résolution temporelle intra-annuelle horaire pour prendre en compte la variabilité de l'offre et la demande d'électricité. Les échanges d'électricité entre la Suisse et ses quatre voisins est endogène, basée sur les coûts de production marginaux sous contraintes techniques et environnementales. Par conséquent, *CROSSTEM* informe sur des sentiers de transition pour le système électrique suisse, en tenant compte des évolutions dans les pays voisins.
- **La structure couplée *ELECTRA-CH*, qui se compose de la région suisse du modèle *CROSSTEM (CROSSTEM-CH)* et du modèle dynamique d'équilibre général calculable (*EGC*) de l'économie suisse *GENESwIS*.** *ELECTRA-CH* intègre une représentation multisectorielle en équilibre général de l'économie suisse avec un modèle détaillé de l'approvisionnement électrique basé sur les technologies. Dans cette structure couplée, la représentation de la

fourniture d'électricité à partir du modèle CROSSTEM-CH est prioritaire par rapport à celle du modèle GENESWIS. Les variations endogènes de la demande d'électricité du modèle GENESWIS priment à leur tour sur les hypothèses de la demande fixe du modèle CROSSTEM-CH. En outre, l'ajustement des prix sectoriels calculé par le modèle GENESWIS est renvoyé dans le modèle CROSSTEM-CH pour y modifier les coûts fixes et variables des technologies. ELECTRA-CH est conçu pour analyser le marché suisse de l'électricité soumis à des politiques de l'énergie et de l'environnement, ainsi que ses liens avec l'économie Suisse.

Nous avons également entrepris des mesures importantes en vue de relier CROSSTEM avec GEMINI-E3, un modèle EGC multi-régions de l'économie mondiale, afin de créer la structure couplée ELECTRA composée de CROSSTEM, GEMINI-E3 et GENESWIS. Le but de ce grand couplage est de permettre une analyse encore plus intégrée, en particulier concernant l'impact des politiques climatiques et énergétiques mondiales et de l'UE sur la Suisse

Scenarios

Les scénarios analysés pour ce rapport ont été conçus pour tester et illustrer le fonctionnement des structures de modélisation. Trois scénarios nationaux méritent d'être soulignés: un scénario de base, un scénario d'instrument de marché (*TAX*), et un scénario mettant en avant les restrictions technologiques avec l'interdiction des centrales à gaz (*NoGAS*). **Ces scénarios ont été choisis pour illustrer l'un des avantages centraux de structures couplées *bottom-up/top-down*: Ils sont adaptés pour analyser les effets à la fois des instruments de marché et des restrictions et politiques axées sur les technologies.**

Leçons apprises par le couplage

Une grande partie des progrès réalisés ont porté sur les questions méthodologiques qui se posent lorsque différents types de modèles devraient être solidement couplés dans la meilleure cohérence possible. L'expérience de la conception, la mise en œuvre et les tests de la structure ELECTRA-CH a livré les leçons suivantes:

- Une **harmonisation soignée** des modèles est cruciale pour la convergence de la structure d'analyse et pour la production de résultats fiables.
- Les modèles *bottom-up* et *top-down* sont basés sur des méthodologies et logiques différentes. **Les variables à relier doivent être soigneusement sélectionnées et interprétées** pour éviter d'introduire des inexactitudes ou des défauts de logique dans la structure d'analyse.
- **L'atténuation des fluctuations de la demande** (Gauss-Seidel) est essentielle pour obtenir la convergence.
- **Les hypothèses sur l'évolution future de la réglementation du marché de l'électricité modifient l'interprétation des variables lors du couplage et ont donc un impact sur les résultats.**

En outre, l'effort de couplage de CROSSTEM et GEMINI-E3 a révélé des enjeux méthodologiques dus aux différences dans le traitement des échanges commerciaux, à la fois en ce qui concerne la définition des prix à l'importation et à l'exportation dans chaque modèle et les approches

d'optimisation divergentes utilisées pour déterminer les décisions d'échange endogènes: GEMINI -E3 utilise un ménage représentatif par région qui maximise son bien-être, alors que CROSSTEM minimise le coût total du système électrique pour les cinq pays, ce qui implique que la solution n'est pas nécessairement optimale pour chacun des cinq pays.

Leçons apprises pour l'économie de l'énergie

Les simulations avec les deux nouvelles structures de modélisation confirment l'importance d'inclure tous les effets pertinents dans l'analyse de politiques énergétiques basée sur des modèles. Lorsque nous intégrons de manière adéquate les effets de retour technologiques, intersectoriels, internationaux et d'équilibre général, les effets économiques des politiques ne diffèrent pas juste un peu, mais fondamentalement, au moins pour certains scénarios. Cette conclusion peut être tirée en toute sécurité même sur la base des quelques scénarios que nous avons déjà simulés, parce que nous voyons les grands impacts que les changements structurels des modèles peuvent avoir sur les résultats. La direction et l'amplitude de ces différences est difficile à prévoir avant d'effectuer les simulations, ce qui démontre la nécessité d'utiliser des modèles suffisamment complexes. Lorsque la question examinée est complexe, le modèle doit intégrer cette complexité, sinon il conduit à des conclusions erronées. Ensuite, le défi bien connu est d'assurer que les modèles plus sophistiqués continuent de produire des résultats fiables et que les effets individuels restent traçables.

Dans les simulations avec la structure couplée ELECTRA-CH, nous avons découvert comment les fonctions de coût reposant sur les technologies font apparaître des profits dans le monde à profits nuls (concurrence parfaite) du modèle EGC GENESWIS et donc modifient de manière significative les prix et consommation à l'équilibre ainsi que le bien-être économique. Ainsi par exemple, la réduction de la demande provoquée par une taxe sur l'électricité est beaucoup plus prononcée dans ELECTRA-CH que dans une version autonome de GENESWIS, ce qui a également des conséquences économiques plus larges dans le modèle. Ce résultat est directement lié aux options technologiques dans le système électrique suisse pour ce scénario spécifique; il ne se laisse pas généraliser pour d'autres scénarios. Cette singularité ne fait que **confirmer qu'il est important de simuler explicitement les options technologiques pour être en mesure de comprendre le fonctionnement des instruments de marché dans la politique énergétique.** D'autre part, une approche purement *bottom-up* de l'offre ne serait clairement pas adaptée à l'étude des instruments du marché, puisqu'il manquerait le côté de la demande.

Un autre exemple flagrant de l'importance d'un modèle doté d'une représentation des coûts riche en technologies est l'amélioration du bien-être obtenue avec ELECTRA-CH lorsque les importations nettes d'électricité sont autorisées mais pas le gaz naturel, importations qui correspondent au maximum à la teneur énergétique du gaz qui avait été importé précédemment (scénario *NoGAS*)

L'issue favorable du scénario défie les étroites interprétations de la sécurité d'approvisionnement. Fait intéressant, la baisse du coût total du système dans le scénario *NoGAS* se traduit en gain de bien-être divisé plus ou moins par deux, ce qui met en évidence l'importance de la modélisation de l'interaction entre l'approvisionnement en électricité et les autres secteurs de l'économie. Cette baisse du gain en bien-être est attribuable à une combinaison d'effets microéconomiques et d'équilibre général expliqués dans le paragraphe 3.1.3.6.

Ces effets pertinents pour les politiques publiques que nous avons esquissés ici ne peuvent pas être étudiés de façon autonome par l'un des modèles utilisés. En effet, CROSSTEM-CH fonctionne avec des demandes fixes et ne traduit pas de façon cohérente les coûts dans les prix, alors que les fonctions de coût de GENESwis ne reflètent pas de manière adéquate les différences entre les coûts moyens et marginaux de l'approvisionnement électrique. Ainsi, **il faut une structure couplée pour analyser de façon adéquate le marché de l'électricité. Plus encore, la caractéristique innovante du couplage avec tarification au coût marginal dans les marchés concurrentiels est indispensable** pour obtenir leçons apprises avec la structure ELECTRA-CH. L'approche usuelle pour coupler les prix *top-down* aux coûts moyens *bottom-up* peut être plus simple à mettre en œuvre et plus commode pour faire converger les modèles, mais elle est incompatible avec la théorie microéconomique des marchés concurrentiels et néglige la formation de bénéfices en raison des différences entre coûts moyens et marginaux. En conséquence, cette approche calcule mal à la fois les impacts sur le reste de l'économie et les implications pour les producteurs d'électricité.

Pour le mix d'approvisionnement électrique à long terme, les résultats de rapport révèlent de nombreux effets de retour provenant aussi bien du reste de l'économie que de développements à l'étranger. **Le commerce international d'électricité qui repose de façon endogène sur les coûts marginaux, comme modélisé dans CROSSTEM, a démontré son influence particulière sur les résultats.** La représentation des pays voisins dans CROSSTEM ne détermine pas seulement la configuration d'approvisionnement électrique la moins coûteuse. Sa résolution temporelle horaire permet à CROSSTEM de tenir compte des fluctuations de l'offre et de la demande, ce qui est crucial pour évaluer le déploiement à long terme des énergies renouvelables intermittentes.

Recherches à venir

Continuer de travailler sur le couplage de CROSSTEM, GEMINI-E3 et GENESWIS reste une tâche digne d'intérêt, en particulier pour améliorer encore la représentation des influences internationales sur le secteur de l'électricité suisse. A côté de ceci, plus de scénarios devraient être explorés dans le futur pour continuer de tester et améliorer les structures de modélisation existantes. Cela permettrait à ces structures de déployer tout leur potentiel pour générer des réponses mieux informées lorsqu'on examine l'influence de politiques énergétiques suisses et étrangères sur le mix d'approvisionnement électrique, les prix de l'électricité et le bien-être économique, pour ne citer que ceux-ci. Des simulations futures avec ces structures peuvent aussi contribuer à une meilleure compréhension du rôle à long terme des producteurs suisses d'électricité dans le système électrique européen et des implications de ce rôle pour les autorités et les consommateurs. Les simulations de scénarios additionnels montrent que les deux structures de modélisation CROSSTEM et ELECTRA-CH peuvent encore être enrichies.

Zusammenfassung

Projektziel

Das Forschungsprojekt *Electricity markets and trade in Switzerland and its neighbouring countries* (ELECTRA) lief von Juli 2011 bis Februar 2015. Sein Hauptziel war es, gekoppelte Computermodelle für die Analyse der Energiepolitik in der Schweiz zu erstellen. Forschungsfragen, die mit diesen Modellen beantwortet werden können, sind z.B.:

- Wie beeinflusst die EU-Klima- und Energiepolitik die Situation in der Schweiz z.B. mittels ihrer Auswirkungen auf den europäischen Strommix?
- Welchen Einfluss haben verschiedene Szenarien zur internationalen Klimapolitik und zu fossilen Brennstoffvorkommen auf die Substitution zwischen Energieträgern und vor allem auf die Schweizer Stromnachfrage?
- Wie wirken sich politische Entscheidungen, die die Technologiewahl bei der Stromerzeugung beeinflussen, auf den Rest der Schweizer Wirtschaft aus?
- Wie beeinflusst der Technologiemix die Kostenstruktur, die langfristige Strompreisgestaltung und die Gewinne der Stromwirtschaft?
- Wie ändert sich der Blick auf die Schweizer Energieabhängigkeit in der Stromversorgung angesichts der fortgeschrittenen Integration des europäischen Strommarkts, wenn endogen modellierte Ein- und Ausfuhren auf Stundenbasis einbezogen werden?

Allgemeiner gesagt, war es das **Ziel, internationale und sektorübergreifende Rückwirkungen sowie allgemeine Gleichgewichtseffekte in der Modellierung von Strommärkten zu berücksichtigen, um die modellbasierte Analyse der Energiepolitik in der Schweiz zu verbessern.**

Die neuen Modelle

Im Rahmen dieses Projektes konnten zwei große Modellentwicklungen abgeschlossen werden:

- **Das technologiedetailreiche multiregionale CROSS Border TIMES Electricity Model (CROSSTEM), das fünf Länder umfasst (Schweiz, Österreich, Frankreich, Deutschland, Italien)** und auf dem TIMES Kostenoptimierungsmodell aufbaut. Es minimiert die Kosten der Elektrizitätsbereitstellung für eine exogen vorgegebene Stromnachfrage. Der Zeithorizont ist langfristig, bei stündlicher Auflösung der Stromnachfrage innerhalb eines Jahres, um die Veränderlichkeit von Stromangebot und -nachfrage zu berücksichtigen. Der Stromhandel zwischen der Schweiz und ihren vier Nachbarländern ist endogen, basierend auf den Grenzkosten des Angebots, unter Berücksichtigung technischer und ökologischer Restriktionen. CROSSTEM ermöglicht so ein besseres Verständnis von Entwicklungspfaden für die Schweizer Stromwirtschaft unter Berücksichtigung der Entwicklungen in den Nachbarländern.
- **Das gekoppelte Modell ELECTRA-CH, das aus der Schweizer Region des CROSSTEM Modells (CROSSTEM-CH) und dem dynamischen allgemeinen Gleichgewichtsmodell für die Schweiz (GENESWIS) besteht.** ELECTRA-CH vereint die Abbildung eines multisektoralen allgemeinen Gleichgewichts mit einer detaillierten technologiebasierten Darstellung der Stromversorgung. Im gekoppelten Gesamtmodell wird, was das Stromangebot betrifft, die

detaillierte Modellierung von CROSSTEM-CH gegenüber GENESwIS priorisiert. Die endogenen Nachfrageänderungen aus GENESwIS werden dagegen den exogenen Stromnachfragen des CROSSTEM-CH-Modells vorgezogen. Darüber hinaus werden sektorale Preisveränderungen aus GENESwIS zur Korrektur von Investitions- und Betriebskosten in CROSSTEM-CH verwendet. ELECTRA-CH wurde entwickelt, um den Schweizer Strommarkt sowie dessen Verknüpfung mit dem Rest der Schweizer Volkswirtschaft unter dem Einfluss verschiedener umwelt- und energiepolitischer Massnahmen zu analysieren.

Über diese beiden Modelle hinaus haben wir wesentliche Schritte im Hinblick auf eine Verknüpfung von CROSSTEM mit GEMINI-E3, einem multiregionalem Welthandelsmodell vom Typ des allgemeinen Gleichgewichts, erreicht, mit dem Ziel ein gekoppeltes ELECTRA-Modell, bestehend aus CROSSTEM, GEMINI-E3 und GENESwIS zu schaffen. Das Ziel dieser Kopplung ist es, eine noch umfassendere Analyse zu ermöglichen, insbesondere was die Auswirkungen der globalen und EU-Klima- und Energiepolitik auf die Schweiz betrifft.

Szenarien

Die Szenarien für diesen Bericht wurden entwickelt, um die Funktionsfähigkeit der Modelle zu testen und zu zeigen. Drei inländische Szenarien sind dabei hervorzuheben: Ein Basisszenario, ein Markt-instrumentenszenario (*TAX*) und ein Szenario, das mit einem Verbot von Gaskraftwerken zusätzliche Entscheidungen zu technologischen Restriktionen annimmt (*NoGAS*). **Diese Szenarien wurden ausgewählt, um einen der zentralen Vorteile des gekoppelten Bottom-up-Top-down-Modells zu veranschaulichen: Es ist für die gleichzeitige Analyse der Auswirkungen sowohl marktwirtschaftlicher Instrumente als auch technologieorientierter Restriktionen und Massnahmen geeignet.**

Lehren aus der Kopplung

Wesentliche Forschungsbeiträge des Projekts beziehen sich auf methodische Fragen, die aufkommen, wenn verschiedene Modelle auf möglichst konsistente Weise gekoppelt werden sollen. Bei der Entwicklung, Umsetzung und konsolidierenden Prüfung von ELECTRA-CH haben wir folgende Erfahrungen gemacht:

- Eine **sorgfältige Harmonisierung** der Modelle ist entscheidend für die erfolgreiche Kopplung und die Herstellung zuverlässiger Ergebnisse.
- Bottom-up- und Top-down-Modelle basieren auf verschiedenen Methoden und Logiken. **Die zu verknüpfenden Variablen müssen sorgfältig ausgewählt und interpretiert werden**, damit nicht Ungenauigkeiten oder logische Fehler im Modell entstehen.
- **Nachfragedämpfung** (Gauß-Seidel) ist ein wesentlicher Ansatz um die Konvergenz des Kopplungsalgorithmus zu erreichen.
- **Annahmen über die künftige Entwicklung der Strommarktregulierung verändern die ökonomischen Implikationen von Kopplungsvariablen und beeinflussen so die Ergebnisse.**

Das Vorhaben der Kopplung von CROSSTEM und GEMINI-E3 führte zu weiteren Fragen. Grund dafür ist vor allem die unterschiedliche Modellierung des internationalen Handels, sowohl hinsichtlich der Grundlagen für Einfuhr- und Ausfuhrpreisen als auch in Bezug auf die divergierenden Optimierungsansätze, mit denen die endogenen Handelsentscheidungen bestimmt werden: GEMINI-E3 hat einen repräsentativen Haushalt pro Region, von denen jeder seinen Nutzen maximiert; CROSSTEM

minimiert die gesamten Stromsystemkosten für die fünf Länder gemeinsam, was bedeutet, dass die Lösung nicht unbedingt optimal für jedes einzelne der fünf Länder ist.

Energieökonomische Lehren

Die Simulationen mit den beiden neuen Modelle bestätigen, wie wichtig es ist, alle relevanten Effekte in die modellbasierte Energiepolitikanalyse einzubeziehen: technische, intersektorale, internationale und allgemeine Gleichgewichtseffekte. Dies verändert die wirtschaftlichen Auswirkungen von Politikmassnahmen nicht nur leicht, sondern grundlegend, zumindest für einige Szenarien. Diese Schlussfolgerung kann zuverlässig gezogen werden, auch auf der Grundlage der wenigen Szenarien, die wir simuliert haben. Schliesslich sind die bedeutenden Auswirkungen veränderter Modellstrukturen auf die Ergebnisse sichtbar geworden. Die Richtung und das Ausmass dieser Unterschiede ist vor der jeweiligen Simulation schwer vorherzusagen, was ein Beleg für die Notwendigkeit ist, Modelle einzusetzen, die nicht unterkomplex sind. Wenn die untersuchte Fragestellung komplex ist, muss das Modell diese Komplexität abbilden, wenn es nicht zu falschen Schlussfolgerungen führen soll. In diesem Fall besteht die bekannte Herausforderung darin sicherzustellen, dass die komplexeren Modelle noch zuverlässige Ergebnisse produzieren und die einzelnen Wirkungen nachvollziehbar bleiben.

In den Simulationen mit dem gekoppelten ELECTRA-CH-Modell haben wir erfahren, wie technologiebasierte Kostenfunktionen Gewinne in die Null-Gewinn-Welt des CGE-Modells GENESwIS einführen und damit Gleichgewichtspreise und -mengen sowie die Wohlfahrtseffekte signifikant verändern. Zum Beispiel ist die Reduzierung der Nachfrage, die durch eine Stromsteuer ausgelöst wird, in ELECTRA-CH viel ausgeprägter als in den eigenständigen Versionen von GENESwIS, was im Modell weiterreichende wirtschaftliche Konsequenzen nach sich zieht. Dieses Ergebnis hängt eng mit den technologischen Optionen im Schweizer Stromsystem im simulierten Szenario zusammen und ist nicht auf andere Szenarien übertragbar. Diese Besonderheit **bestätigt, dass es wichtig ist, die technologischen Alternativen explizit zu simulieren, wenn man die Wirkungen von Marktinstrumenten in der Energiepolitik verstehen möchte**. Auf der anderen Seite wäre auch ein rein angebotsseitiger Bottom-up-Ansatz eindeutig nicht geeignet für die Analyse von Marktinstrumenten, weil die Nachfrageseite nicht dargestellt würde.

Die Bedeutung technologiebasierter Kostenmodellierung erschliesst sich auch, wenn man die Verbesserungen der Wohlfahrt betrachtet, die in ELECTRA-CH aus einem Verbot von Gaskraftwerken entstehen, wenn Nettostromimporte erlaubt werden, die dem Energiegehalt der vorigen Erdgasimporte entsprechen (*NoGAS*-Szenario). Die Vorteilhaftigkeit dieses Szenarios stellt übermässig vereinfachte Interpretationen von Versorgungssicherheit in Frage. Interessanterweise führt die Reduzierung der Gesamtsystemkosten im *NoGAS*-Szenario aber nur zu einem etwa halb so grossen Wohlfahrtsgewinn, was die Notwendigkeit der Modellierung der Interaktion der Stromerzeugung mit anderen Wirtschaftssektoren hervorhebt. Der geringere Wohlfahrtsgewinn ist auf eine Kombination mikroökonomischer und allgemeiner Gleichgewichtseffekte zurückzuführen, die in Abschnitt 3.1.3.6 erläutert werden.

Die politikrelevanten Effekte, die wir hier skizziert haben, können mit keinem der beteiligten Modelle eigenständig untersucht werden. CROSSTEM-CH operiert mit exogenen Nachfragen und übersetzt Kosten nicht auf mikroökonomisch konsistente Weise in Preise. Andererseits erfassen die Kostenfunktionen von GENESwIS die Unterschiede zwischen Durchschnittskosten und Grenzkosten der Stromerzeugung vollkommen unzureichend. **Die adäquate Analyse der Strommärkte verlangt inso-**

fern nach einem gekoppelten Modell. Mehr noch, die hier skizzierten Erkenntnisse zu wettbewerblichen Strommärkten sind ohne den innovativen Ansatz der Kopplung über Grenzkosten nicht zu erzielen. Das sonst übliche Verfahren der Kopplung von Top-down-Preisen mit Bottom-up-Durchschnittskosten mag einfacher zu implementieren sein, vor allem weil es bequem für die Modellkonvergenz ist; es ist aber unvereinbar mit der mikroökonomischen Theorie für Wettbewerbsmärkte und vernachlässigt Firmengewinne, die aufgrund der Differenz von Grenzkosten und Durchschnittskosten entstehen. Demzufolge berechnet man mit diesem verbreiteten Verfahren falsche Auswirkungen sowohl auf die Stromwirtschaft als auch auf die übrige Volkswirtschaft.

Für den langfristigen Stromerzeugungsmix offenbaren die Ergebnisse in diesem Bericht viele Zusammenhänge mit der übrigen Schweizer Volkswirtschaft und dem Ausland. **Der internationale Stromhandel hat sich als besonders relevant für die Ergebnisse erwiesen, wenn er wie in CROSSTEM auf der Basis der Grenzkosten endogenisiert ist.** Durch die Abbildung der Nachbarländer in CROSSTEM wird die kostengünstigste Konfiguration für die Stromerzeugung ermittelt. Darüber hinaus ermöglicht die stündliche Zeitauflösung, die Schwankungen von Angebot und Nachfrage im Zeitablauf zu erfassen, was z.B. bei der Beurteilung der Einsatzmöglichkeiten ungleichmässig liefernder erneuerbarer Energien hilfreich ist.

Forschungsausblick

Die Kopplung von CROSSTEM, GEMINI-E3 und GENESWIS bleibt eine lohnende Aufgabe, hauptsächlich um die Berücksichtigung von internationalen Einflüssen auf den Schweizer Elektrizitätssektor weiter zu verbessern. Darüber hinaus sollten in der Zukunft weitere Szenarien erforscht werden, um den bestehenden Modellrahmen weiter zu testen und fortzuentwickeln. So können die Modelle ihr volles Potenzial entfalten und besser fundierte Antworten gefunden werden bezüglich des Einflusses der in- und ausländischen Energiepolitik auf den Strommix, die Strompreise und die Wohlfahrt, um nur einige zu nennen. Solche Simulationen tragen auch zu einem besseren Verständnis der langfristigen Rolle der Schweizer Stromproduzenten im europäischen Stromsystem bei und beleuchten die Implikationen dieser Rolle für politische Entscheidungsträger und Verbraucher. Die Lehren aus zusätzlichen Simulationen helfen gleichzeitig dabei, die beiden bestehenden Modelle CROSSTEM und ELECTRA-CH weiter zu verbessern.

1 Introduction

1.1 The ELECTRA research program

This is the report for the 3 ½ year research project *Electricity markets and trade in Switzerland and its neighbouring countries* (ELECTRA). It was carried out from July 2011 to January 2015 by three institutions and involved two PhD students and six senior researchers and modelers. The main goal of the project has been to create new coupled modeling frameworks for energy policy analysis in Switzerland which can be employed to answer research questions such as

- How do EU climate and energy policies with implications for the European electricity mix affect Switzerland?
- How do global climate policy and fossil fuel scenarios affect substitution between energy carriers and especially electricity demand in Switzerland?
- What are the effects of political decisions which influence technology choices in electricity generation on the rest of the Swiss economy?
- How do long-term electricity pricing and sectoral profits depend on cost structure and technology mix?
- Given the advanced stage of integration of the European electricity market, does the view on Swiss energy dependence in electricity supply change when we endogenously model imports and exports on an hourly basis?

The simulations described in this report do not fully answer all of these research questions. They have been designed to test and illustrate the functioning of the new model frameworks. With more simulations in the future, more aspects of these research questions can be explored.

As could be expected for a major modeling and coupling endeavor, a lot of the tasks in this project have been rather technical. Because of this, much of the progress made has been on methodological issues which arise when different types of models should be robustly coupled with the best consistency achievable. Hence, it does not come as a surprise that major parts of the project output in terms of scientific publications are going to apply to this area. At this early point of the report, we don't want the explanations to become too technical, so we merely mention some of the related fields of interest:

- How can bottom-up and top-down model logic and data be reconciled to achieve maximum consistency of a coupled framework?
- In a coupled framework, which model's representation should be prioritized over the others' for which kind of relationships?
- What variables need to be exchanged and how should they be interpreted by the receiving model?
- What does the shadow price of electricity in a bottom-up model exactly represent in equilibrium economic terms?
- How to couple costs and prices given a market environment that is characterized by gradual liberalization (see also the working paper in chapter 3.1.2)?
- How to help the framework reach convergence?

During this project, we finalized two major model developments:

- The technology-rich multiregional Cross Border TIMES Electricity Model (CROSSTEM), of five countries (Austria, France, Germany, Italy and Switzerland), which uses the TIMES cost optimization framework.
- The coupled framework ELECTRA-CH, which consists of the Swiss region of the CROSSTEM model (CROSSTEM-CH) and of the dynamic CGE model for the Swiss economy GENESwIS. ELECTRA-CH integrates a multisectoral general equilibrium representation of the Swiss economy with a detailed technology-based representation of electricity supply.

We have also taken important steps towards linking CROSSTEM with GEMINI-E3, which is a multi-regional CGE model of the global economy, in order to create the coupled ELECTRA framework consisting of CROSSTEM, GEMINI-E3 and GENESwIS. The goal of this coupling is to enable an even more integrated analysis, especially concerning the impact of global and EU climate and energy policies on Switzerland.

1.2 CROSSTEM

In order to understand the future development pathways and technology options for the Swiss electricity system, it is necessary to analyze the transition in conjunction with the development of the EU electricity market, most importantly the four countries bordering Switzerland. Thus, we developed an electricity model of Switzerland and its four neighbouring countries - the CROSs border Swiss TIMES Electricity Model (CROSSTEM). The model minimizes cost of electricity supply for an exogenously given electricity demand. It covers a long time horizon (to account for long term policy goals and investment decisions), while simultaneously representing sufficient intra-annual detail (i.e., seasonal, weekly and hourly) to account for temporal variations in electricity supply and demand. It is an extension of the Swiss TIMES Electricity model (STEM-E), which was proven to be very useful in addressing Switzerland-specific policies, but has limitations due to relying on exogenous assumptions on electricity import/export prices, uncertainties on sources of electricity import and market for electricity exports. Some of these limitations have been addressed in CROSSTEM, in which electricity trade between Switzerland and its neighbouring countries becomes endogenous based on marginal costs of supply, subject to technical and environmental constraints. Hence, CROSSTEM generates insights into transition pathways for the Swiss electricity system by taking into account developments in the neighbouring countries. To showcase the usefulness of this new tool, a limited set of scenarios is presented in this report.

1.3 ELECTRA-CH

ELECTRA-CH is a coupled bottom-up top-down framework designed to analyze the Swiss electricity market under environmental and energy policies, and its link to the Swiss economy. It is composed of two component models:

1. The Swiss region of the technology-rich bottom-up model Cross Border TIMES Electricity Model, CROSSTEM-CH;
2. The dynamic multi-sectoral Computable General Equilibrium (CGE) model of the Swiss economy GENESwIS.

These two models are coupled through an iterative soft link. The advantage of a soft link is to prioritize each model's strengths, while keeping each model's full structure, detail and integrity. In ELECTRA-CH, the representation of electricity supply from the CROSSTEM-CH model is prioritized over that of the GENESwIS model. The endogenous demand variations of the GENESwIS model are then prioritized over the fixed input demand of the CROSSTEM-CH model. Moreover, sectoral prices feedback from the GENESwIS model is used to modify capital and operational costs of technologies in CROSSTEM-CH. This way, results are better informed (from the prioritization), and detailed (due to the fact that we have two specialized models). They include both technological detail and general equilibrium feedback of the economy.

1.4 Scenarios

The scenarios analyzed for this report have been designed to test and illustrate the functioning of the modeling frameworks. They include domestic and international scenarios.

1.4.1 Domestic scenarios

Three domestic scenarios are analyzed: A baseline scenario, a market instrument scenario (*TAX*), and a scenario putting forward technological restrictions with the prohibition of gas power plants (*NoGAS*). These scenarios were chosen to illustrate one of the central advantages of coupled bottom-up top-down frameworks: They are suitable for analyzing the effects of both market instruments and technology-oriented restrictions and policies. A comparison of the main instruments of the domestic scenarios can be found in Figure 1.

		Baseline	TAX	NoGAS
Market instruments (GENESwIS)	ETS		Same as baseline	Same as baseline
	CO ₂ tax on heating fuels 36CHF/t(2010) 72CHF/t(2020-50)		CO ₂ tax on heating fuels 72CHF/t (2020) 200CHF/t (2050)	Same as TAX
			CO ₂ tax on transport fuels 50CHF/t (2035) 200CHF/t (2050)	Same as TAX
			Electricity tax 10%(2020) 50%(2050)	Same as TAX
Regulation (CROSSTEM)	No net import (yearly average)		Same as baseline	Net import (same total energy [PJ] as imported gas)
				No gas power plants

Figure 1: ELECTRA domestic scenarios: comparison of the policy instruments.

The baseline scenario is based on the “weiter wie bisher” (i.e. business as usual) scenario of the Energy Perspectives 2050 (Prognos 2012). It includes current policies:

- An Emissions Trading Scheme (for ETS sectors, including air transport from 2020 onwards). CO₂ permit prices are exogenously set on Prognos 2012 projections (Table 11, page 70).

- A CO₂ tax on heating fuels for the non-ETS sectors. Tax rates are set at 36 CHF/t in 2010, 60 CHF/t in 2015 and at 72 CHF/t from 2020 to 2050.
- A subsidy program for the energy refurbishment of buildings (280 mio CHF/year from CO₂ tax revenue).

A constraint on net trade of electricity is implemented such that, on annual average, Switzerland may not import more than it exports in quantity terms.

The *TAX* scenario represents more stringent climate and energy policies:

- A tax is levied on electricity consumption at a rate of 10%¹ in 2020 and increasing linearly to 50% in 2050.
- The Emissions Trading Scheme is the same as in the baseline scenario. It also has the same assumed permit prices.
- The CO₂ tax on heating fuels is increased linearly from the 2020 level to 200 CHF/t in 2050.
- A CO₂ tax on transport fuels is introduced at 50 CHF/t in 2035, reaching 200 CHF/t in 2050.

The *NoGAS* scenario features the same market instruments as the *TAX* scenario. The difference lies in the prohibition of gas-fired power plants in the Swiss electricity sector. Additionally, the annual net trade constraint is relaxed. Net imports are allowed, with an upper limit equivalent to the quantity of gas (in PJ) imported by gas-fired power plants in the *TAX* scenarios. This is a rather simplistic attempt at keeping a similar level of overall energy supply security, even if imports of electricity and natural gas do not imply the same level of security risks. The relaxation of the net electricity trade constraint was necessary, because the domestic renewable potentials are not adequate to supply the baseline demand, and hence the framework did not converge to a single solution for an even more restrictive scenario.

The phase-out of nuclear power plants at the end of their lifetime is included in all scenarios.

1.4.2 International scenarios

The international scenarios include a current policy “Baseline” and a “Moderate stringency” climate change mitigation scenario. These scenarios are analyzed in section 2.3.4 with the GEMINI-E3 model and have been developed so they can also be simulated with the ELECTRA framework. The scenarios follow a review of selected MiniCAM – BASE scenarios² (see Calvin et al. 2009, Clarke et al. 2008).

For the **Baseline** scenario, MiniCAM scenario S1_3p7_OS³ was selected as a starting point. To account for existing policies in the EU until 2050, the allocation of the global emissions trajectory was

¹ This tax is levied on retail electricity consumption. Retail electricity prices include transport and distribution costs as well as value added tax.

² MINICAM, which has recently be renamed GCAM, is a dynamic-recursive, technology-rich integrated assessment model by the Joint Global Change Research Institute, which is based in Maryland, USA. The MINICAM-BASE scenarios were developed for EMF22, more specifically for its international scenarios study, which analyzed carbon concentration pathways with the possibility to overshoot concentration limits before drastically abating as well as the possible delayed participation of some countries to mitigation efforts.

³ “S1” refers to global participation; “3p7” refers to a radiative forcing target of 3.7 Wm⁻²; “OS” indicates a temporary overshoot of the target

adjusted to match the estimated emissions in the EU under “Current Policy” as defined in the EU Roadmap (European Commission 2011a).

For the **Moderate stringency** case, the global emissions trajectory in MiniCAM scenario S1_3p7_S⁴ was selected as consistent with a more ambitious Swiss policy to 2050. To account for additional abatement activity in the EU, this global trajectory was adjusted as above to match the additional nearer-term (to 2030) EU Roadmap emissions pathway (European Commission 2011a), but not the more normative/aspirational 2050 EU mitigation goals.

The emissions trajectories for the EU and the rest of the world are presented in Figure 2 and Figure 3.

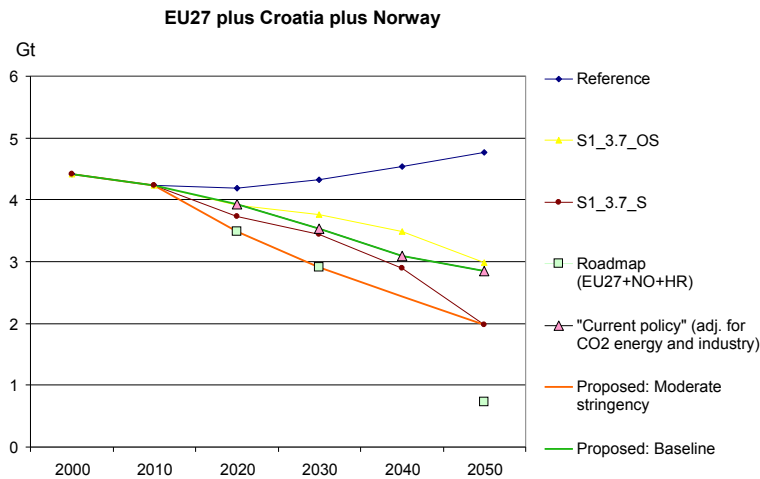

Figure 2: CO₂ emissions in Gt from fossil fuel & industry for the EU (incl. Croatia) and Norway

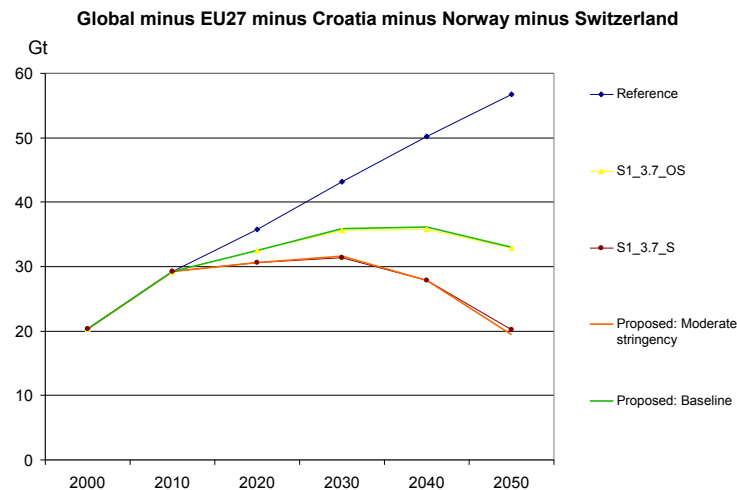

Figure 3: CO₂ emissions in Gt from fossil fuel & industry for the World minus EU (incl. Croatia) minus Norway minus Switzerland

⁴ “S” indicates a stabilization target (rather than an overshoot). It should be noted that while both S1_3p7_OS and S1_3p7_S were developed to achieve similar long-term climate targets (of 3.7 Wm⁻² radiative forcing), the selection of these scenarios should not be viewed as necessarily implying similar long-term trajectories in the Baseline and Moderate stringency cases in ELECTRA.

1.5 Report structure

Chapter 2 presents model descriptions of the three models that we have further developed and employed. It also contains a few illustrative simulations performed with these models, i.e. simulations with single models without any coupling to the other models. We start by presenting CROSSTEM (section 2.1), which has largely been developed within this project, especially the representation of electricity supply systems for the neighbouring countries of Switzerland. The computable general equilibrium models GENESWIS and GEMINI-E3 follow in sections 2.2 and 2.3, respectively.

Chapter 3 concerns the bottom-up top-down coupling that has taken place in this project. Section 3.1 deals with the coupled ELECTRA-CH framework. It includes details on the coupling methodology (3.1.1), a draft paper on linking costs and prices in changing market environments (3.1.2), and an analysis of simulation results for three energy policy scenarios (3.1.3). Section 3.2 reports on the current state of the coupling efforts for the international ELECTRA framework. It includes the motivation for the coupling (3.2.1), an overview of the coupling methodology developed for ELECTRA (3.2.2), the state of the coupling at the time of the report writing (3.2.3), and steps in view of further research (3.2.4).

Chapter 4 concludes with respect to the lessons learned and the new opportunities for energy policy analysis in Switzerland that this project has created.

2 The three models

2.1 CROSSTEM

2.1.1 Background

In 2011, the Swiss Federal Council decided to phase out nuclear energy (FASC 2011; UVEK 2010). With a view on the new Swiss Energy Strategy 2050, a report was commissioned regarding the energy perspectives until 2050 for Switzerland (Prognos 2012). This report forecasts three electricity demand scenarios and a number of electricity supply variants. New natural gas-fired power plants, extensive deployment of domestic renewables, and/or imported electricity are seen as possible future electricity supply options. There are several trade-offs between these supply options in terms of costs, climate change mitigation policies, electricity supply-demand balancing, electricity supply security etc. In particular, the source of imported electricity is a source of great uncertainty and highly depends on political and technological development in the four countries bordering Switzerland and the European electricity market, given that a stronger integration of the EU energy market has been proposed for improving economic efficiency and security of supply across the member countries (European Commission 2010). The policies within Europe are also aimed at moving towards an energy system with larger contribution from renewable sources of energy (European Commission 2011a), likely increasing the share of decentralized/intermittent renewable technologies, which would make the supply and demand balancing even more complex.⁵ Accordingly, to understand the plausible future development pathways of the Swiss electricity system, it is necessary to analyze it in conjunction with the development of the EU electricity market in general and the bordering countries in particular.

There are several Swiss specific analytical tools (Atukeren et al. 2008; Laurent et al. 2005; Ochoa/van Ackere 2009; Operations Research Decisions and Systems (ORCDECSYS) 2011; Prognos 2010; Schlecht/Weigt 2014; Weidmann et al. 2012) that have helped in understanding the development of the Swiss electricity system in one way or the other. But these models either consider only shorter term impacts (i.e., pure dispatch models such as SwissMod by Schlecht/Weigt 2014), or focus solely on the long-term development without having detailed intra-annual time resolutions (e.g. Swiss Markal Model by Weidmann et al. 2012). The Swiss TIMES Electricity Model (STEM-E) developed at PSI (Kannan/Turton 2011) was the first attempt at combining these features, and has enabled the understanding of plausible transition pathways for the electricity sector. The model has a very detailed depiction of the Swiss electricity system, but being a single region model, has a very simplified representation of electricity import and export, thereby falling short when addressing some of the uncertainties associated by technology deployment or electricity import from the neighbouring countries.

On the other hand, there exist numerous European electricity models (DLR 2013; EWI 2008; Gutschi et al. 2009; Johnsson 2011; Lohwasser/Madlener 2009; Reiter 2010; Simoes et al. 2013; von Weizsäcker/Perner 2001; Voogt 2001). Despite their usefulness, these EU models have their limita-

⁵ However, Switzerland with its large dam hydro resources and the potential for pumped hydro storage may be well placed to exploit opportunities presented by a more renewable-intensive European electricity system.

tions in addressing Swiss-specific electricity, climate and energy policies because in almost all cases the representation of Switzerland is highly aggregated or simplified. Moreover, most of these existing tools do not combine long time horizons with detailed electric load curve representations (see Figure 4). Combining a high level of intra-annual details and horizons in a technologically explicit model at the EU level would be complex and challenging to solve (Connolly et al. 2009; Johnsson 2011; Pfenninger et al. 2014; Welsch et al. 2014).

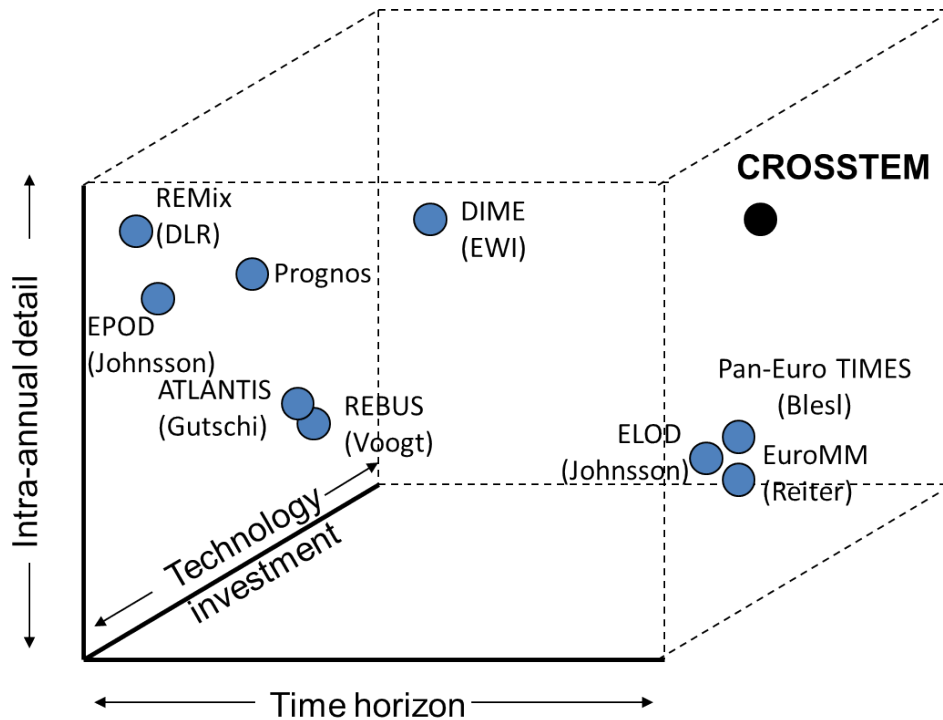

Figure 4: European electricity models

Given the availability of the STEM-E model and its proven usefulness in addressing Swiss specific policies (Kannan/Turton 2012), the idea of extending the STEM-E model to include the four neighbouring countries has been undertaken in the ELECTRA project. This new model, CROSSTEM (**CROSS**-border **Swiss TIMES Electricity Model**), addresses most of the aforementioned uncertainties and, as Switzerland’s four neighbours account for over half of the EU electricity generation, impacts of EU-wide policies on Switzerland can be captured (Pattupara/Kannan 2014a and 2014b).

2.1.2 Analytical framework

The analytical framework used to develop the CROSSTEM model is TIMES (The Integrated **MARKAL**⁶/**EFOM**⁷ System framework) (Loulou et al. 2005). TIMES is a perfect foresight, cost optimization modeling framework, which identifies the “least-cost” combination of technologies and fuel mix based on the operational characteristics and availabilities of the technologies, to satisfy exogenously given energy (or in our case electricity) demands. Technology characteristics such as investment costs, operational and maintenance costs, fuel resource costs and availability, energy conversion efficiencies, availability factors, construction times/costs, decommissioning costs etc. can

⁶ MARKAL – **MARKet ALlocation**.

⁷ EFOM – **E**nergy **F**low **O**ptimisation **M**odel

be incorporated into the model (Loulou et al. 2005). TIMES allows for prospective analysis over a long time horizon (50+ years), while at the same time being able to represent a high level of intra-annual detail in demand and supply (e.g. load curves). It also has an enhanced storage algorithm, enabling the modeling of pumped (and other electricity) storage systems (ETSAP 2008). The TIMES framework is particularly suited to explore possible energy futures based on contrasted “what-if” scenarios. An overview of the TIMES framework is shown in Figure 5.

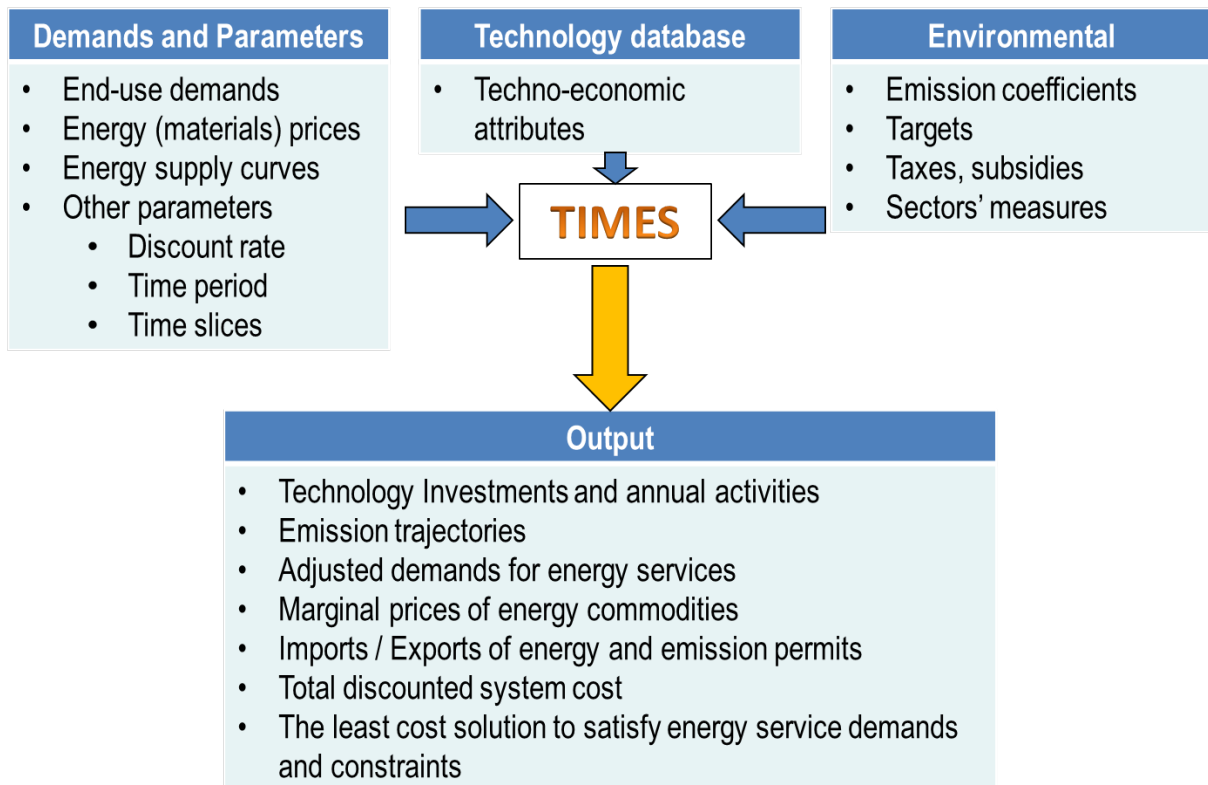

Figure 5: TIMES model flow diagram (Source: Gargiulo 2013)

2.1.3 Model development

CROSSTEM is developed using a TIMES input data interface known as VEDA (Versatile Data Analyst). The data flow of the VEDA interface is shown in Figure 6. Data and scenario assumptions are fed into the TIMES code via the VEDA-Front End (FE), which converts inputs from Excel files to a GAMS readable format. The TIMES equations are solved in the GAMS environment with the CPLEX solver, producing a text output which is imported in the VEDA-Back End (BE) to analyze model outputs (Kanors 2008).

2.1.4 Model structure

The basic model structure consists of the number of regions, time horizon, number of inter-annual time slices, currency units etc. which are described in the following subsections.

2.1.4.1 Regions

CROSSTEM is an extension of the STEM-E model, covering the whole electricity system of Switzerland (CH) and its four neighbouring countries, viz. Austria (AT), France (FR), Germany (DE) and Italy (IT). In addition to this, there is an implicit external region termed “Fringe”, which represents the fringe

countries of the CROSSTEM regions (see Figure 7). This region is defined to account for the electricity trade between the CROSSTEM countries and their neighbours (e.g. electricity trade of Germany with Denmark, Poland etc.). This external region (also referred to as the rest of the world) also accounts for imports and exports of energy commodities (e.g. gas, uranium).

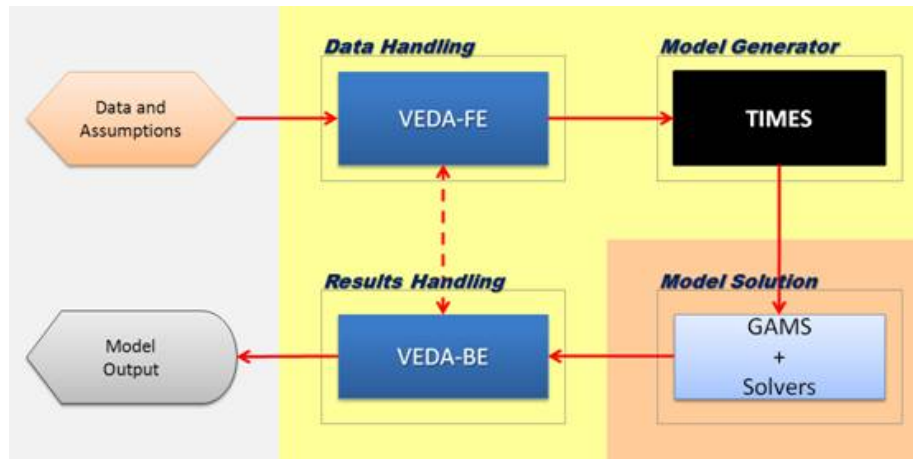

Source: Kanors 2008

Figure 6: VEDA system for TIMES modeling

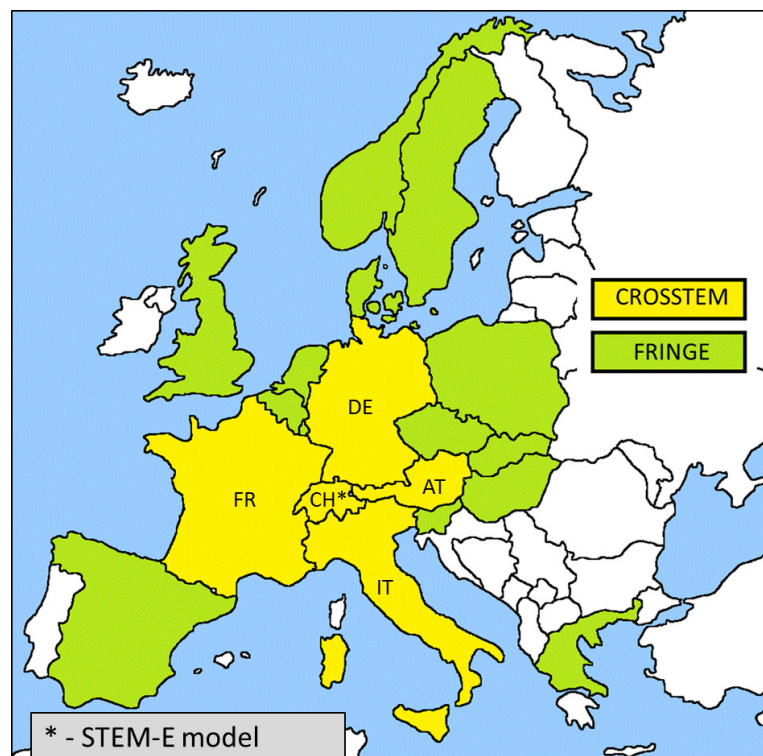

Figure 7: CROSSTEM and "FRINGE" regions

2.1.4.2 Time horizon

CROSSTEM has a time horizon of 60 years (2010-2070) divided into 14 unequal time periods. The first two periods consist of one (2010) and two (2011-2012) years, respectively, for model calibration

purposes, while the rest of the time horizon has 12 five-year periods (see Table 1). All years within a time period are considered identical, with all the quantities (capacities, commodity flows, operating levels etc.) applying to each year in the period, except capacity investment which is usually made only once in a period (Loulou et al. 2005). The middle year of a time period is known as the milestone year and results are displayed for the milestone years. For example, the year 2015 represents the time period 2013-2017 (see Figure 8 and Table 1). The TIMES framework is flexible to modify the length of the periods and milestone years.

Table 1: Modeling time horizons in CROSSTEM

Period number	Period length (years)	Actual time periods	Milestone year
1	1	2010	2010
2	2	2011-2012	2011
3	5	2013-2017	2015
4	5	2018-2022	2020
↕	↕	↕	↕
13	5	2063-2067	2065
14	5	2068-2072	2070

2.1.4.3 Time slices

In addition to time periods, the model also has time divisions within a year, and these are known as (intra-annual) time slices (see Table 2). The CROSSTEM model represents 4 seasons in a year (Spring, Summer, Fall and Winter) and three different types of days in a week (Weekdays, Saturdays and Sundays), to model the variations in electricity demand and supply patterns of the regions (see also Kannan/Turton 2011). Each day is further split into 24 hours, thereby enabling the representation of hourly load-curves for demand and supply (see Figure 8). Thus, the 8760 hours of a year are represented in the model with 288 representative hours (time slices).

Table 2: Definition of seasonal and inter-annual time slices in CROSSTEM

Seasonal	Weekly days	Diurnal hours
Summer (SUM-): June – August	Weekdays (WK-): Monday – Friday	D01, D02, D03, D24
Spring (SPR-): March – May	Saturdays (SA-): Saturdays	
Winter (WIN-): December – February	Sundays (SU-): Sundays and Swiss national holidays	
Fall (FAL-): September – November		

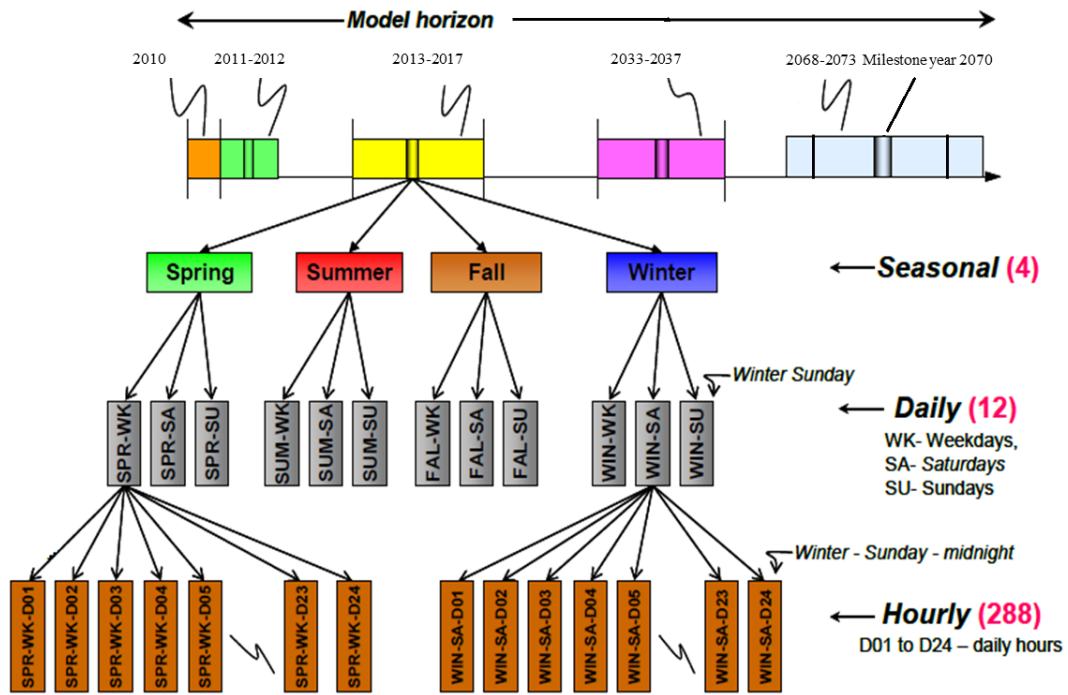

Figure 8: Intra-annual details in CROSSTEM

2.1.4.4 Currency unit

The objective function of the model is the discounted sum of all the annual electricity systems costs over the entire time horizon (discounted to the base year 2010). All cost data is given in Swiss Francs from 2010 (CHF₂₀₁₀).

For the analysis presented in this report, a discount rate of 4.5% has been used for the entire model horizon, in conjunction with the discount rate used in the GENESwIS and GEMINI-E3 models (see section 2.2.4.1). This discount rate is used to calculate the annuities on capital investments, as well as to discount the future costs. Technology specific discount rates could be applied, but have not been used for this project. The discount rate is a parameter for future sensitivity analysis.

2.1.5 Reference Energy System (RES)

A reference energy system connects all the different elements in the electricity system, from primary energy resource supply to end use electricity demand, and is represented in CROSSTEM for all the five regions. There are around 200 technologies⁸ interconnected by more than 60 commodities⁹ to define the whole electricity system. The technologies in the model include a range of electricity power plants, interconnectors for electricity trade between regions, ad-hoc electricity distribution grid, storage technologies (pumped hydro storage), etc. Commodities include primary energy resources (natural gas, oil, hydro etc.) to end use demands and emissions, which connect the various technologies. Figure 9 shows a section of the RES from CROSSTEM.

⁸ Process technologies in TIMES include a range of technologies, which are classified into the following groups according to their role in the energy system: Electric power plants (ELE), Storage plants (STG), inter-regional exchange (IRE), demand devices (DMD), renewables (RNW), mining (MIN), imports/resources (IMP).

⁹ Commodities can also be classified as: Energy (NRG), emissions (ENV), demand (DEM), material (MAT) and financial (FIN).

Primary resources are modeled as either renewables or imported fuels, which feed into electricity generation technologies. Electricity generated from these technologies can be used at the end-use sectors, exported to other regions in the model, or stored. CO₂ from fossil fuels are tracked at the resource consumption level. The following sections describe the various RES components in detail. Only aspects common to all regions are described in the following subsections, with country-wise specifics given in the appendix (see Appendix A).



Figure 9: Illustration of the Reference Energy System (RES) in CROSSTEM

2.1.6 Electricity end use sectors

Electricity demand is modeled as energy service demand (ESDs). The Swiss region has five end use sectors viz. residential (R), service (S), transport (T), industry (I) and agriculture (A) so as to be synchronized with the end use sectors in the CGE model. The other four regions (Austria, Germany, France and Italy) have one aggregated electricity end use sector each.

Electricity demand is one of the key exogenous¹⁰ inputs to the model. Literature is abundant with projections of different electricity demand trajectories using various modeling frameworks and demand drivers such as population growth, economic development, national and EU policies, technology spillover etc. (Andersson et al. 2011; Prognos 2012; Densing et al. 2014; European Commission 2013).

Figure 10 shows the electricity demand assumptions in CROSSTEM for the scenario analysis presented in section 2.2.4.1. The electricity demand for Switzerland is taken from the *weiter wie bisher* scenario of the Energy Perspectives 2050 (Prognos 2012). For the four surrounding countries, electri-

¹⁰ Although the electricity demand is taken from the CGE and GEMINI-E3 models in the coupled framework, a reference demand is given exogenously for the first iteration to produce a reference price for the top-down model.

city demands are taken from the reference scenario of the EU Trends to 2050 study (European Commission 2013), which incorporates all binding targets set out in the EU legislation regarding development of renewable energy and reductions of greenhouse gas (GHG) emissions, as well as the legislated energy efficiency measures.

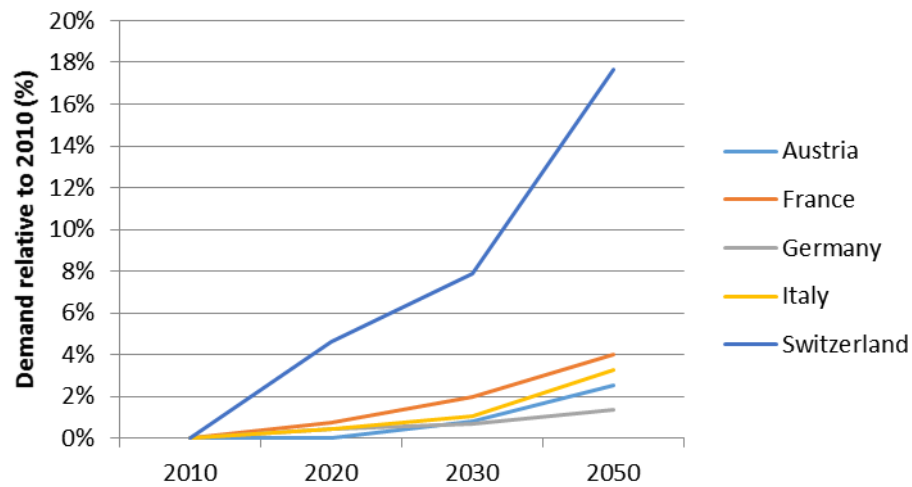

Figure 10: CROSSTEM Electricity demand evolution

For the intra-annual variations in electricity demand, electricity load curves from the year 2010 (ENTSO-E) are adopted for all countries for the entire model horizon. For example, Figure 11 shows the average electricity demand curves for Italy in 2010 (refer to Appendix A for other countries). However, the assumption of using 2010 load curves for future years does not take into account for instance the increasing electrification in the transport sector or space heating applications in the future (e.g. electric vehicles, heat pumps), which could significantly alter the shape of the load curves.

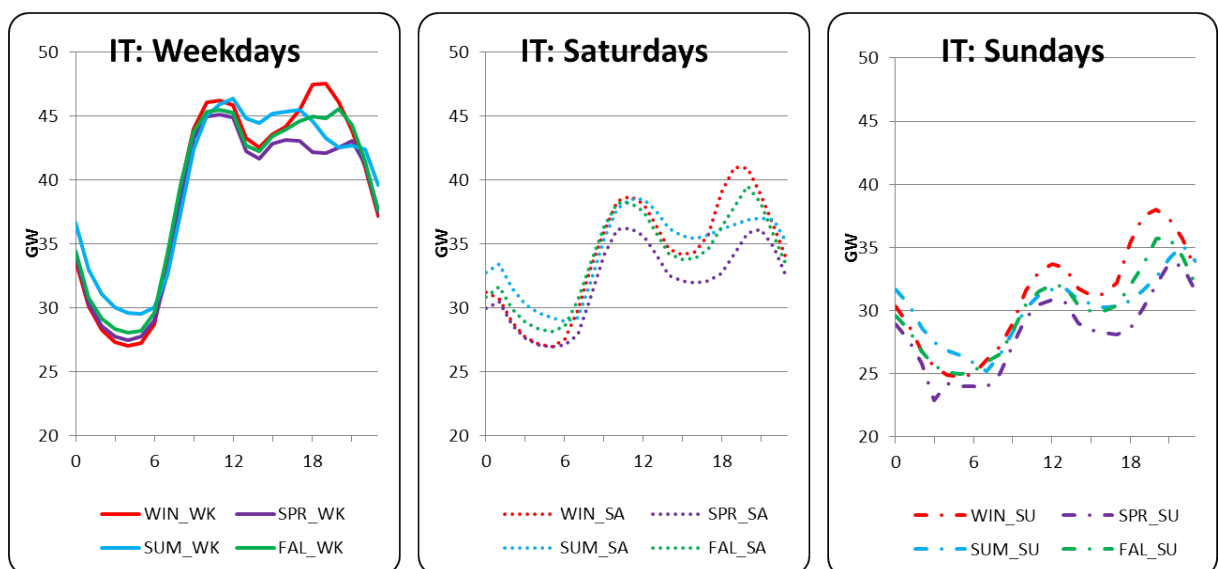

Figure 11: Electricity load curve 2010 (Italy)

2.1.7 Electricity generation technologies

Electricity supply to the end-use sector(s) can be produced with a range of existing and new electricity generation technologies, which are described in the following subsections. Since there is no representation of heat demand in CROSSTEM, combined heat and power (CHP) technologies are not modeled. For model calibration purposes, existing CHP technologies are added to an equivalent fuel-based electricity generation technology. For example, natural gas CHP generation is allocated to gas power plants.

2.1.7.1 Existing technologies

All the existing electricity generation technologies in 2010 from the five countries have been included at an aggregated level by fuel and technology. A list of existing technology categories with their capital stock and technical characteristics for each country is given in Appendix A. The model is calibrated for 2010 (see Figure 12) using OECD & ENTSO-E databases (ENTSO-E 2013; OECD iLibrary), as well as data from the respective national statistics (BFE 2010; BMLFUW 2009; BMWi 2011; European Energy Exchange 2014; Réseau de transport d'électricité 2012; TERNA 2014).

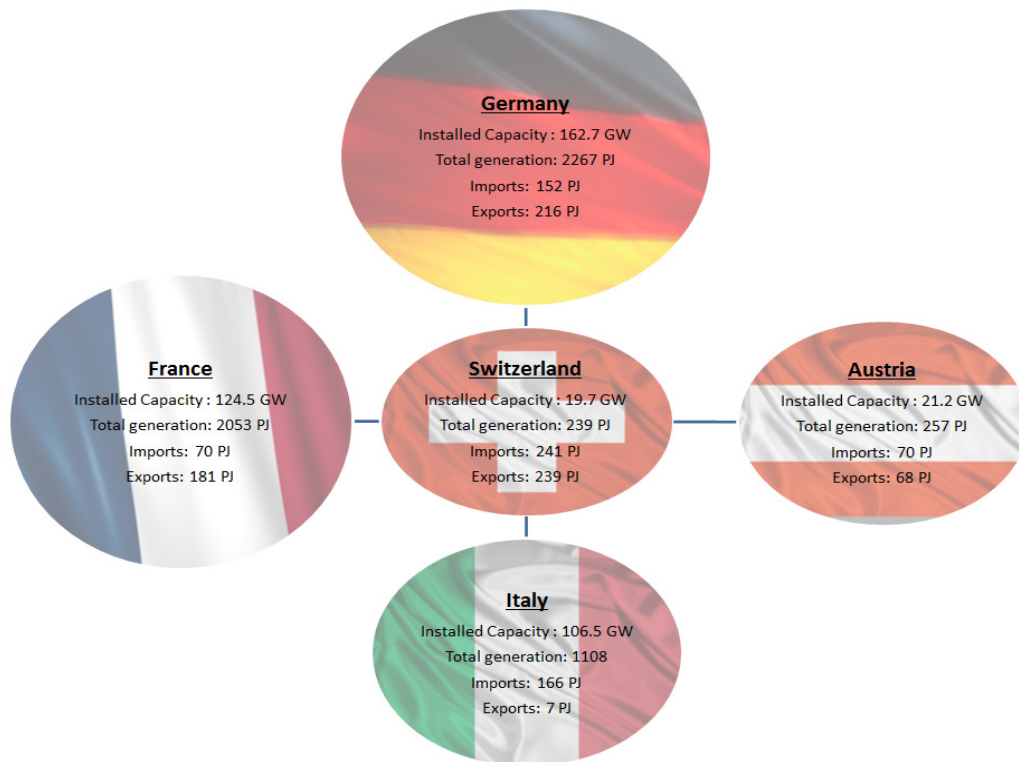

Figure 12: Electricity statistics 2010

All the existing technologies have fixed and variable operation and maintenance (O&M) costs, which are assumed to be the same as for the corresponding future technologies (see Table 5). Capital costs have been included for certain technologies¹¹, purely for purposes of coupling with the CGE model, which requires annuities of existing capital stock. Thus, we assumed capital costs similar to the values used for new technologies. However, this assumption does not affect the model solution, because (a)

¹¹ Mainly for capital intensive technologies like hydro, nuclear, solar PV and wind technologies.

electricity generation from existing technologies is based on their O&M and fuel costs; and (b) when two scenarios are compared, the annuity of existing stock would balance out. Capacity factors¹² and efficiencies have been calculated for the last decade (2000-2010), at the aggregated technology level, and their statistical averages are applied across the technologies for the future years.

2.1.7.2 Hydro power

Hydro power plants are classified into three categories – dam-, river- and pumped storage hydro. The river hydro is further split into two sub categories (small and large) for countries where data is available (namely Switzerland and Italy). All hydro plants are assumed to have a lifetime of 80 years, with existing plants having to be retired or refurbished at the end of their life. Refurbishment is assumed to be the replacement/repair of existing equipment (turbine/generator) and/or desilting the reservoir. The cost of refurbishment is assumed to be 35% of the investment cost of a new hydro power plant (Kannan/Turton 2011).

Since there are no large variations within daily or weekly outputs of river hydro plants, they have been modeled as seasonal base-load power plants, i.e. output within a season remains stable, subjected to their seasonal availability factors. Monthly river-hydro availability factors of Switzerland and the four neighbouring countries are shown in Figure 13, based on which the seasonal availability factors are estimated (BFE 2010; E-Control 2014; ENTSO-E 2013; personal communication with M. Gaeta, ENEA Italy 2014). Swiss data was adopted from the STEM-E model (see Appendix A).

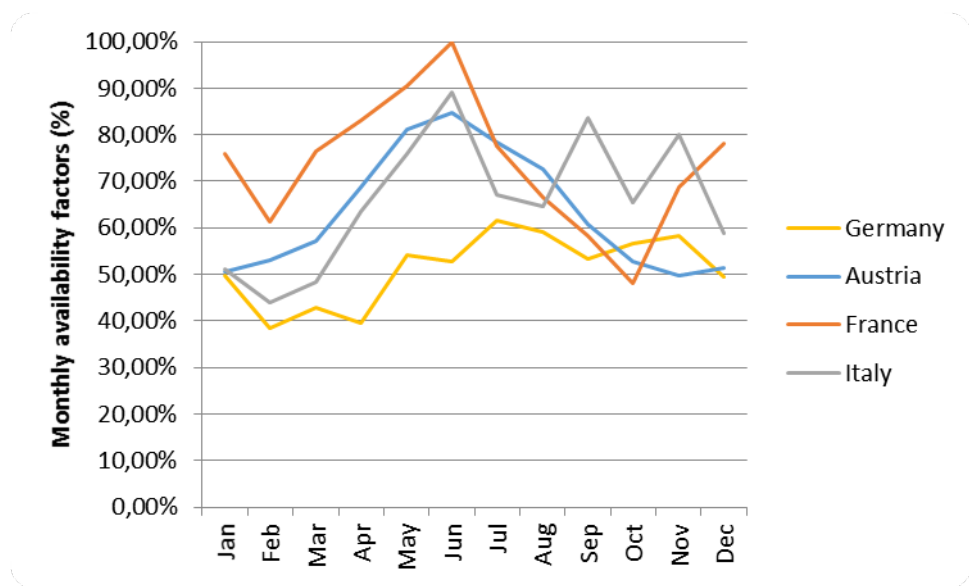

Figure 13: Monthly availability factors for river run-off plants

Dam and pumped hydro plants are modeled as flexible (i.e. dispatchable) electricity generation technologies, subjected to seasonal availability of reservoirs. Similar to river hydro plants, dam hydro plants also have seasonal variations¹³, which are represented by seasonal maximum availability factors and are shown in Table 3 (BFE 2010; E-Control 2014; ENTSO-E 2013; TERNA 2014). A minimum and maximum availability factor has also been implemented at the daily level to prevent the

¹² Capacity factors are used as availability factors of the existing technologies for the future years.

¹³ Seasonal variations are estimated based on monthly electricity generation and installed capacity.

dam hydro plants from running only during weekdays, when the electricity demand and costs are higher than on Saturdays and Sundays.

Table 3: Seasonal availability factors for dam hydro plants

	Summer	Winter	Fall	Spring
Austria	29%	25%	37%	9%
Switzerland	32%	22%	38%	9%
Germany	28%	23%	23%	26%
France	26%	28%	19%	29%
Italy	31%	21%	23%	25%

The pumped storage system is modeled as an intra-annual storage technology (STGTSS). Electricity can be stored at hourly or daily levels, while seasonal storage (storage of summer electricity for winter supply) is not enabled. A storage and conversion loss of 20% is assumed for the pumped hydro plants (Kannan/Turton 2011).

2.1.7.3 Nuclear power

Nuclear power plants are characterized as seasonal base-load plants. For Switzerland, all five nuclear plants are modeled individually, whereas for Germany and France, the total capacity is represented at an aggregated level. Figure 14 shows the retirement schedule of nuclear plants in the three countries. All the existing plants in Switzerland and France are assumed to have a lifetime of 50 years, whereas plants in Germany are phased out by 2022 according to their national strategy (World Nuclear Association 2014).

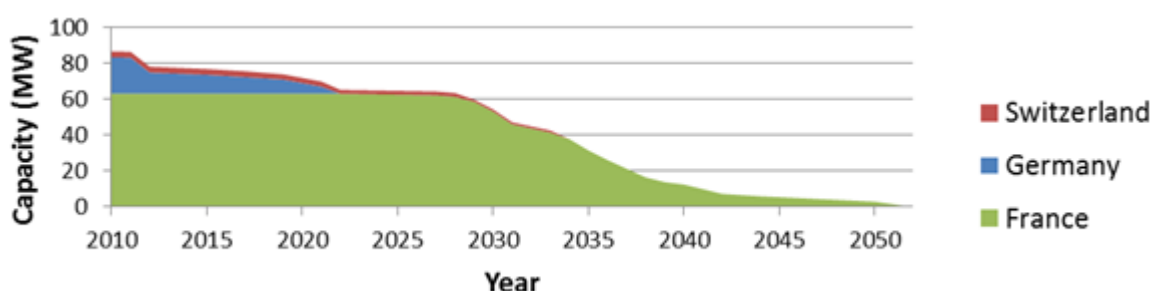

Figure 14: Retirement schedule of existing nuclear capacity

All the nuclear plants have an annual availability factor, as well as seasonal availability factors. Seasonal variability of nuclear plants arises mainly due to varying demands between seasons, as well as scheduled maintenance operations carried out during low demand seasons (typically summer). Seasonal (ENTSO-E) and annual (OECD iLibrary) availability factors are estimated based on historical generation, and are given in Table 4.

Uranium for the nuclear power plants is modeled as an imported fuel. The spent fuel from the nuclear reactor is not traced, which implies that there are no cost data for spent fuel reprocessing or nuclear waste disposal in the model. However, a federal levy of 0.2 Rappen/kWh for the decommissioning funds (*Stilllegungsfonds für Kernanlagen*) and 0.8 Rappen/kWh for the disposal funds (*Entsorgungsfonds für Kernkraftwerke*) are modeled as tax on electricity from nuclear plants in Switzerland (BFE 2014; Kannan/Turton 2011). For consistency, the same approach has been adopted for France and Germany.

Table 4: Nuclear park availability factors

	Germany	Switzerland	France
Annual	85%	93% ¹⁴	81.5%
Summer	76%	68%	69%
Winter	95%	98%	98%
Spring	79%	96%	80%
Fall	91%	84%	79%

2.1.7.4 Thermal power

All large thermal power plants other than nuclear (i.e. gas, coal, oil, and biomass/waste) are modeled as base load power plants. The model also has provisions for a flexible gas power plant to operate as a dispatchable or load following plant. These flexible power plants are assumed to have an efficiency penalty to reflect ruptured/part-load operational characteristics.

As mentioned before, since there is no heat demand, CHP technologies are not modeled and electricity generation from the existing CHP generation is allocated to the respective electricity generation technology. Historical average capacity factors are applied as the availability factors (of existing technologies) for the future years.

2.1.7.5 Renewables

New renewable technologies (non-hydro) such as solar photovoltaic (PV) and wind (onshore and off-shore) are characterized with country specific hourly availability factors. All other renewable technologies such as geothermal and tidal are modeled as seasonal base-load plants. Efficiency is assumed to be 100% for all the renewable technologies, but capacity and availability constraints are applied to reflect resource and engineering potentials (see Table 6 in section 2.1.8). The following sections describe the renewable technologies in detail.

¹⁴ Average of the five nuclear plants in the model. See Appendix for individual plant availability factors.

Solar Photovoltaic (PV)

Monthly and hourly solar irradiances were analyzed for selected locations from each country, for a tilt angle of 35 degrees from the azimuth (JRC 2013). The hourly and monthly availabilities are normalized to annual capacity factors for solar PV, and the hourly capacity factors are implemented as hourly availability factors. An example for Germany is shown in Figure 15 (see Appendix A for other locations).

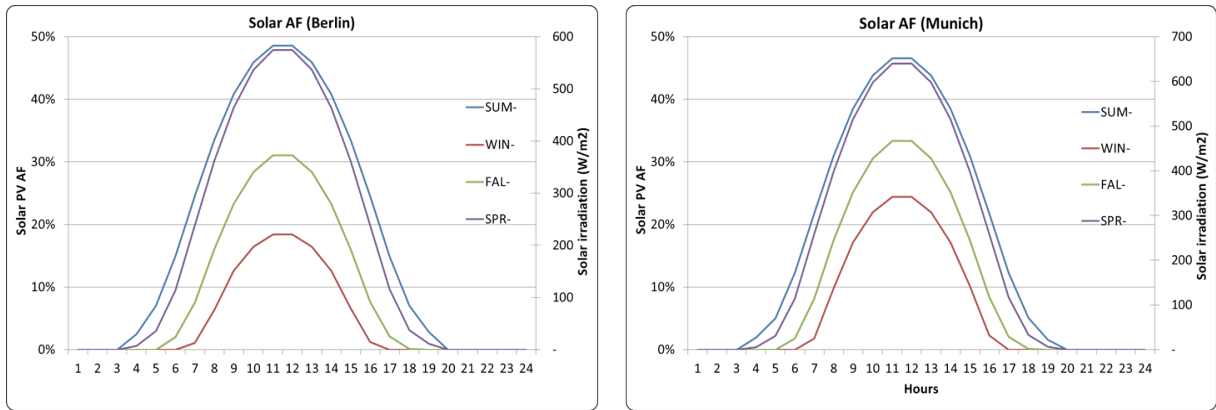

Figure 15: Hourly solar irradiation and solar PV availability factors (Berlin & Munich, Germany)

Wind Energy

Hourly wind based electricity generation profiles from all the countries, for the years 2010-2013 were used to estimate the aggregated hourly capacity factors, and were implemented as hourly availability factors in the model. An example of the wind profile for Austria (Austrian Power Grid 2014) is given in Figure 16. It can be seen that the wind based electricity generation is usually higher during the night time than during the day. One can also notice seasonal variability, with the availabilities generally lowest during the summer. It is important to note that the wind turbines are not forced to follow this wind profile. Instead, the maximum output from wind turbines is restricted by the availability factor. Thus, the model could curtail generation from wind turbines in order to balance electricity supply and demand.

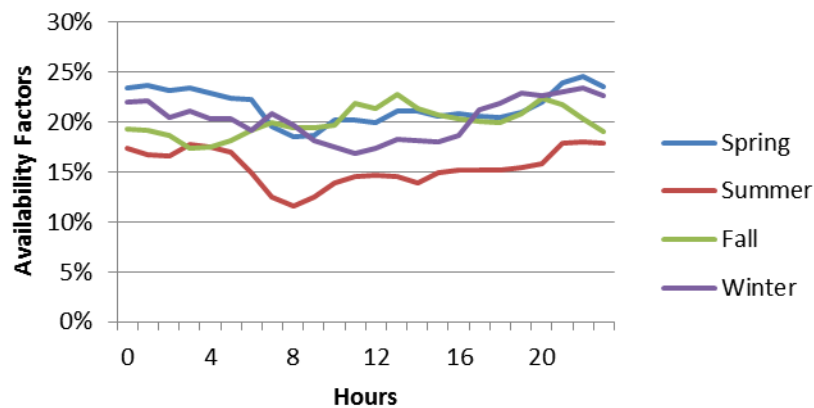

Figure 16: Availability factors for wind turbines (Austria)

Others

Geothermal, tidal and concentrated solar power (CSP) plants are characterized as seasonal base-load plants. Biomass, wood and waste incinerators are characterized as base-load plants. Although these existing plants are mainly CHP, we modeled them as electricity plants (since CROSSTEM does not cover the heat sector). Since total installed capacity of CHP is relatively low (for example in Switzerland, CHP accounts for less than 3% of the total electricity generation capacity), this assumption is not significant.

2.1.7.6 New and future technologies

A range of new and future technologies have been included to supplement the existing technologies. All existing technology categories are included for future technologies. In addition, some newer technologies such as Carbon Capture and Storage (CCS) and Solar CSP are also introduced. The techno-economic characteristics of the new technologies are given in Table 5, page 41. The technologies also have a learning curve with vintages, reflecting capital cost reduction and efficiency improvements over time. Figure 17 shows capital cost reduction for selected renewable technologies. For large scale power plants, construction times are included to factor in lead times and interest costs during construction. Similarly, decommissioning time and costs are also incorporated. Most of the technical and cost data for the new technologies are adopted from estimates by the PSI Technology Assessment group (Paul Scherrer Institute 2010), with other sources (IRENA 2012; Lako 2010; Resch et al. 2006; Schröder et al. 2013) used for updates and cost comparisons. It is worth noting that CROSSTEM is a spatially aggregated model and therefore the interconnectors between the regions and transmission and distribution networks within each region are not explicitly modeled. However, to account for these capacities, an ad-hoc interconnector and T&D grid is included with a simplified cost function. Investment costs of interconnectors were taken from Odenberger/Unger 2011, while their O&M costs were based on Swissgrid network usage charges.

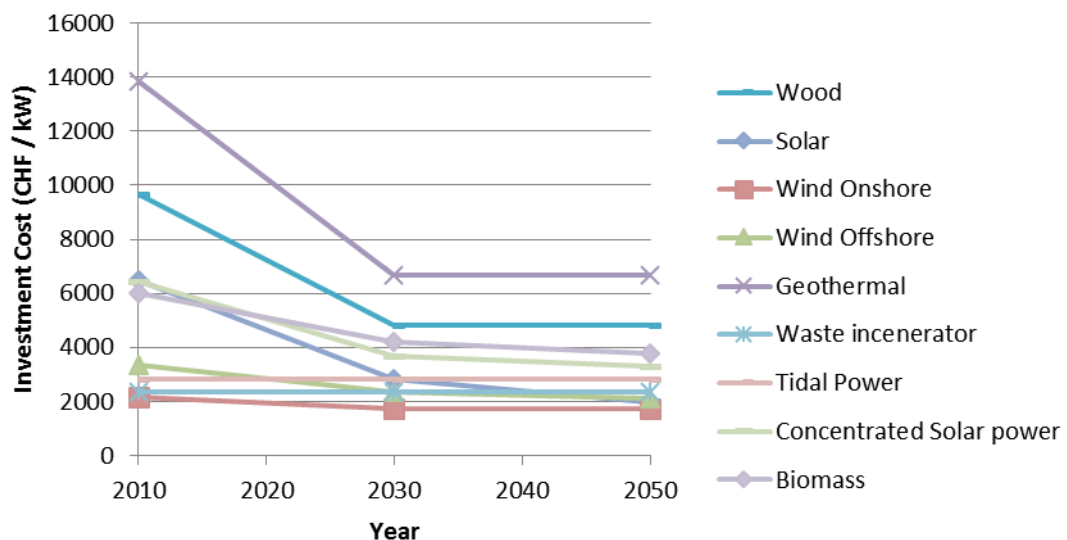

Figure 17: Investment costs of renewable technologies

Table 5: Technical characteristics and cost of new technologies

Technology Description	Vintage Year	Life time (year)	Eff (%)	AF+ (%)	Capital Cost (CHF/kW)	FOM Cost (CHF/kW/year)	VOM Cost (CHF/GJ)	Lead time (year)
Hydro (River)	2015	80	80%	63%	6'560	18.2	1.67	3
Hydro (Dam)	2015	80	80%	27%	10'000	9.7	1.84	3
	2030	80	80%	27%	8'000	9.7	1.84	3
Nuclear: Gen2 (LWR) Gen3 (EPR) Gen4 (FBR)	2010	50	32%	80%	4'250	22.5	3.25	6
	2030	60	35%	80%	4'250	11.6	1.92	6
	2050	40	40%	80%	4'750	55.1	0.18	6
Coal: SCPC*	2010	30	43%	80%	2'350	40.3	0.69	3
	2030	35	50%	87%	2'150	45.1	0.79	3
	2050	35	54%	87%	2'050	45.1	0.79	3
Coal: SCPC with CCS	2030	35	43%	87%	3'200	69.3	0.92	3
	2050	35	49%	87%	2'900	69.3	0.92	3
Lignite [§] : SCPC	2010	40	40%	86%	2'450	52.0	0.69	3
	2030	40	43%	86%	2'241	58.2	0.79	3
	2050	40	49%	86%	2'137	58.2	0.79	3
Lignite [§] : SCPC with CCS	2030	40	33%	86%	4'480	95.0	0.92	3
	2050	40	41%	86%	4'060	95.0	0.92	3
Natural Gas: GTCC# Base load	2010	25	58%	82%	1'150	7.8	6.72	3
	2030	25	63%	82%	1'050	7.8	6.72	3
	2050	25	65%	82%	1'050	7.8	6.72	3
Natural Gas: GTCC with CCS	2030	25	56%	82%	1'700	15.6	13.44	3
	2050	25	61%	82%	1'500	15.6	13.44	3
Solar: PV	2010	40	100%	11%	6'500	5	1	0
	2030	40	100%	11%	2'850	5	1	0
	2050	35	100%	11%	1'950	5	1	0
Wind: Onshore	2010	20	100%	14%	2'150	44	14	0
	2030	20	100%	14%	1'750	28	9	0
	2050	20	100%	14%	1'750	28	9	0
Wind: Offshore ^β	2010	20	100%	44%	3'350	87	9	2
	2030	20	100%	44%	2'350	58	6	2
	2050	30	100%	48%	2'100	22	14	2
Geothermal	2020	30	100%	80%	13'825	134	12	3
	2030	30	100%	80%	6'650	87	29	3
Waste Incinerator	2020	30	15%	15%	2'350	40	1	3
Pump hydro	2010	80	80%	27%	7'000	10	2	3
Tidal Power plant [^]	2010	25	100%	30%	2'850	49	-	3
Solar: CSP ^{&}	2010	25	100%	33%	6'449	65	2	3
	2030	25	100%	33%	3'702	65	2	3
	2050	25	100%	33%	3'295	65	2	3
Interconnector	2010	50	100%	90%	434	1.2	0.4	0

+ All renewable availability factors given in this table are for Switzerland. AFs vary across different regions, especially those for renewable technologies, as detailed in the appendix.

* Supercritical pulverized coal.

§ Technology only available in Germany.

Gas turbine combined cycle – The data given is for base-load plants. For flexible gas plants (merit order), the same cost numbers have been used, but a 20% penalty is applied to efficiency and availability factor to account for interrupted operation.

β Technology only available for Germany, France, and Italy.

& Technology only available for Italy.

^ Technology only available in Italy, France.

Non-fossil fuels, including electricity imported from fringe countries¹⁵ are assumed to be carbon free. Carbon capture and storage (CCS) technologies are assumed to have a capture efficiency of 90% and to be available from 2030 onwards. A capacity reserve margin of 30% is assumed throughout the model horizon, and all technologies with the exception of wind and solar technologies contribute to the reserve calculation. Transmission and distribution losses of 5-7% are assumed based on historical values of each country.

2.1.8 Energy resources

Energy resources are modeled in three broad categories viz. imports (which include all fuels as well as electricity import), exports (electricity exports) and renewables (all renewables resources, including hydro). Energy resources are characterized with resource availability and cost. There are no specific resource constraints for the fossil fuels, and their cost numbers are adopted from the World Energy Outlook 2010 (IEA 2010). Cost of uranium fuel rods for nuclear power plants are adopted from Paul Scherrer Institute 2010 (see Figure 18).

Renewable resource potentials implemented in CROSSTEM are based on various national and EU-wide studies (Akademien der Wissenschaften Schweiz 2012; BMLFUW 2009; Chamorro et al. 2014; Ess et al. 2012; European Commission 2013; Kannan/Turton 2011; Beurskens et al. 2011; Lako 2010; Lanati/Gelmini 2011; DLR et al. 2012; Resch et al. 2006; Réseau de transport d'électricité 2012). The potentials are linearly interpolated from the actual deployment in 2010 to the 2050 values. There are high uncertainties regarding the renewable resource potentials, and it is an area for parametric sensitivity analysis, such as scenarios enabling an early uptake of the full renewable potential (which would make sense for a stringent climate target scenario).

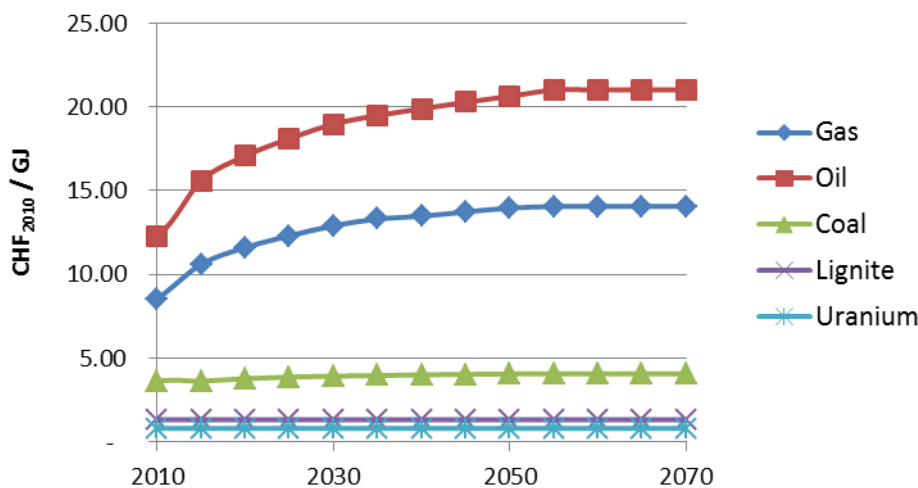

Figure 18: Fuel costs – WEO 2010

¹⁵ Fringe countries are the countries surrounding the five regions in CROSSTEM. They are modeled as one external region, with the imports and exports between a CROSSTEM region and fringe region being limited to historical upper limits on an annual basis.

Table 6: Renewable resource potentials

Energy resource	Resource potentials (2050) (PJ _{elec})				
	AT	CH	DE	FR	IT
Waste & biogas	3	8.1	21	16	18
Biomass (wood)	23	13	191	65	76
Solar PV	11	36	230	159	288
Solar CSP	-	-	-	-	29
Wind (onshore)	25	14	475	234.8	64
Wind (offshore)	-	-	461	332.2	129
Geothermal	1	16	69	5	57
Hydro (reservoir)	31	75	3.6	131	50
Hydro (run of river)	117	58	86	117	145
Tidal power	-	-	-	5.2	0.03

2.1.9 Electricity trade

As a multi-region model, CROSSTEM has the option to trade electricity endogenously between the five countries based on their marginal generation costs. In addition, the model has the option to trade with the external fringe region as well. The model has the possibility to invest into new interconnector capacities. CROSSTEM is allowed full freedom with respect to the timing of the imports and exports at the time slice levels. However, constraints are applied at annual levels to keep historical trends in electricity trade. For example, Italy and Austria are traditionally net importers of electricity while France, Switzerland and Germany are net exporters. For the scenarios analyzed in section 2.1.11.1, these boundary conditions on trade are not allowed to change, i.e. net exporting countries cannot become net importers in the future and vice versa¹⁶. To avoid excessive import to circumvent stringent low carbon scenarios, net trade with the external fringe region is also bounded to the historical maxima. Import/export prices with the fringe region have been adopted from the ADAM project (Tyndall Centre for Climate Change Research 2010; Kannan/Turton 2012). An example is shown in Figure 19, which shows the exogenous import/export prices for fringe regions in the year 2050.

Table 7: Electricity trade matrix

Trade	CH	AT	FR	DE	IT	OT*
CH						
AT						
FR						
DE						
IT						
OT*						

* Denoting Fringe (external) region
 Interconnector available
 Interconnector unavailable

¹⁶ The trade constraints are introduced to prevent the model making investments in just one country and all other countries importing from that country.

The CROSSTEM countries can only trade with their adjacent neighbours, as shown in the matrix in Table 7. The interconnectors are assumed to have no energy loss and an annual availability of 90%, to account for annual maintenance (own assumption).

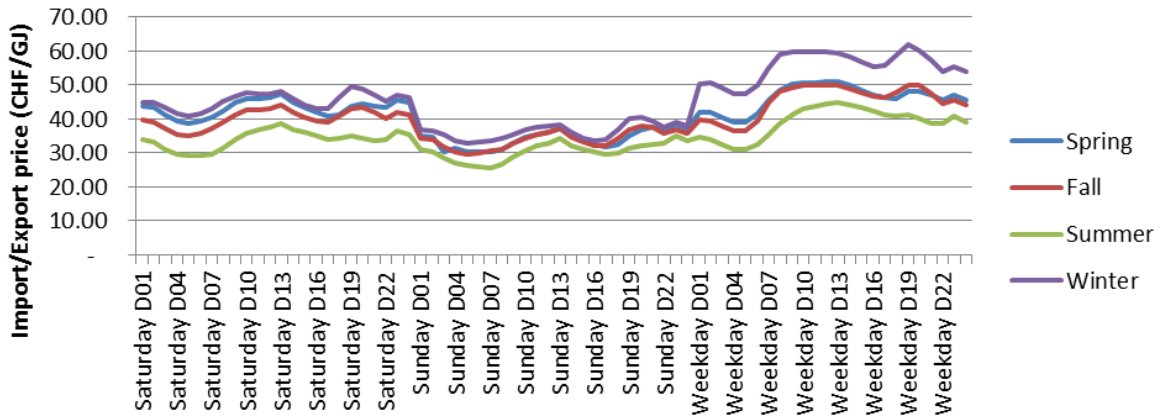

Figure 19: Electricity trade prices to and from fringe regions in 2050

2.1.10 Carbon dioxide emissions

Carbon dioxide (CO₂) emissions from fossil fuels are traced at the resource consumption level, with CO₂ emission factors assigned to each fuel type given in Table 8. Non-fossil fuels, including imported electricity from fringe countries are assumed to be carbon-free. A CO₂ emissions tax is applied based on the Emission Trading Scheme (ETS) price assumptions from the Energy Perspectives 2050 (Prognos 2012), and ranges from 15 CHF/t CO₂ in 2010 to 57 CHF/t CO₂ by 2050.

Table 8: CO₂ emission factors

Energy commodity	CO ₂ emission (t/TJ)
Lignite	116
Coal	91
Oil	78
Gas	56

2.1.11 Application of the CROSSTEM model

In this section, some illustrative results are presented to demonstrate the features and capabilities of the CROSSTEM model and highlighting its advantages over the single region STEM-E model (also referred to as the CROSSTEM-CH model¹⁷). A set of scenarios with different boundary conditions on electricity trade and technology development in Switzerland and the neighbouring countries are defined and analyzed here.

¹⁷ CROSSTEM-CH is the Swiss module of the CROSSTEM model, where trade with the neighbouring countries is exogenous.

2.1.11.1 Scenario overview

Three electricity supply scenarios have been analyzed in this section using the *weiter wie bisher* electricity demand of the Swiss Energy Strategy 2050. The scenarios are consistent with earlier studies analyzed using the STEM-E model (Paul Scherrer Institute 2012). However, with the CROSSTEM model, we have an improved framework that better represents international boundary conditions regarding source of electricity import and market for electricity export based on marginal costs of electricity generation in the neighbouring countries. The three scenarios comprise of a common set of assumptions and scenario specific boundary conditions, which are chosen to generate insights on the influences of policies in the neighbouring countries on the Swiss electricity system. Figure 20 provides an overview of the scenarios. Assumptions common to all scenarios include:

- Electricity demand: Swiss demand is adopted from the *weiter wie bisher* scenario in the Energy Perspectives 2050 (Prognos 2012), and neighbouring countries' demands are taken from the EU Trends to 2050 study (European Commission 2013)(See section 2.1.6.).
- Nuclear power: phase-out of existing nuclear plants in Switzerland and Germany, no new investments in nuclear technology except in France, where maximum new investment is capped to 2010 installed capacity.
- Coal power: No investment in coal power is allowed in Switzerland. For neighbouring countries, a growth constraint is applied for new investments in coal and lignite¹⁸ fired power plants based on the coal capacity in the last 5 years, to prevent unrealistic capacity expansions in coal based power plants.
- Electricity import/export: Traditional net importers of electricity (i.e. Italy and Austria) cannot become net exporters and traditional net exporters (France and Germany) cannot become net importers. These market/boundary conditions are very crucial assumptions, and small changes to these conditions would significantly affect the results. At the same time, it is also a strength of CROSSTEM that different boundary conditions can be analyzed under a what-if framework.
- International energy and CO₂ price assumptions: As described in sections 2.1.7 and 2.1.10 respectively.

Scenario 1 (Sc1)

This scenario can be described as a business as usual scenario without any carbon constraints, and is comparable to the *Gas* scenario in Energie Spiegel 21 (Paul Scherrer Institute 2012), i.e. Switzerland has the option to build gas power plants while the neighbouring countries have a much wider range of electricity supply sources. *Sc1* directly corresponds to the *Baseline* scenario in the coupled framework (see sections 1.4.1 and 3.1.3.1). Switzerland is assumed to be self-sufficient in supply over the year, i.e. we do not allow net electricity imports/exports.

¹⁸ Available for Germany only.

	Framework →		Coupled framework (GENISwIS + CROSSTEM-CH)#			CROSSTEM##		
	Scenario name		Baseline	TAX	NoGAS (imports)	Sc.1	Sc.2	Sc.3
	Scenario description		Baseline	TAX	NoGAS (imports)	Baseline	Baseline —LC _{EU}	Baseline NoGas —LC _{EU}
Switzerland	Electricity demand		WWB	WWB*	WWB*	WWB	WWB	WWB
	Electricity supply variants	Gas plants	Yes	Yes	No	Yes	Yes	No
		Imports	No (S.S)	No (S.S)	Yes**	No (S.S)	No (S.S)	Yes**
	CO ₂ cap		No	No	No***	No	No	Yes [^]
EU boundary	Electricity demand		Not applicable (electricity import/export price are exogenously given)			WWB	WWB	WWB
	CO ₂ cap					No	Yes (95% by 2050) [^]	Yes (95% by 2050) [^]

Only the CH region of CROSSTEM is coupled and the other regions (neighbouring countries) are turned off.

Endogenous trade among the regions is enabled (but not coupled with GENESwIS).

* Converged demand differs from WWB.

** Import is allowed up to an equivalent gas-based supply from the Baseline.

*** An indirect cap applies, because gas plants are restricted.

[^] Applied on all 5 countries together.

S.S - Self-sufficiency constraint for CH.

Sc.1 → Sc.2, price of imported electricity is expensive, because the EU shifts towards low carbon/clean sources of electricity.

Sc.2 → Sc.3, CH does not have cheap electricity from gas and relies on imported electricity to meet the demand.

CO₂ price – EU ETS prices as given in WWB, for all scenarios.

Figure 20: CROSSTEM scenario matrix

Scenario 2 (Sc2)

This scenario is a variant of Sc1, where a decarbonization of the entire power sector is envisaged in Switzerland and the neighbouring countries. The CO₂ emissions from all the five CROSSTEM countries are to be reduced by 95% of 1990 levels (or about 94% of 2010 levels) by 2050. Note that the **CO₂ cap is applied across all five regions** in the model and is not country specific. Thus the model identifies least cost sources of low carbon electricity supply subjected to the technical, resources and trade constraints. This scenario highlights the influence of the neighbouring countries' electricity system on electricity supply and operational patterns.

Scenario 3 (Sc3)

This scenario is the same as the Sc2 scenario, with an additional constraint included in Switzerland that **restricts investment in new gas power plants**. Since the assumed renewable resource potential in Switzerland is not adequate to meet its electricity demand, the self-sufficiency constraint has been relaxed so that Switzerland can become a **net importer of electricity**. However, the level of net electricity imports is limited to the level (in PJ) of gas imports in the TAX scenario of the coupled framework (see section 1.4.1, Figure A 28 in Appendix A), to prevent exorbitant imports of electricity from other regions. It is worth noting that relaxing the self-sufficiency constraint enables the model to import cheap electricity from the neighbouring countries, if cost effective. This scenario is analogous to the NoGAS scenario in the coupled framework.

2.1.11.2 Results

This section details the results of the CROSSTEM scenarios described above. The results discussed here mainly focus on Switzerland, with results of the neighbouring countries given in Appendix B. In section 2.1.12, results from the CROSSTEM model are compared to results from the single region CROSSTEM-CH model to highlight the benefits from the new framework.

2.1.11.2.1 Electricity generation mix

The Swiss electricity generation mix and installed capacity for the three scenarios are given in Figure 21 and Figure 22, respectively. In the Sc1 scenario, new gas power plants (both base-load and flexible plants) gradually replace the existing nuclear plants. By 2020, 365 MW of nuclear capacity is retired (Mühleberg in 2019), while the electricity demand increases by 5%. In this time, the model invests in around 1.9 GW of base load type natural gas generation capacity. By 2035, the remaining nuclear capacity¹⁹ is replaced by a combination of base-load (4.2 GW) and flexible (3.2 GW) gas power plants. The flexible gas generation capacity enables better supply-demand balancing in conjunction with the imports/exports from the neighbouring countries, which also enables Switzerland to generate more trade revenue by exporting more electricity during peak hours (see section 2.1.11.2.2). By 2050, 51% of the generated electricity is from hydro, 46% from gas power plants and the remaining 3% from new renewables (primarily waste and biogas).

In Sc2, the electricity generation mix in the near term (2020) appears identical to that in Sc1, but the total installed capacity of gas plants is 3 GW compared to 1.9 GW in Sc1. The higher installed capacity is because of the higher costs of imported electricity in Sc2, especially in winter due to the CO₂ constraints. I.e. sources of zero carbon electricity in winter are limited partly due to expensive renewable technology costs during the earlier periods. Hence the model minimizes imports during certain hours (see section 2.1.11.2.2) by generating more electricity locally, especially in winter, which in turn reduces the total capacity factor of the gas plants. By 2035, investments in gas CCS (carbon capture and storage) as well as wind technology are required to comply with the CO₂ emission cap. By 2050, all thermal power is produced by gas CCS power plants (3.1 GW, 29% of total generation), while solar PV, wind and other renewables contribute to around 20% of the generation mix. Investments in renewable technologies are required due to the CO₂ emission cap as well as the

¹⁹ Although the last nuclear power plant in Switzerland (KKW Leibstadt) goes offline in 2034, 2035 still shows that 2.5% of the total electricity generation comes from nuclear. This is because the milestone year displays an average of all the years within that time period.

self-sufficiency constraint. The emission cap prevents more investments in gas CCS plants due to residual emissions (CCS plants capture only 90% of the total emissions), while the self-sufficiency constraint prevents the import of cheap electricity from the neighbouring countries. The higher cost of electricity also means a reduced pumped hydro usage compared to Sc1, due to the associated energy losses in pumped hydro.

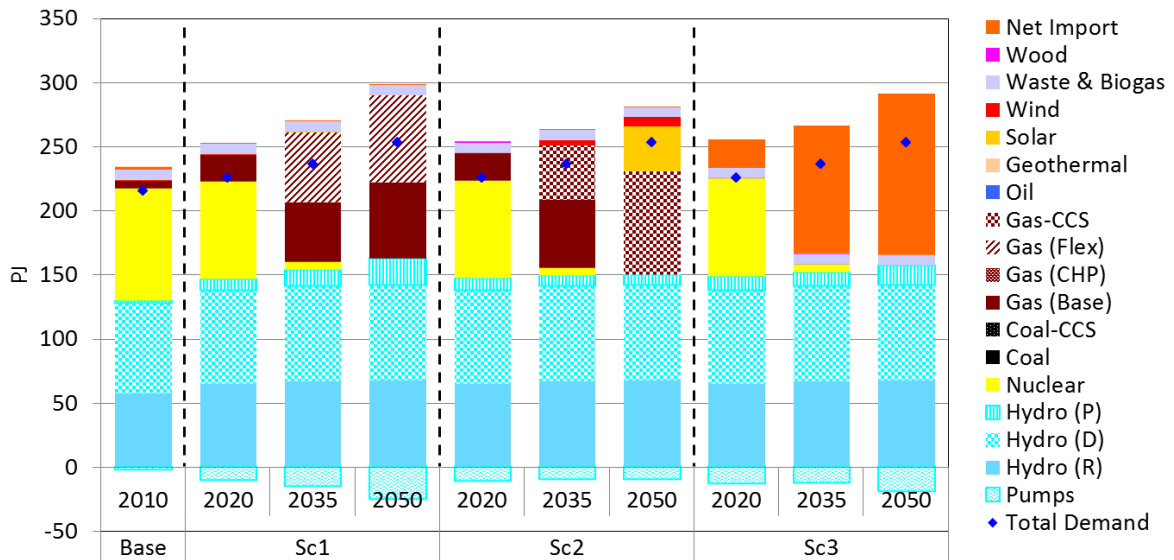

Figure 21: Electricity generation mix (Switzerland)

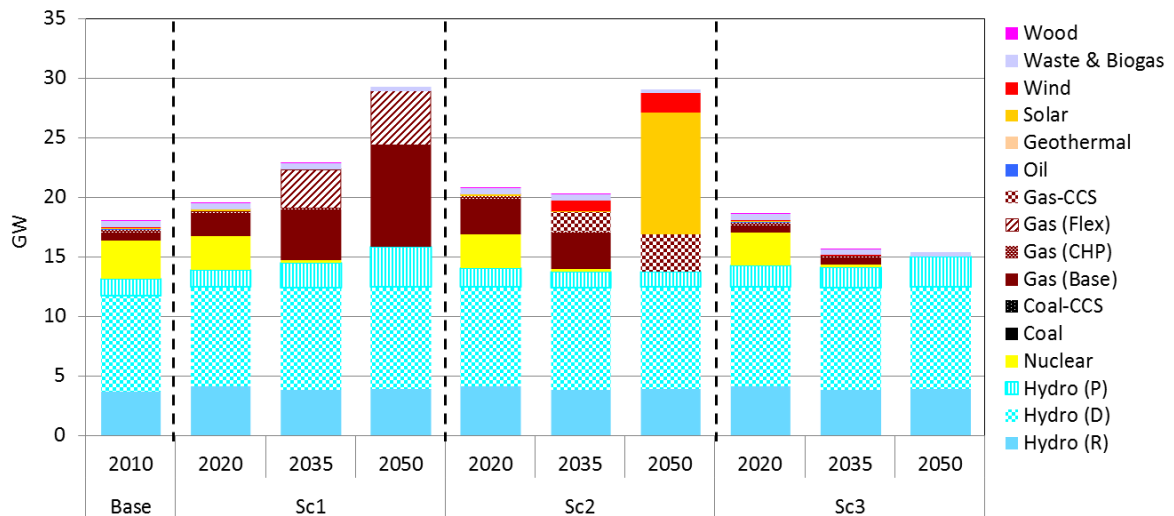

Figure 22: Installed capacity (Switzerland)

In Sc3, with the restriction on investments in gas plants and the relaxation of the self-sufficiency constraint, the cost optimal option for Switzerland is to replace the existing nuclear capacity with imported electricity. By 2035, almost 40% of the electricity demand is imported, and by 2050 the share of imported electricity increases to 46%. By relaxing the self-sufficiency constraint, Switzerland is able to let the neighbouring countries invest in cheaper technologies and import the electricity, rather than having to build expensive gas CCS plants or renewables which have less favourable conditions (e.g. lower capacity factors for renewables) in Switzerland. Where this additional investment is made is shown in Figure 23.

The figure shows the relative shares in the electricity generation mix for the five countries in the base year (2010) and in the year 2050 for all three scenarios. Since the boundary conditions for the neighbouring countries are identical for both Sc2 and Sc3, the difference in the electricity generation mix between these two scenarios is caused by the relaxation of the self-sufficiency constraint in Switzerland. It is observed that for Italy, Austria and Germany, there are no visible variations in the electricity generation mix between the two scenarios. France on the other hand has an increased share of renewables in Sc3 compared to Sc2. As the total installed capacity and production from nuclear and hydro plants in France is constant across three scenarios (see Figure B 1 and Figure B 2 in Appendix B), the increasing share of renewables shown in Figure 23 means an increase in the installed capacity of renewables. In fact, France invests in an extra 15 GW of wind capacity and 2 GW of solar PV capacity. Both wind and solar PV are more cost competitive than gas CCS plants by 2050, which prompts Switzerland to import the cheaper electricity from France. At the same time, France has to invest in higher renewable capacity, but generates additional trade revenue by exporting the electricity to Switzerland (see section Figure B 3 in Appendix B). It is worth recalling that due to the trade constraints (see 2.1.11.1), only France and Germany can be net exporters, which limits other regions from investing in higher renewable capacities. It is also important to note that the 'no gas plants' constraint is not affecting the results for Switzerland (the constraint is loose) and the relaxation of the self-sufficiency constraint is enough to obtain the results discussed above. This indicates that the limits on net imports is quite generous (120 PJ in 2050, see Figure A 28 in Appendix A), as there is still unexploited renewable potential in Switzerland. Nonetheless, the restriction on gas plants is still applied to be consistent with the coupled framework scenarios (*NoGas*, see section 1.4.1).

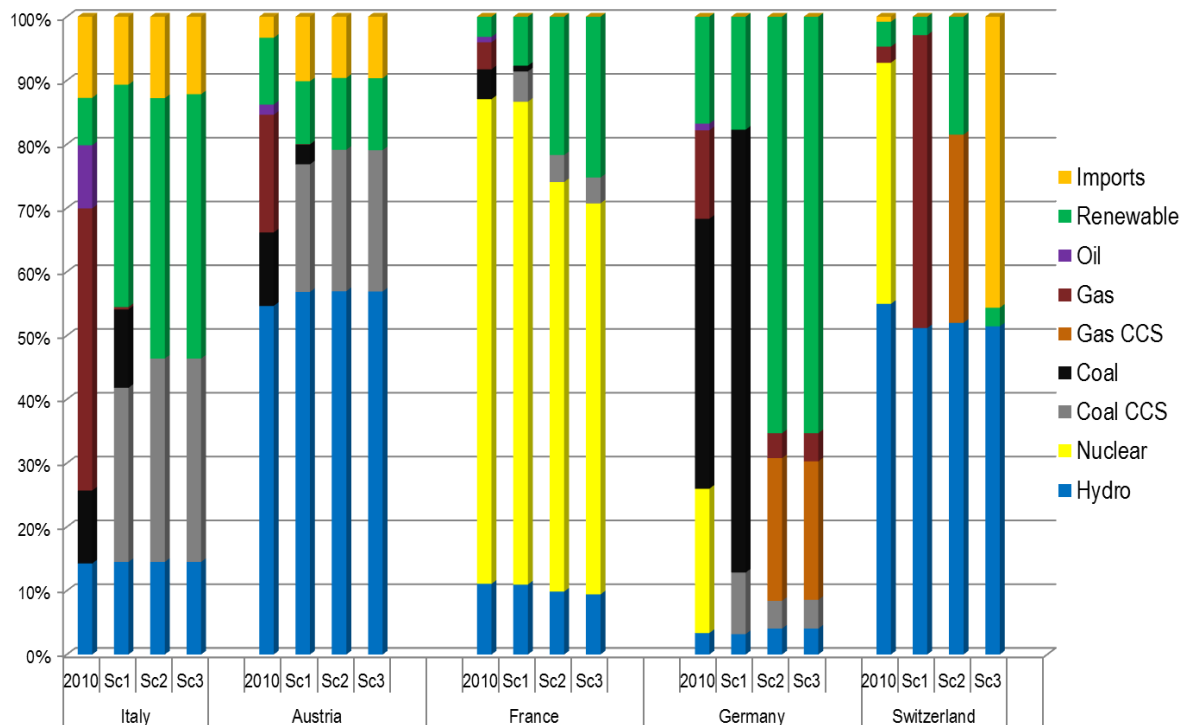

Figure 23: Electricity generation mix of CROSSTEM countries (2050)

2.1.11.2.2 Generation schedule

One of the main features of the CROSSTEM model is its ability to depict hourly electricity load patterns. The hourly supply and demand balance curves of Switzerland for a winter weekday in 2050 for all three scenarios are shown in Figure 24. The supply profile of other seasons and days are given in Appendix C. In the figure, electricity demand (blue line) and supply mix are shown in the upper panel, while the lower panel depicts electricity export (grey shade), and consumption by pumped hydro (light blue shade). The red line in the upper panel is the marginal cost of electricity supply. Unlike dispatch-type models, the marginal cost from CROSSTEM is not the short-run marginal cost of generation, but the long-run marginal cost of electricity by accounting for required capacity.

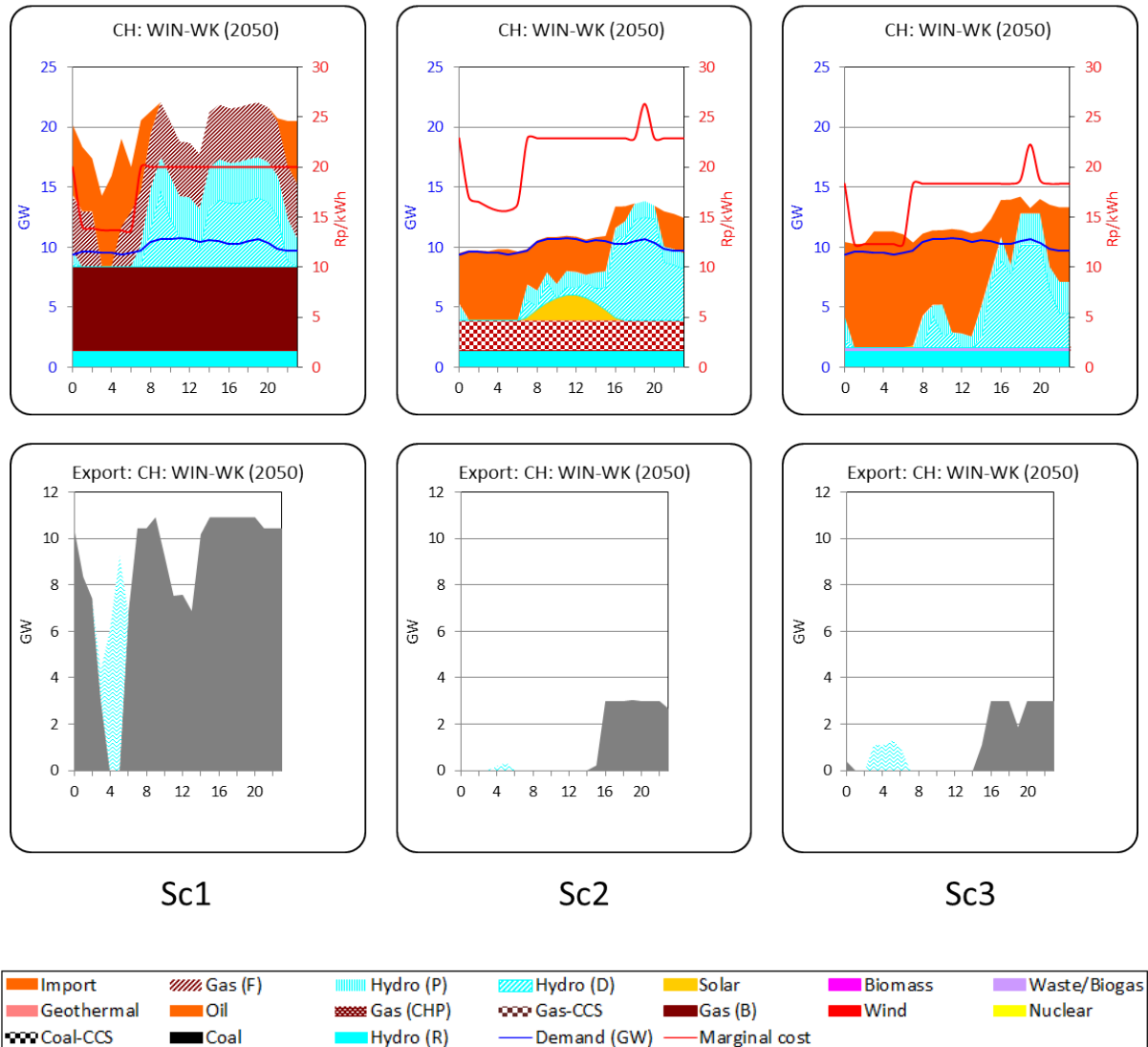

Figure 24: Electricity generation schedule of Switzerland on a winter weekday in 2050

In Sc1, electricity supply from base load generation plants (natural gas and river hydro) covers almost 84% of the demand. The rest of the demand is met with a combination of imported electricity (during early morning hours 00:00-08:00) and flexible gas and dam hydro plants (scheduled during 08:00-22:00). Some of the imports are stored via pumped hydro during 03:00-05:00. The surplus electricity production from the gas and hydro plants is exported. In addition, the pumped hydro is also scheduled during 8:00-22:00 and exported.

In *Sc2*, due to the CO₂ constraint, Switzerland does not have similar levels of base load capacities as for *Sc1*, with only around 39% of the demand covered by base load gas CCS plants and river hydro (vs. 84% in *Sc1*). There is a higher reliance on imported electricity throughout the day, with solar PV and dam/pumped hydro plants reducing the level of imports during peak hours (08:00 – 00:00). Exports in winter are greatly reduced in this scenario compared to *Sc1*. The source of electricity import and market for the export for *Sc2* is further elaborated in section 2.1.11.2.3 below.

In *Sc3*, in the absence of gas plants (due to the constraint) and renewable technologies (due to high costs compared to imported electricity), electricity imports are required throughout the day, with only 16% of the demand covered by base-load river hydro plants. As observed with *Sc2*, flexible hydro plants are scheduled during peak hours to reduce imports. A part of the outputs from dam/pumped hydro is also exported from 16:00-00:00.

While comparing the marginal costs in Figure 24, *Sc2* displays the highest marginal costs amongst the three scenarios. This is due to a combination of the CO₂ emissions cap which increases cost of imported electricity compared to *Sc1*, and the self-sufficiency constraint which forces investments in expensive gas CCS technology. The latter is inferred from insights obtained from *Sc3*. Surprisingly, *Sc3* has the lowest marginal costs – even lower than the *Sc1* scenario which does not have any CO₂ emission constraints. This indicates that Switzerland has to pay a high cost for the gas based generation to fulfil the self-sufficiency constraint. Otherwise, cheaper import options are available elsewhere in the neighbouring countries.

2.1.11.2.3 Electricity trade – source of import and market for export

As will be explained in section 2.1.12, one of the main advantages of CROSSTEM over a single region electricity model is that the trade is endogenous and based on marginal cost of generation. This means that in order to import electricity in one region, there has to be a surplus electricity generation in at least one of the other regions. Hence in CROSSTEM the source of electricity import and market for export can be traced to understand the underlying drivers. To illustrate this, Figure 25 shows electricity generation schedule on a winter weekday in 2050 for *Sc2*, for all five countries with their source of import and market for export. The top panel shows the electricity generation schedule while the middle and lower panels show countries from/to which electricity is imported/exported.

We start with the generation schedule for Switzerland, which has already been described above (see Figure 24). Electricity is imported almost throughout the day. The majority of the imports are coming from Germany, with minor supply from France, Italy and Austria during the early morning hours (00:00-07:00). Switzerland exports electricity during the evening hours (16:00-00:00) to Italy.

The German electricity schedule shows that there is indeed overproduction of electricity throughout the day from its large wind and thermal base-load capacity. This is further supplemented by solar PV during the day time, with flexible hydro dispatched during evening hours. Electricity is imported only for a few hours in the evening (18:00-20:00), with imports coming from France. Exports are primarily to Switzerland, Austria, France and the fringe (Other) regions.

In France, the demand is fully covered by a combination of nuclear, river hydro, coal CCS and waste/biogas based electricity generation. Solar PV and dam hydro complement these base-load plants, resulting in continuous exports throughout the day, primarily to Italy.

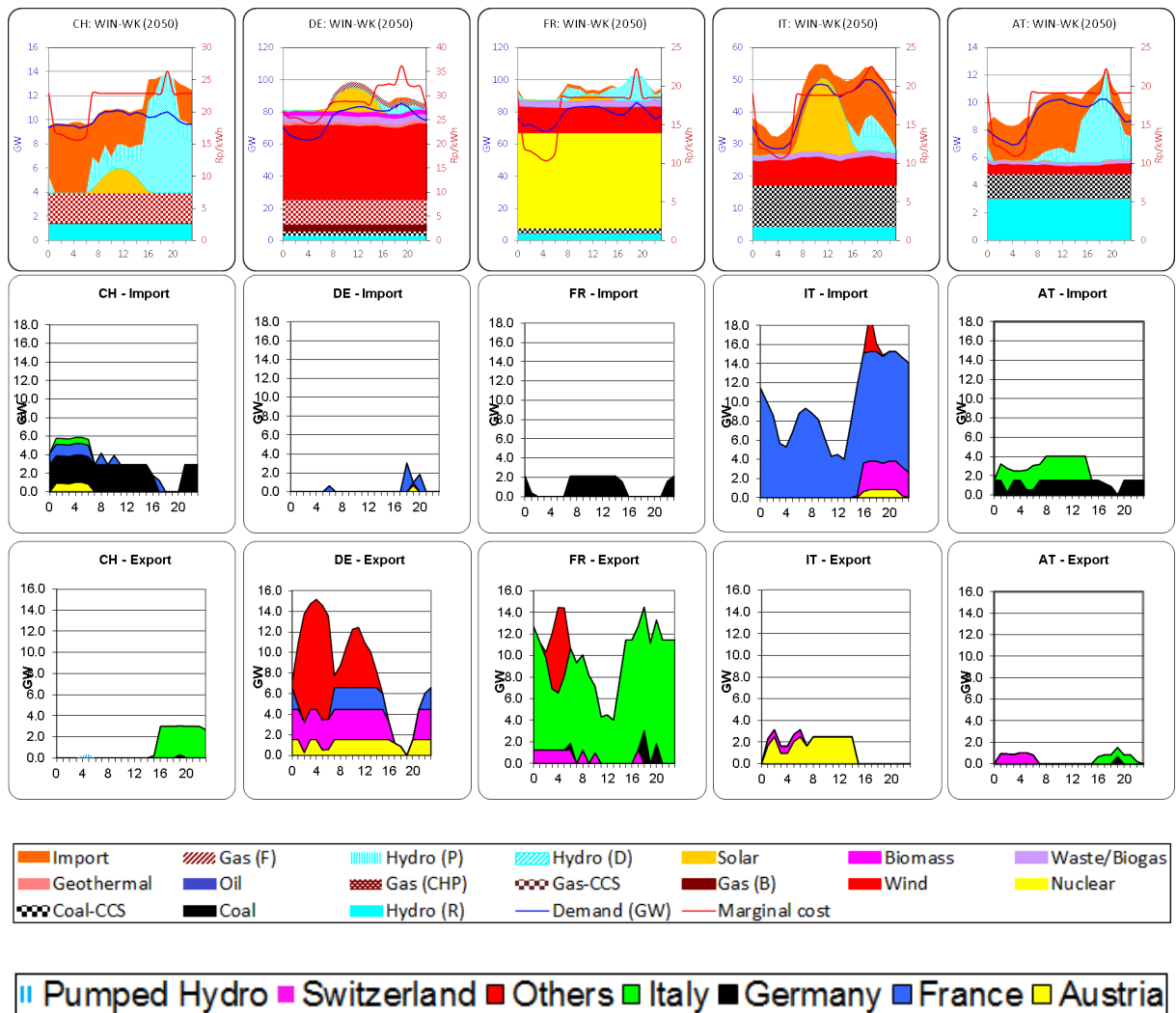

Figure 25: Electricity generation schedules for all countries on winter weekday 2050 (Sc2)

Italy has a high investment in solar PV due to its high availability factor in the region, which is supplemented by wind, coal CCS, waste/biogas and river hydro based generation. However, total supply from these sources is lower than the demand and therefore imports are required throughout the day. Most of the imports come from France. The output from solar PV is favorable to the step increase in demand during daytime. In the evening (17:00-00:00), flexible hydro plants are scheduled to manage the second peak in demand. However, Italy still requires substantial imports to meet the evening peak demand and the imported electricity is supplied from France, Austria and Switzerland. Italy also imports more than its demand during 01:00-14:00 from France, which is eventually exported to Austria during the first half of the day (01:00-14:00).

Austria has a profile similar to Switzerland. Imports are happening throughout the day, coming mainly from Italy and Switzerland, with the flexible hydro plants dispatched during the evening hours to reduce imports at peak price hours.

Similar electricity generation schedules for the other scenarios, other seasons and other days of the week are given in Appendix C.

2.1.11.2.4 Cost of electricity supply

Figure 26 shows the annual undiscounted electricity system costs for Switzerland for the three scenarios. The costs are broken down to various cost components such as capital costs (annuities on investments), taxes (levy on nuclear spent fuel and CO₂), fixed and variable operation and maintenance costs, fuel costs and trade balances, which refer to net profits if negative or cost if positive from electricity import or export. The net system cost is also shown in Figure 26 (blue marker).

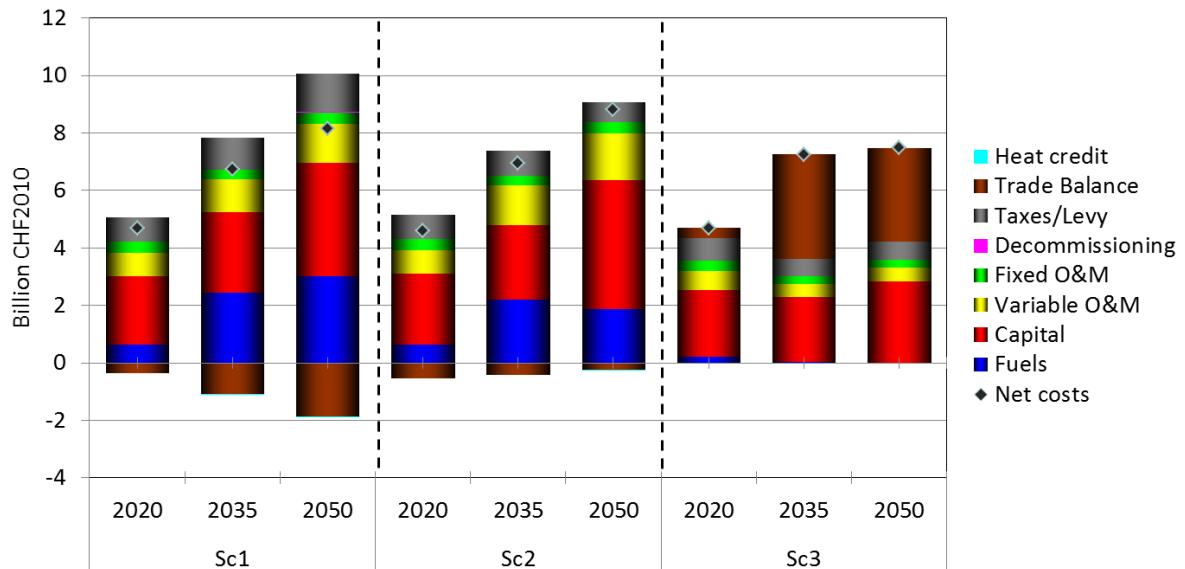

Figure 26: Undiscounted system costs (Switzerland)

The electricity system cost increases from 2010 to 2050 in all three scenarios in line with the electricity demand assumption (Figure 10). For *Sc1*, in the near to long term (2020-2050) the main increase is in capital and fuel cost due to the investment and operation of new natural gas power plants. The higher share of gas based generation (Figure 21) as well as increasing natural gas price assumptions (Figure 18) increase the total cost of fuel in the energy system. The increasing CO₂ emissions (see Figure 29, page 55) result in an increase in tax payments (CO₂ taxes). At the same time, the relatively high quantity of electricity trade (see Figure 24) generates surplus revenue. Nevertheless, the total system cost increases.

In *Sc2*, the generation mix in the near term is similar to *Sc1* resulting in similar costs. By 2035 however, the ‘total’ cost is slightly lower in *Sc2* compared to the *Sc1* scenario. Relatively lower installed capacity (see Figure 22) in gas based generation results in a decrease in capital and fuel costs, as well as CO₂ taxes. However, the level of the capital cost component is similar to the *Sc1* scenario, because (see Figure 27) *Sc2* requires capital intensive technologies like gas CCS plants, solar PV and wind turbines (Figure 22). By 2050, investments in renewables technologies (solar PV and wind) increase the capital costs further, but the fuel costs and CO₂ taxes reduce due to lower gas CCS based electricity generation (see Figure 22). Although the ‘total’ system costs are lower in *Sc2* compared to *Sc1* for years 2035 and 2050, the ‘net’ system costs (obtained by subtracting the surplus trade revenues from total system cost) are higher in *Sc2* due to lower trade revenue. This is because average cost of electricity supply is expensive in Switzerland compared to other CROSSTEM countries in *Sc2*, making it less attractive for other countries to import from Switzerland, thereby reducing the trade revenue. Figure 28 shows the average cost of electricity *Sc2* and *Sc3* relative to *Sc1*, and we see that the cost for *Sc2* is around 8% higher in 2050 compared to *Sc1*.

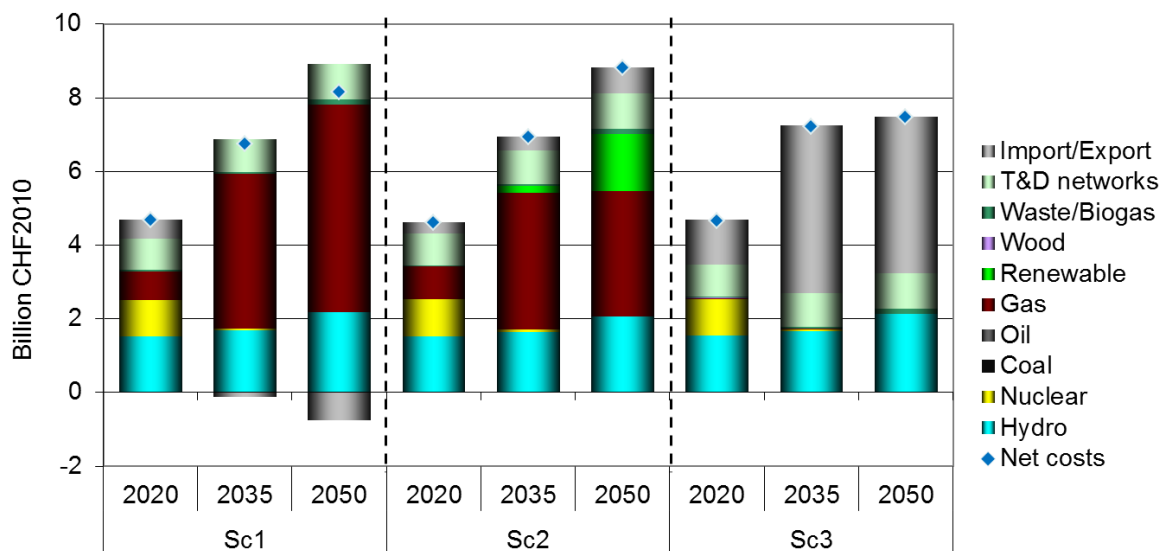

Figure 27: Undiscounted system costs (Switzerland): Technology breakup

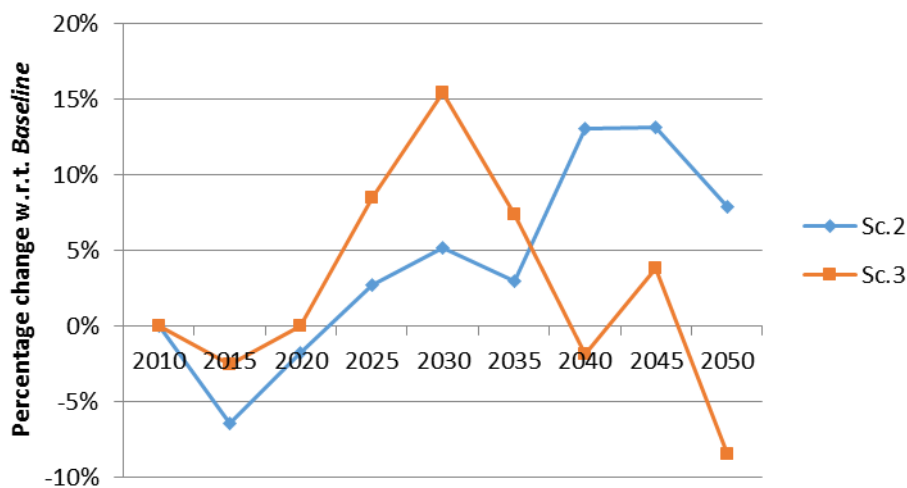

Figure 28: Average cost of electricity (Switzerland)

The Sc3 scenario has the lowest system cost amongst the three scenarios. The cost of imported electricity (i.e. trade balance) makes up the major share of the total system costs – 27% of the total costs in 2020, 63% in 2035 and 57% in 2050, because imported electricity constitutes a major part of electricity supply in Switzerland as a result of the relaxation of the self-sufficiency constraint. In 2020, costs of import are still cheap giving the Sc3 the lowest net system costs and thus average electricity cost among the three scenarios (see Figure 28). As the CO₂ constraints become more stringent by 2035, cost of imported electricity becomes high due to capital intensive investments in renewable and CCS technologies in the neighbouring countries. By 2050, cost of electricity imports reduces further owing to lowering costs of renewables and CCS plants due to technology learning, thereby making Sc3 the cheapest in terms of average costs by 2050 (by around 8% by 2050 compared to Sc1, Figure 28). It is worth noting that the system is optimized for the all five regions together, and the relaxed self-sufficiency constraint makes it feasible for Switzerland to import cheap low carbon electricity.

2.1.11.2.5 CO₂ emissions

Figure 29 shows the CO₂ emissions from the five countries for all three scenarios. In the *Sc1* scenario, the total emission increases in the short term (till 2020) due to increased coal based electricity supply in Germany to replace the existing nuclear capacity. In the later years, the CO₂ tax becomes sufficiently high to make investment in renewables and CCS technologies competitive and hence reduce the emissions. The figure also shows the extent to which each country reduces their CO₂ emissions to meet the emission targets in the low carbon scenarios. In *Sc2*, Switzerland still contributes to the total CO₂ emissions, while there are no emissions from Switzerland in *Sc3* due to the restriction on investments in gas plants. This results in slightly higher emissions in Germany, which invests slightly more in normal gas plants than in the more expensive gas CCS plants.

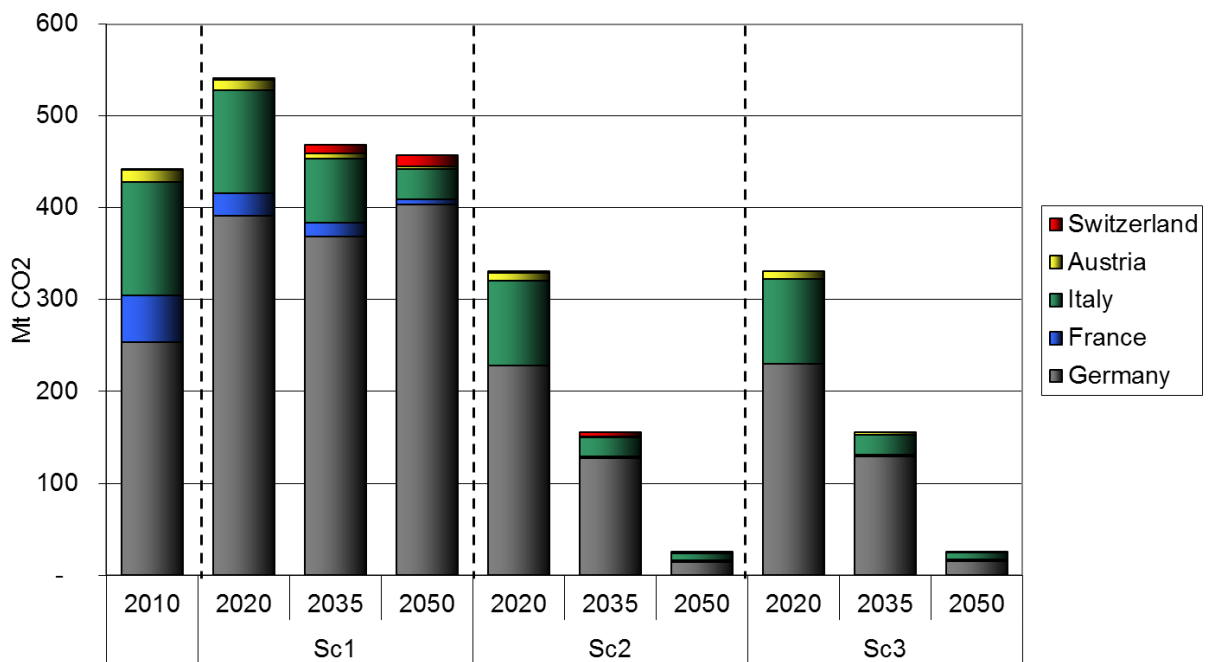

Figure 29: CO₂ emissions: regional disaggregation

2.1.12 Advantages of CROSSTEM over CROSSTEM-CH

This section highlights some of the strengths of a multi-region model like CROSSTEM with endogenous electricity trade, over a single region Swiss electricity model like STEM-E or CROSSTEM-CH with exogenous electricity trade price assumptions. To illustrate the differences, the *Sc1* scenario of CROSSTEM is compared with the '*Sc.1* equivalent' *Baseline* scenario from the coupled framework (presented in section 1.4.1), as they have identical electricity demand and supply options for Switzerland. The results are compared with respect to the electricity generation mix and generation schedules to understand the underlying drivers.

2.1.12.1 Electricity generation mix

Figure 30 shows the electricity generation mix for Switzerland from both models. Although the technology mix is similar in the near term (2020), there are significant differences in the long run. In 2035 for instance, both models have around 100 PJ from gas-based electricity generation. However, in the *Baseline* scenario from the CROSSTEM-CH model, around 80% of the gas-based electricity generation

originates from **base-load type plants**, whereas in the CROSSTEM model only around 45% is generated by base-load plants, with the majority share from **flexible plants**. An even larger difference is observed in the year 2050 in terms of generation mix and type of gas plants. While CROSSTEM-CH chooses a considerable quantity of **solar PV** in the generation mix, no solar PV investments are made in CROSSTEM. Moreover, as seen in 2035, most of the gas plants in CROSSTEM-CH are base-load type (80%), whereas the major part comes from flexible gas plants (54%) in CROSSTEM. There are two main reasons for this difference in technology choice, viz. “load dumping” in the single region model which is not possible in CROSSTEM, and uncertainties in the exogenous import/export prices assumption in CROSSTEM-CH.

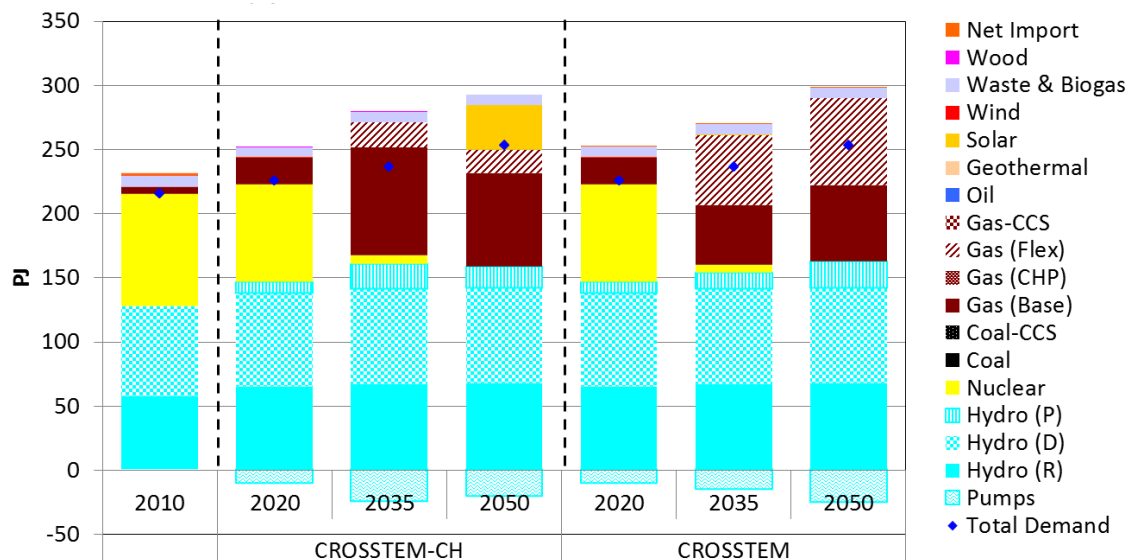

Figure 30: Electricity generation mix (Switzerland): CROSSTEM-CH (Baseline) vs CROSSTEM (Sc1)

“Load dumping” is a term used to describe the phenomenon of dumping excess electricity to neighbouring countries without any knowledge of their markets. In a single region model like CROSSTEM-CH, the electricity imports/exports are exogenously defined. Although there are bounds on total trade volume as well as market share constraints to replicate historical trading patterns with neighbouring countries, there is no restriction on the timing of the imports or exports. This means that imported electricity is assumed to be available whenever there is a demand, and electricity can be exported whenever there is an excess generation. In reality, neither of these two conditions are true, but it is a common compromise made in single region models. This issue is partly addressed in the CROSSTEM model, wherein electricity can be imported only when there is excess generation in the surrounding countries. Similarly, the exports are only possible when there is a market (i.e. demand) in the surrounding countries. This is why in the *Baseline* scenario of CROSSTEM-CH, most of the gas-based generation is produced from base-load plants, which are more efficient (and hence cheaper) than flexible gas plants. In contrast, Switzerland in CROSSTEM has to invest more in flexible gas plants to be able to optimize the trading patterns with the real market of the neighbouring counties (and *vice versa*).

The second driver is the assumption on electricity trade price. Figure 31 shows the exogenously given electricity import/export price assumptions²⁰ in the CROSSTEM-CH model versus the marginal cost of electricity in the surrounding countries of Switzerland obtained from CROSSTEM. As can be seen from the figure, the exogenous import/export price assumptions in CROSSTEM-CH are relatively higher in all time slices than in CROSSTEM except for winter weekdays²¹. This implies that exporting electricity in summer or spring is as attractive for CROSSTEM-CH as in the winter season, since it fully ignores the source of import and/or market for export. Whereas in the CROSSTEM, electricity prices in winter are much higher than in the other seasons reflecting high demand across all regions in winter. The differences in trade prices partly explain the reason for the cheap base-load type gas plants and investments in solar PV in CROSSTEM-CH. The high electricity price assumption during the peak hours in summer is based on the historical market trend. Thus, the solar PV becomes an attractive option in CROSSTEM-CH to generate excess electricity since it is assumed that there is a market to export the electricity from solar PV. However, the full framework (CROSSTEM) indicates that there is no market to import the summer electricity generated from solar PV in Switzerland. This was validated by running the CROSSTEM-CH model using the marginal costs from the *Sc1* scenario of CROSSTEM. In this case, the generation mix from CROSSTEM-CH resembles that of the *Sc1* scenario – i.e. no solar PV based electricity generation due to lower summer electricity prices. However, trade volumes and trade patterns in the CROSSTEM-CH model were still very different compared to CROSSTEM, reasons for which are explained in the following subsection.

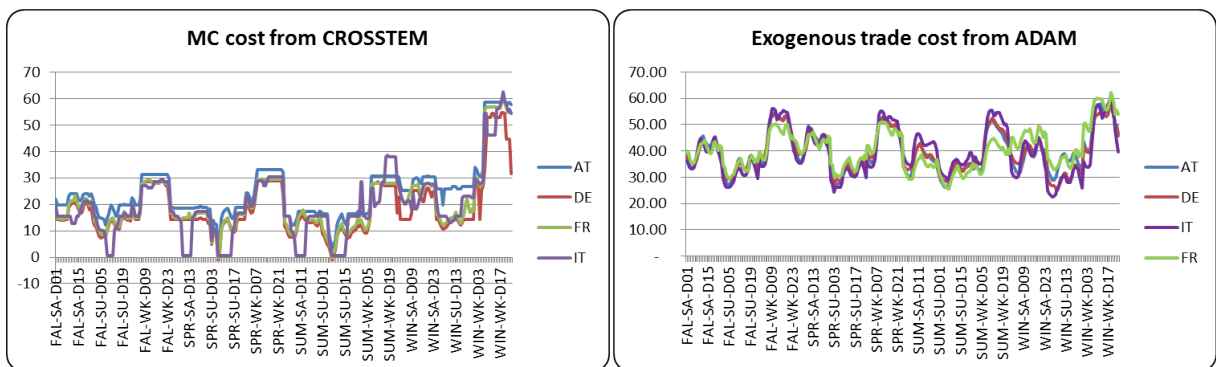

Figure 31: Electricity import/export costs for Switzerland - CROSSTEM (endogenous) vs CROSSTEM-CH (exogenous)

2.1.12.2 Electricity generation schedule

Figure 32 shows the differences in the electricity generation schedules in Switzerland between the two models on a summer (Figure 32a) and winter (Figure 32b) weekday in 2050. As mentioned before, the import/export trade profiles in CROSSTEM-CH are purely driven by the exogenous trade price assumptions, whereas in CROSSTEM, the trade is endogenous, and import/export patterns are highly dependant on supply options and demand in neighbouring countries (Figure 25).

²⁰ An hourly price assumption is estimated based on annual cost of electricity supply from the ADAM model. The methodology is explained in Kannan/Turton 2011.

²¹ It should be noted that the import prices adopted from the ADAM model were for a stringent climate scenario, resulting in high import prices (Fraunhofer 2010).

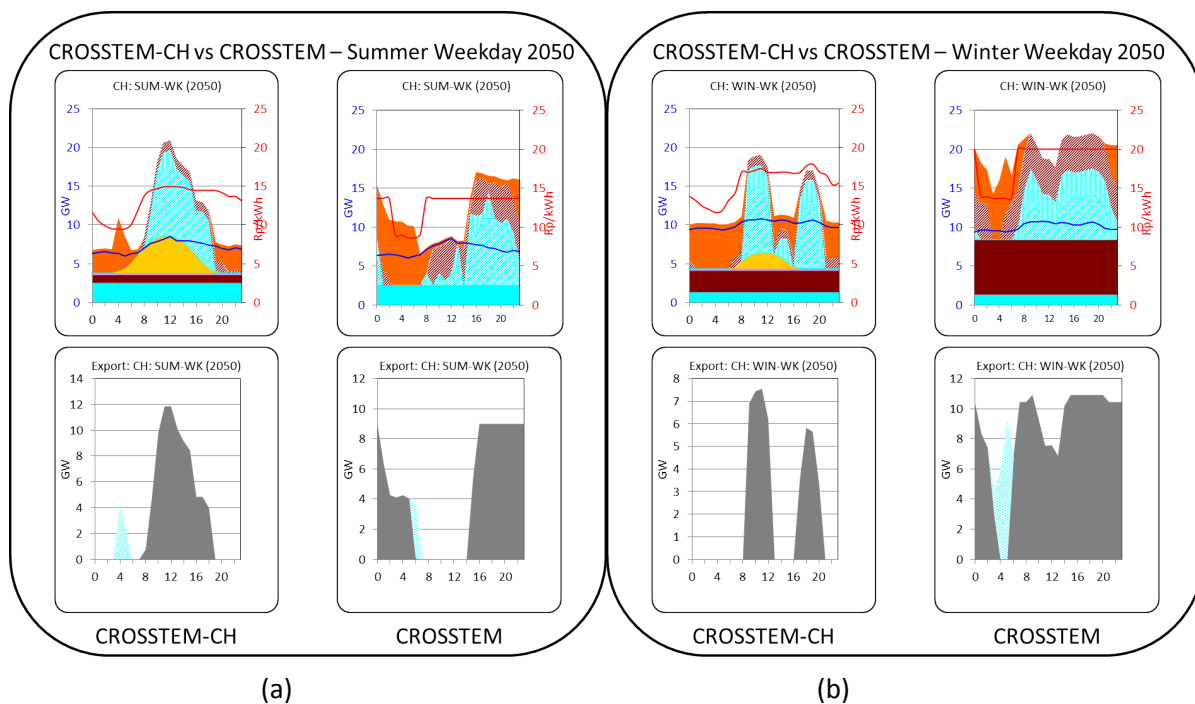

Figure 32: Electricity generation schedules - CROSSTEM-CH vs CROSSTEM

In the summer, CROSSTEM-CH dispatches all the flexible hydro from 08:00-16:00, supplementing to the solar PV generation to export maximum electricity during these peak hours, with imports required to meet the demand in early morning and late evenings. In CROSSTEM on the other hand, most of the imports occur during the early morning hours which is simultaneously also exported (see Figure B 13 in Appendix B for more details), with no export during the daytime hours 08:00-16:00. Dam/pumped hydro and flexible gas plants are scheduled during the evening hours to be exported from 16:00-00:00.

In winter (b), electricity is imported almost throughout the day in CROSSTEM-CH, except for the two peak hours between 09:00-12:00 and 17:00-19:00, where electricity price is assumed to be high. All the flexible generation is scheduled for these hours, thereby maximizing export trade revenue. In CROSSTEM, marginal costs of electricity in winter are very high, which makes it very attractive for Switzerland to export electricity. Hence, full capacity of the installed gas plants is scheduled in winter, supplemented by dam and pumped hydro. As mentioned before, this import/export pattern for Switzerland in CROSSTEM is only possible because of matching conditions in the surrounding countries (see Figure B 14 in Appendix B). Hence, the profiles from CROSSTEM are more consistent than those obtained from CROSSTEM-CH, which would have similar import/export patterns for all scenarios (see Figure 58 in section 3.1.3.4).

The limited set of scenarios presented in Section 2.1.11.1 (Figure 20) with the assumed set of boundary conditions shed powerful insights on the development of the Swiss electricity system, which would not have been possible with a single region model. Thus, the CROSSTEM is very a powerful tool to explore different boundary conditions of the neighbouring countries to generate insights for policy decisions.

2.1.13 Model limitations and uncertainties

Although we tried to implement consistent datasets (e.g. future electricity demand assumptions, technology cost curves, resource cost and potentials etc.) wherever possible, they are potential sources of uncertainties and affect model results. Some limitations and uncertainties are described below.

- The future electricity demands are highly uncertain, and depend on their underlying drivers such as population growth, economic development, electrification of end use sectors, etc. It is a potential parameter for sensitivity analysis.
- Future technology cost assumptions depend on technology breakthroughs, which are highly uncertain.
- Resource potential of new renewables varies across literature, and is constantly updated. The renewable resource potentials in CROSSTEM are currently linearly interpolated between the 2010 level and 2050 potentials (Table 6, page 43), which limits an early/accelerated uptake of renewables.
- Some of the scenario specific user constraints are arbitrary assumptions. For example, future trading patterns, especially with fringe regions are highly uncertain. Countries that are currently net exporters could become net importers depending on national policies as well as developments in surrounding countries. Also, trade with the fringe regions is modeled as a flexible technology, but the source of supply or market for export is highly uncertain.
- Although CROSSTEM has an hourly representation, it is not a dispatch model. Technology availability factors specified in the model represent a yearly technical availability factor, which includes outages due to scheduled maintenance, refuelling etc. However, unplanned outages are not captured in the model. Neither are issues such as start-up time nor ramp up rates incorporated. The reserve margin is assumed to cope with such issues.
- The representation of the average day is an oversimplification in CROSSTEM, although such simplifications are common in many analytical frameworks due to computational constraints. For example, wind and solar PV availability factors are averaged over a season and week, and hence short term intermittency are not fully captured. However, the simplified intra-annual resolution largely complements the long model horizon of CROSSTEM.
- Transmission and Distribution (T&D) networks are not modelled in any detail, i.e. the countries are modelled as single copper plate regions. There are some costs assigned to the transmission system (network tariff), but no explicit transmission lines are considered. Even though costs of interconnectors between countries are represented, losses are not included and are assumed to be captured by general assumptions on T&D losses (see section 2.1.7.6).
- Finally, the model assumes perfect information, perfect foresight, well-functioning markets and economically rational decisions, which is not always true in the real world. Moreover, the cost is optimised (minimised) for all the five countries together, and it may not represent the optimal solution for each country individually.

2.2 GENESwIS

2.2.1 Introduction

GENESwIS is a dynamic computable general equilibrium (CGE) model of the Swiss economy designed to analyze energy and environmental policies (Vöhringer 2012).

In GENESwIS, agents act rationally and have perfect foresight over the entire time-horizon (2010-2050). Households maximize their utility under a budget constraint. They earn wages by providing labor and receive a rate of return by renting out capital. As a further element of income, they receive social benefits from the Government. Firms maximize profit under technology constraints and the assumption of perfect competition. Non-satiation in consumption implies that demand equals supply in all markets. The Government collects taxes (income tax, value added tax, mineral oil tax, CO₂ tax) and uses the revenue for lump-sum transfers (social benefits) and public goods provision. Equal yield is assumed, hence the income tax rate is modified to keep public goods provision constant. Domestic and foreign goods are assumed to be imperfect substitutes and are aggregated following Armington's description of a small open economy. Capital is modeled as putty-clay to incorporate the rigid character of investment decisions and crowding out of investments. Thus, free capital invested into one sector (Industry, Services or Electricity) cannot be transformed back into capital for another sector. Investments are treated as solely domestic. GENESwIS exhibits flexible labor supply such that agents can choose between labor and leisure. Relative prices are adjusted until every agent reach their optimal demand or supply.

GENESwIS is based on the 2005 Energy related disaggregation of the Swiss Input-Output Table, Nathani et al. 2011.

GENESwIS has been modified with the purpose of being coupled with the Cross-Border TIMES Electricity Model (CROSSTEM).

2.2.2 Model structure

2.2.2.1 Production

The GENESwIS model is designed to analyze energy and environmental policies. This is represented in the modeling structure, which gives special attention to the use and production of energy. The nesting structure for the production functions, with the exemption of Electricity, Electricity Transport and Distribution, and Rail Transport, is displayed on Figure 33. The top structure, linking capital, labor, energy and other inputs is a standard and recognized structure (see for example Paltsev et al. 2009 and Böhringer et al. 2010). The energy nest, more disaggregated, was designed with the idea that not much substitution would happen between the three different types of energy use: transport, appliances and heat. Whereas, within these types of energy uses, different fuels, or types of production can be substituted to each other.

Transport is separated between own transport and transport services. Own transport is constituted of transport fuels and electro-mobility (see section 2.2.3.1). Transport services are disaggregated by mode: Road, Rail, and Air and Other transports (incl. water and pipelines). It is assumed that different modes of land transport have a greater chance to be substituted for each other than for non-land transports (air, water or pipeline).

The heating nest is composed of inputs of natural gas, light heating oil, district heating, and retail electricity (ETD). The input from Construction (CON) is included to model insulation. Thus, energy use can be substituted, to a certain extent, by better insulation.

The input of retail electricity (ETD) into the top energy nest mostly represents the use of electric appliances.

Sectoral disaggregation

GENESwIS' sectoral disaggregation is designed for the analysis of energy and environmental policies with an emphasis on the electricity sector. Non-energy industries are separated into aggregates taking into account their possible importance in the formation of capital for the electricity sector and their affiliation to different CO₂ taxation schemes (ETS, CO₂ tax). The sectoral disaggregation is displayed in Table 9 and the commodities demanded in the model in Table 10.

The goods produced by the refinery sector are disaggregated between transport fuels (TFU), i.e. Diesel and petrol, and light heating oil (HFU); non-fuel products are allocated to the Rest of Industry commodity. Hence, the uses and emissions of different fuels can be tracked and taxed separately. To reflect some flexibility existing in the refinery production, the output of the refinery sector is transformed into TFU, HFU and ROI through a constant elasticity of transformation (CET) function (see Figure 34) with an elasticity of transformation of 0.2.

Table 9: GENESwIS' sectors

Energy	Transport	Non-Energy
Electricity:	Rail (RLT)	Agriculture (AGR)
- generation (ELE)	Road (RDT)	Cement and concrete (CMT)
- transport and distribution (ETD)	Air & others (ATP)	Construction (CON)
Natural gas		Metals (MET)
- transport and distribution (GAS)		Other ETS sectors (ETS)
District heating (DHT)		Rest of industry (ROI)
Refineries (RFU)		Rest of services (ROS)

Table 10: GENESwIS' commodities

Energy	Transport	Non-Energy
Electricity:	Rail (RLT)	Agricultural goods (AGR)
- wholesale (ELE)	Road (RDT)	Cement and concrete (CMT)
- retail (ETD)	Air & others (ATP)	Construction (CON)
Natural gas (GAS)		Metals (MET)
District heat (DHT)		Other ETS commodities (ETS)
Petrol and Diesel (TFU)		Rest of goods (ROI)
Light heating oil (HFU)		Rest of services (ROS)
Crude oil (only imported) (CRU)		
Nuclear fuel (only imported) (NUC)		

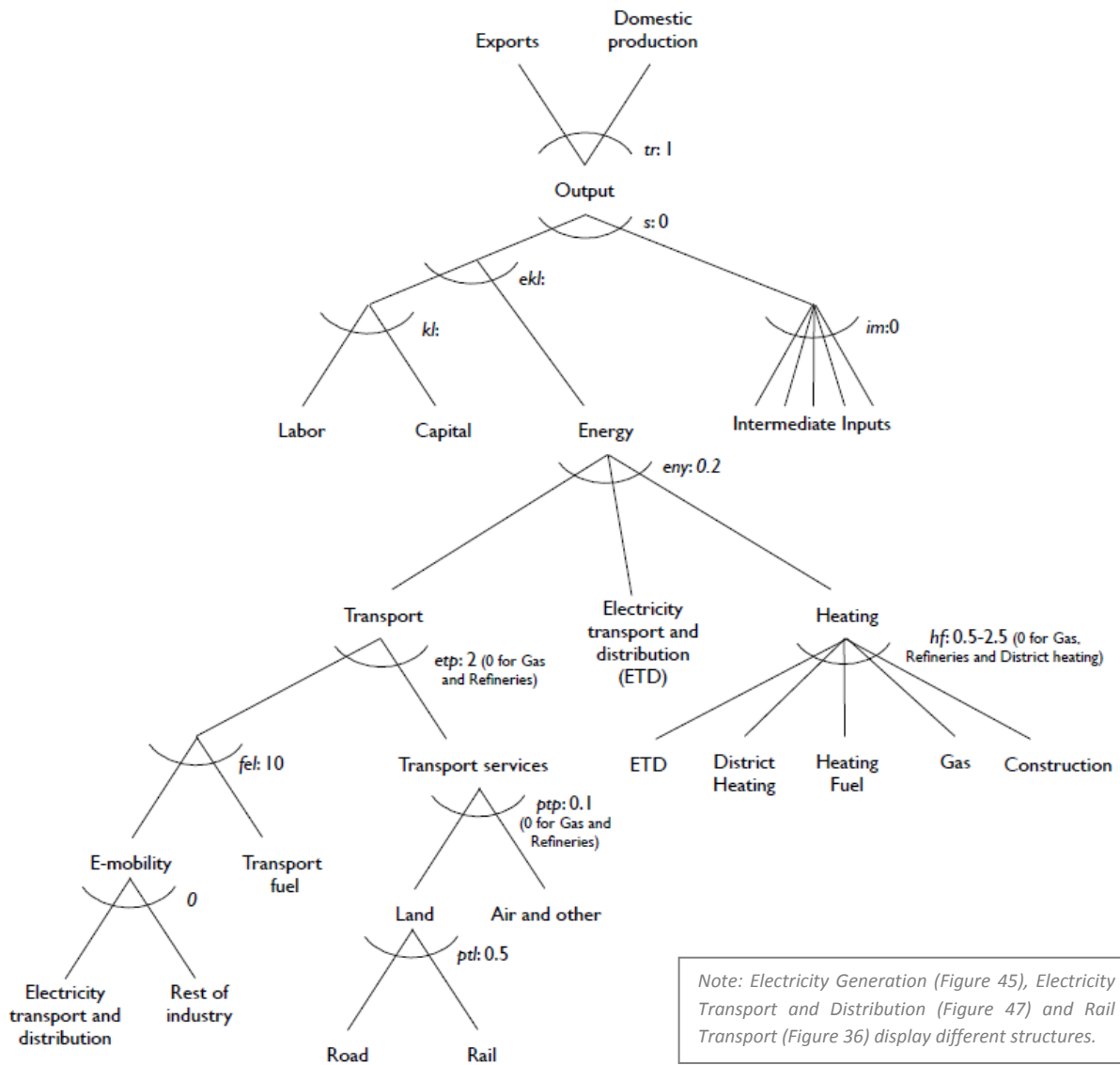

Figure 33: Nesting structure for GENESWIS' production functions.

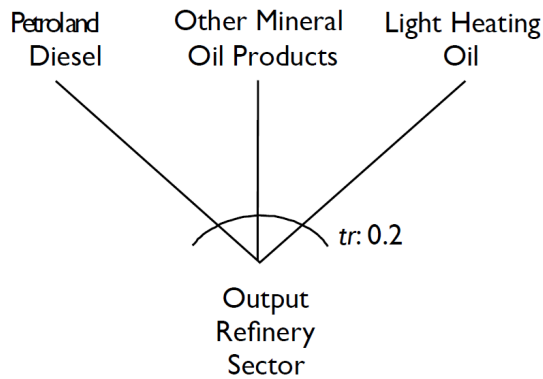

Figure 34: Constant elasticity of transformation (CET) function's structure for the Refinery sector (RFU).

2.2.2.2 Consumption

Households can choose between consuming goods and services, and enjoying leisure time. They optimize their consumption choice between different periods, which determines saving behavior.

Households can substitute between the different goods and services with an elasticity of substitution of one. Energy consumption is specified precisely (as it is for sectoral production) to permit energy and environmental analysis. However, transport is modeled differently than for production, as households have a more flexible choice between land and air transport.

The nesting structure for consumption is given in Figure 35.

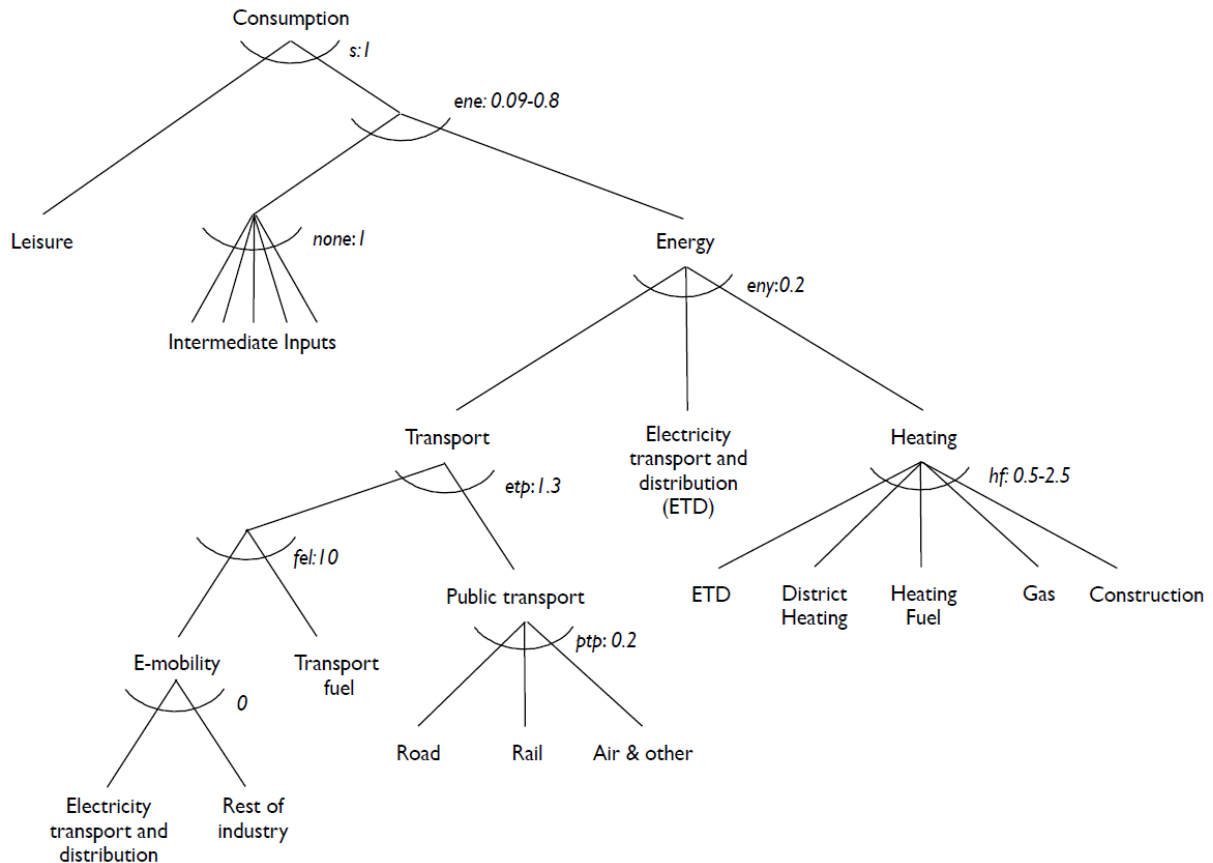

Figure 35: Nesting structure of the GENESwIS model for household consumption.

2.2.2.3 Government and taxes

The Government collects taxes and uses the revenue for lump sum transfers (social benefits) to the households, and for public goods provision.

Social benefits (transfer to households) are set, in the model, to be equal to the remaining of the household budget balance. The "Compte global des assurances sociales (CGAS) par branches d'assurances sociales" (table T13.3.1.1, OFS) gives a social benefit of 57'471 mio CHF in 2005, which coincides with the value obtained balancing the household budget with the Swiss input-output table data.

An equal yield condition is introduced into the model such that public goods provision stays constant. As we assume that the public budget needs to balance in all simulations, the income tax adjusts to keep Government revenue constant.

The model includes two types of taxes and subsidies: (1) benchmark and (2) baseline (section 2.2.4.3) and scenario taxes and subsidies (section 1.4.1).

Benchmark taxes

Benchmark taxes exist already in the initial equilibrium. Taking them into account allows for the consideration of possible efficiency gains of scenario policies. Efficiency gains can appear if policies recycle revenues in a way that reduces the excess burden of the tax system.

In the energy related disaggregation of the Swiss Input-Output Table, labor and capital taxes are not specified, but form the Value Added (VAD) aggregate along with capital and labor while the other taxes are aggregated into "Net Commodity Taxes". The Value Added Tax (VAT) is specified for intermediate and final consumption in a separate table of the Swiss IOT.

The IO table tax payments are disaggregated to model the following benchmark taxes in GENESWIS:

- Income and capital taxes. Source: OECD.
 - Income tax (on a gross basis, adding 1.2% for family allowance): 22.1%.
 - Capital tax (on a gross basis, taxation of corporate and capital income): 21.3%.
 - The income tax is constrained to induce equal yield.
- Value Added Tax (VAT): non deductible VAT, and VAT on household consumption. Source: Nathani et al. 2011.
- Mineral Oil Tax. The mineral oil tax payments by sectors are given by Nathani et al. 2011. Mineral oil tax rates are calculated by fuels (transport fuels, heating fuels and gas) and by group of users and levied as quantity based taxes.
- Remaining taxes (= NCT – VAT – mineral oil tax).
 - Remaining taxes on domestic production.
 - Remaining taxes on household consumption.
 - Remaining taxes on government consumption.
 - Remaining taxes on investments.

2.2.2.4 Trade

The Armington representation of trade treats domestic and foreign goods and services as imperfect substitutes. Armington elasticities are taken from GTAP and GTAP-E data (Hertel 1997 and Burniaux/Truong 2002, see Table 13, page 72).

No natural gas is extracted in Switzerland: all natural gas is imported. However, the IOT displays some domestic production in the gas sector (GAS) that accounts for transport and distribution services. In order to keep the right technology (mere fuel in proportion to transport and distribution costs), the Armington elasticity of GAS is set to zero.

Crude oil (CRU) and nuclear fuels (NUC) are solely imported goods, when District heating (DHT) is only domestic.

The IOT reports imports for Electricity transport and distribution (ETD), and not for Electricity generation (ELE). However, imports of ETD are actually priced only to the border (C.I.F. prices). This situation is identical to electricity being produced at the border (i.e. generated at a plant located on the border). In order to obtain a better representation of the pricing of the transport and distribution of these imports (from border to users), the electricity imports are attributed to ELE. All ELE production enters ETD as intermediate input, hence, transport and distribution costs are added to the C.I.F. price of electricity imports.

When coupling GENESwIS to the CROSSTEM model, electricity trade is governed by the CROSSTEM model.

2.2.3 Electricity supply and demand

Given that CROSSTEM allows for a precise optimization of electricity supply, based on extensive technology data, the structure and price of electricity supply acquired through the CROSSTEM model is used to specify GENESwIS' electricity generation production function. However, as the CROSSTEM model does not specify transport and distribution costs with as much detail as it does electricity generation, the electricity sector in GENESwIS is separated into Electricity generation (ELE) and Electricity transport and distribution (ETD). Electricity generated (ELE) is demanded solely by the ETD sector. Electricity transported and distributed (ETD), i.e. retail electricity, is then demanded for intermediate and final consumption.

To model electricity demand the most accurately possible within the GENESwIS model, electricity (ETD) was disaggregated into three different uses with the help of Prognos 2012 data:

- electricity used for heating,
- electricity used for transport,
- electricity used for appliances.

This disaggregation permits to model substitution opportunities between ETD and other energy carriers more realistically: Electricity used for heating enters the heating nest and can be substituted against other heating commodities. Electricity used for transport is modeled as electro-mobility in the transport nest (see section 2.2.3.1), and electricity used for appliances enters the top energy nest (see Figure 33 and Figure 35).

2.2.3.1 Electro-mobility

Electro-mobility is modeled as a sub-nest in transport (see Figure 33 or Figure 35), where it can be substituted with transport fuels through an elasticity of substitution of 10. This very high elasticity of substitution was chosen for calibration purposes due to the very small current share of electro-mobility and the high penetration projections.

Electro-mobility is composed of Retail Electricity (ETD) and Rest Of Industry (ROI) in fixed shares. In the calibration stage, substitution with Transport Fuels (TFU) is induced by changing the quantity of ROI in the production function of electro-mobility with the help of an efficiency index, which reduces the cost of electro-mobility over time.

This permits to calibrate the electro-mobility demand to the projections of Prognos 2012. This crude representation is a first less-than-perfect attempt to reflect the increasing importance of e-mobility, matching existing projections.

In the Rail transport sector, e-mobility is not modeled as such, as a large share of the fleet is already electrified (see Figure 36).

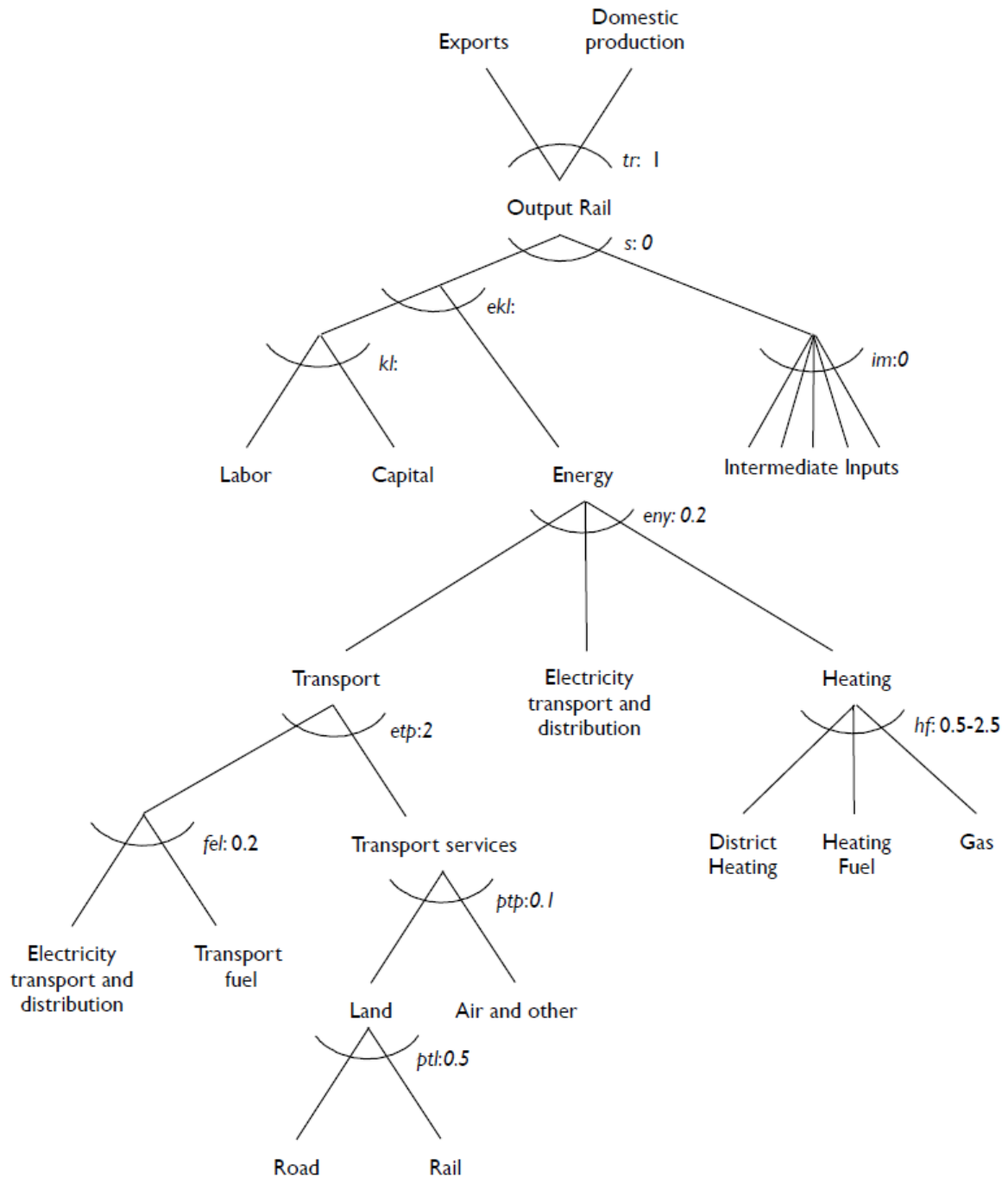

Figure 36: Nesting structure of the production function for Rail Transport (RLT).

2.2.4 Baseline and dynamic calibration

2.2.4.1 Steady state calibration

GENESwIS is a Ramsey-Cass-Koopmans model based on a steady state growth path. In the steady state, all quantities in the model such as capital, output, consumption etc. grow at the same constant rate

$$Q(t) = (1 + g)^t \cdot Q(t_0) \quad (2.2.1)$$

with Q the quantity, g the growth rate, t the time-period, and t_0 the initial time-period.

At a given period, the present value of utility is given by $((\frac{1}{1+r})^t \cdot Utility)$, where the factor $(\frac{1}{1+r})^t$ relates to the time preference of the consumer, reflected in the rate of time preference r , which at the same time serves as the interest rate.

For the model to be correctly calibrated on the steady state path, initial investments I_0 are defined proportionally to the initial capital stock VK_0 in the following way (see for example Paltsev 2004):

$$I_0 = \frac{(\delta + g)VK_0}{\delta + r} \quad (2.2.2)$$

with growth rate g , interest rate r and discount rate δ .

Investments and capital stock are given by the input-output table. However, they might not satisfy equation (2.2.2) for the assumed growth, interest and discount rates.

We analyzed the different combinations of interest rates r and depreciation rates δ such that (2.2.2) holds. We opted for the following reasonable combination with a growth rate of $g=1\%$, an interest rate of $r=4.5\%$ and a depreciation rate of $\delta=4.5\%$, and implemented it in both GENESwIS and CROSSTEM.

The time horizon for the study is set from 2010 to 2050. However, to avoid boundary effects, namely due to terminal capital conditions, the model is run until 2070. Special care must be taken regarding terminal capital conditions. If no constraint is introduced in the model, agents will not save in the last periods. We introduced the following constraint to force investments to grow at the same rate as production in the last period (see for example Paltsev 2004):

$$\frac{I_T}{I_{T-1}} = \frac{Y_T}{Y_{T-1}} \quad (2.2.3)$$

with I total investments, Y total production and T the final period.

To keep the model at a reasonable and solvable dimensionality, and to be in line with the time-steps of the CROSSTEM model with which GENESwIS is being coupled, 5-years time-steps are modeled. This requires adjustments of the investment activity and terminal investment activity.

2.2.4.2 Baseline calibration and policies

The chosen baseline (or reference) scenario for this study is based on the *weiter wie bisher* scenario of the Swiss Energy Perspectives (Prognos 2012). As this scenario realistically deviates from a steady

state growth path, we calibrate the model such that the following quantities follow the paths projected by Prognos 2012:

- labor,
- Gross Domestic Product (GDP),
- electricity demand (per sector and use),
- CO₂ emissions per fuel.

Labor growth is composed of two factors: (1) active population growth and (2) productivity growth. The full-time equivalent forecast is taken from the scenario (A-00-2010) of the FSO. The SECO, in their GDP projection, assume a productivity growth of 0.9% per year. We combine the two to get total labor growth, see Figure 37a. Labor growth is introduced exogenously in the model, and GDP growth follows SECO's projection assumed in the *weiter wie bisher* scenario (Prognos 2012) (see Figure 37b).

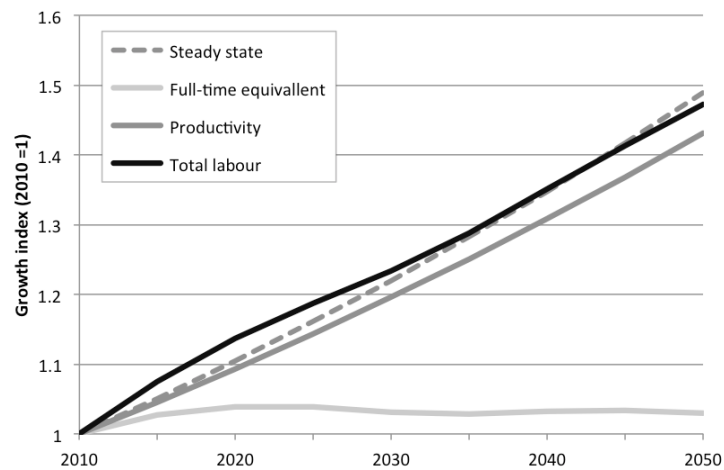

(a) Labor growth

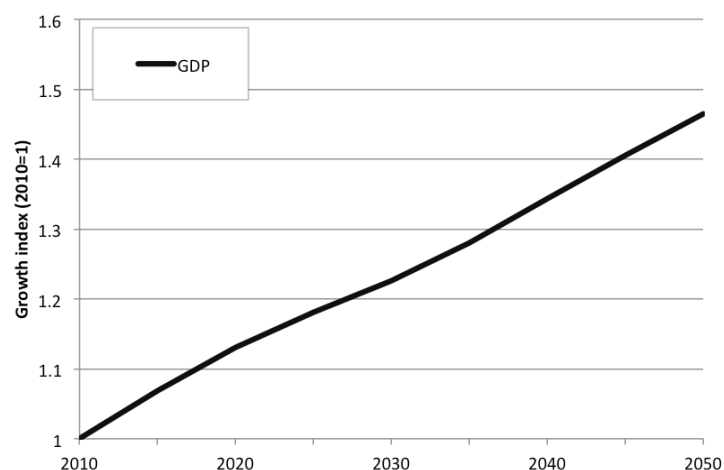

(b) GDP growth

Figure 37: Macroeconomic assumptions: (a) Labor growth and (b) GDP growth.

Electricity demand per sector (industry, services, transport and households, see Figure 38a) and per use (transport, heating and others, see Figure 38b), as well as CO₂ emissions per fuel (gas, transport fuels and heating fuel demands) are calibrated to follow the forecast by Prognos 2012 for the *weiter wie bisher* scenario. They are calibrated with the help of autonomous energy efficiency indices.

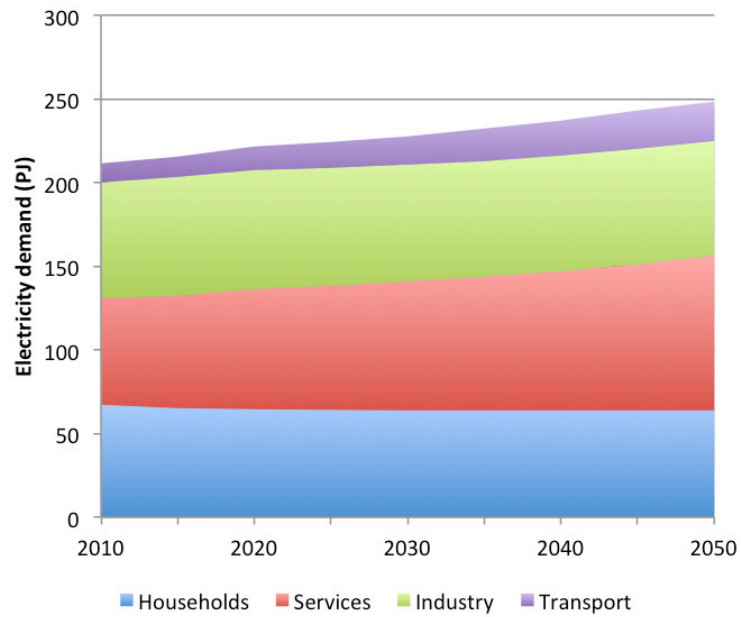

(a) Electricity demand per sector

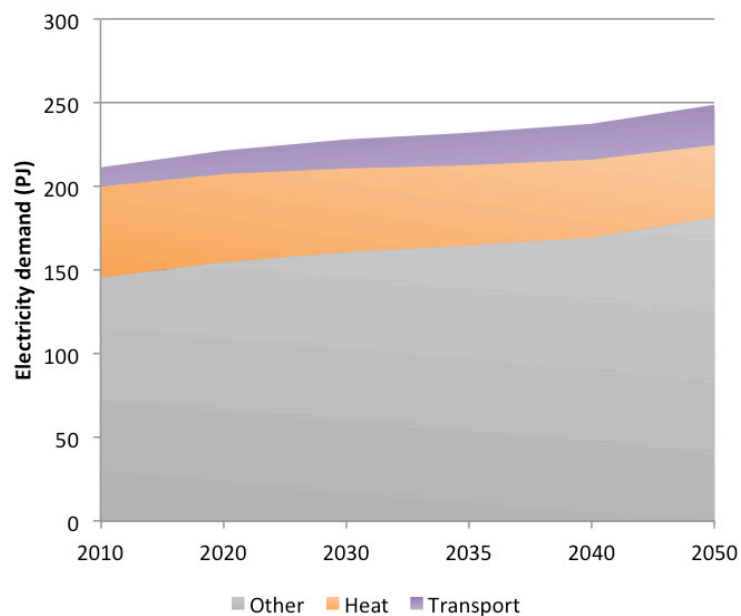

(b) Electricity demand per use

Figure 38: Electricity demand in Switzerland per sector and per use. Source: Prognos 2012.

These indices represent reductions in demand that are due to technology improvement, i.e. not directly linked to price signals.

Table 11: World energy prices [CHF₂₀₁₀ /GJ] (Source: IEA 2010 and own calculations), and CO₂ permit prices [CHF₂₀₁₀ /ton] for sectors that belong to the ETS scheme (Source: Prognos 2012 and own calculations).

	2010	2015	2020	2025	2030	2035	2040	2045	2050
Crude oil	12.26	15.60	17.08	18.12	18.98	19.50	19.90	20.30	20.65
Gas	8.54	10.61	11.61	12.31	12.91	13.31	13.48	13.74	13.96
CO₂	15.58	27.53	39.48	43.63	47.79	51.95	55.06	56.62	58.18

Import prices for imported energy carriers are set according to projections of the World Energy Outlook 2010 (which were used by Prognos 2012). A logarithmic fit was used to extrapolate the missing years. CO₂ permit prices for sectors entering the ETS scheme are given by Prognos 2012. These prices were harmonized with the inputs of the CROSSTEM-CH model. Prices in CHF of 2010 can be found in Table 11.

The following baseline policies are implemented:

- Emissions Trading Scheme (ETS): sectors that belong to the ETS must buy permits for CO₂ emissions due to heating fuels and for geogenic emissions. Aviation is included in the ETS scheme in 2020 in the model (start in 2020 due to 5-year time-steps) and trades ETS permits for CO₂ emissions from transport fuels. CO₂ permit prices follow the projections by Prognos 2012 (see Table 11).
- A CO₂ tax on light heating oil and natural gas is levied on non-ETS sectors and household consumption. The CO₂ tax is set on the following levels: 36 CHF₂₀₁₀ /t in 2010, 60 CHF₂₀₁₀ /t in 2015 and 72 CHF₂₀₁₀ /t in 2020 and following years.
- Subsidy for the refurbishment program: 280 mio CHF from the CO₂ tax revenue is used to incentivize insulation (input of Construction in the heating nest). The remainder of the CO₂ tax revenue is recycled as a lump-sum transfer to households.

2.2.5 Data

2.2.5.1 Input-output table disaggregation

GENESwIS is based on the 2005 Energy related disaggregation of the Swiss Input-Output Table, Nathani et al. 2011. The IO table was further disaggregated to better suit the needs of an analysis on the electricity sector and energy/environmental policies. The following changes were made:

- "Non metallic mineral products" are divided into "Cement and concrete" (CMT) and "Rest of non metallic mineral products". Data source: reports from Cemsuisse 2011 and 2005. It is assumed that the whole production of Cement and concrete is consumed by the Construction sector.
- The commodity "Coke and refined mineral products" is separated into "Heating fuels" (HFU), "Transport fuels" (TFU) and "Other refined mineral products" (the latter is allocated to Rest of industry). The Refinery sector (RFU) is kept aggregated, because of the integrated

nature of its processes. The sources used for this disaggregation are: Energy NAMEA data and Swiss report on energy statistics (BFE 2006).

- "Crude oil" (CRU) is separated from "Products of mining and quarrying" and is solely composed of imports.

The value added in the IOT is not disaggregated between capital and labor. It is important for the model to separate labor, capital and income taxes. Hence, labor was calculated from: "full time equivalent 2005" data (T2.8a BFS) and "gross monthly wage according to economic sector, 2006" (BFS). Income taxes were taken from OECD data. Capital was then set as the remainder of value added.

To model insulation, an input of Construction is included in the heating nest. The total sum of this input is set to 5% of total Construction demand (excl. own demand and road and infrastructure, which amounts for 1/3 of total construction (see Körber and Kaufmann 2007). The input of insulation into each sector is distributed according to the respective sector's share in total demand for heat. This way, each sector has the same benchmark value share of insulation in its heating nest. Insulation is not modeled for the energy sectors (ELE, ETD, GAS, DHT and RFU) because their inputs of heating fuels are used mostly for industrial processes rather than for heating buildings. Nor is insulation modeled for the Construction and Transport sectors.

2.2.5.2 Elasticities of substitution

The elasticities of substitution used in GENESWIS are listed in Table 12.

The elasticities of substitution between capital and labour (KL nest, see also Figure 33 and Figure 35), are derived from Mohler/Müller 2012. Mohler/Müller 2012 compute elasticities for a similar structure as GENESWIS' for the Swiss manufacturing industry on a timeframe of 14 years and give elasticities for the following sectors: ROI, ETS and MET. To account for long-time elasticities as much as short-time elasticities in GENESWIS, the elasticities of substitution are set to be linearly dependent of time. As the elasticities in Mohler/Müller 2012 are calculated on a 14 year database, these values are used for 2025 and are doubled for 2050. A linear approximation is fitted through these two points. It is assumed that the remaining sectors will display the same elasticity as the ROI sector.

The elasticities between energy and the capital and labour nest (KL,E nest, see Figure 33 and Figure 35), are taken from Mohler/Müller 2012 for ROI, ETS and MET, and from Ban/Okagawa 2008 for the rest of the sectors. A similar linear fit as for the KL nest elasticities is set up. As Ban/Okagawa 2008 compute their elasticities on a timeframe of 19 years, the base-points of the elasticities are set in 2030, doubling in 25 years.

Elasticities of substitution for the heating nest are chosen to increase linearly from 0.5 in 2010 to 2.5 in 2050 to account for the fact that substitution is more likely in the long-term than in the short-term due to the lifetime of existing heating installations.

Elasticities of substitution for transport were taken from Vöhringer et al. 2013 and European Commission 1999. As gas and unrefined oil products that are transported by pipelines will not switch readily transport modes, the elasticities of substitution leading to Air and other transport are set to zero for the gas transport and distribution and refineries sectors.

All elasticities are set to the 2050 level for the years 2055-2070.

The intertemporal elasticity of substitution, which is the elasticity which governs how households are willing to substitute this year's consumption for that of another year, is set to 0.2.

Table 12: GENESWIS' elasticities of substitution

Nest	Sector	2010	2025	2050
KL	ETS	0.202	0.505	1.01
	MET	0.200	0.500	1.000
	ROI and all	0.237	0.594	1.189
KL,E	ROI	0.187	0.466	0.931
	ETS/MET	0.208	0.519	1.039
	AGR	0.103	0.412	0.927
	CMT	0.082	0.328	0.738
	GAS/DHT/RFU	0.051	0.204	0.459
	CON	0.106	0.424	0.954
	RLT/RDT/ATP	0.056	0.224	0.504
	ROS	0.091	0.364	0.819
ene	Household cons.	0.091	0.364	0.819
im	all	0		
eny	all	0.2		
hf	GAS/RFU/DHT	0		
	others	0.5	1.25	2.5
etp	RFU/GAS	0		
	Household cons.	1.3		
	others	2		
ptp	RFU/GAS	0		
	Household cons.	0.2		
	others	0.1		
ptl	all	0.5		
fel	RLT	0.2		
	ATP	none		
	others	10		

Table 13: GENESWIS' Armington elasticities, source: Hertel 1997 and Burniaux/Truong 2002

AGR	2.47
ETS	2.05
MET	2.2
CMT	2.8
CON	1.9
RLT	1.9
RDT	1.9
ATP	1.9
ROI	2.95
ROS	1.9
TFU	1.9
HFU	1.9
ELE	0
GAS	0
CRU	only imports
NUC	only imports
DHT	only domestic

2.3 GEMINI-E3

GEMINI-E31 (Bernard/Vielle 2008) is a multi-country, multi-sector, recursive computable general equilibrium model comparable to the other CGE models (EPPA, OECD-Env-Linkage etc.) built and implemented by other modeling teams and institutions, and sharing the same long experience in the design of this class of economic models. The standard model is based on the assumption of total flexibility in all markets, both macroeconomic markets such as the capital and the exchange markets (with the associated prices being the real rate of interest and the real exchange rate, which are then endogenous), and microeconomic or sector markets (goods, factors of production). In the last 20 years, GEMINI-E3 has been extensively used to assess future climate and energy strategies at global and regional levels.

The current version is built on the last GTAP database 8 (Badri et al. 2012). The industrial classification used in this study comprises 14 sectors and is presented in Table 14. The model describes five energy goods and sectors: coal, oil, natural gas, petroleum products and electricity. Concerning the regions represented by the model we use an aggregated version of GEMINI-E3 that describes only 6 countries/regions: Austria, France, Germany, Italy, Other European Countries and the Rest of the World.

Table 14: GEMINI-E3's industrial classifications

Sectors/goods	
01	Coal
02	Crude oil
03*	Gas
04	Petroleum products
05	Electricity generation
06	Agriculture
07	Metals
08	Energy intensive industries
09	Rest of industry
10	Construction
11	Land transport
12	Sea transport
13	Air transport
14	Services
15	Electricity transport and distribution

For each sector, the model computes the demand for its production on the basis of household consumption, government consumption, exports, investment, and intermediate uses. Total demand is then divided between domestic production and imports, using the Armington assumption (Armington 1969). Under this convention, a domestically produced good is treated as a different commodity from an imported good produced in the same industry. Production technologies are described using nested CES functions.

Time periods are linked in the model through endogenous real rates of interest determined by equilibrium between savings and investment. National and regional models are linked by endogenous real exchange rates resulting from constraints on foreign trade deficits or surpluses.

2.3.1 Production

The production structure of the industrial sectors is shown in Figure 39.

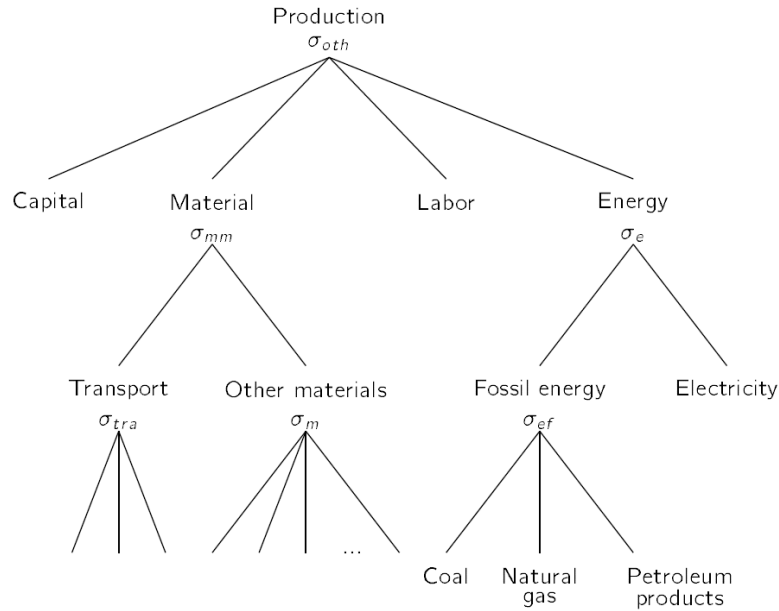

Figure 39: Nested CES production structure of industrial and services sectors

2.3.2 Consumption

Household's behavior consists of three interdependent decisions: 1) labor supply; 2) savings; and 3) consumption of the various goods and services. In GEMINI-E3, we suppose that both labor supply and the rate of savings are exogenous. Demand in the different commodities has prices of consumption and income (more precisely "spent" income, income after savings) as arguments and is derived from a utility function whose specifications are a Stone-Geary (Stone 1954) or Linear Expenditure System (LES):

$$u_r = \sum_i \beta_{ir} \cdot \ln(HC_{ir} \cdot e^{\theta_{ir}^h \cdot t} - \phi_{ir}) \quad (2.3.1)$$

Where ϕ_{ir} represents the minimum necessary purchase of good i , β_{ir} corresponds to the marginal budget share of good i and θ_{ir}^h a technical progress on the household consumption of good i .

Maximization under budget constraint where HCT_r represents the total expenditure for households consumption, and where PC_{ir} is the consumption price of good i , gives the demand function:

$$HC_{ir} = \frac{\phi_{ir}}{e^{\theta_{ir}^h \cdot t}} + \frac{\beta_{ir}}{PC_{ir}} \cdot \left[HCT_r - \sum_k \left(\frac{PC_{kr} \cdot \phi_{kr}}{e^{\theta_{kr}^h \cdot t}} \right) \right] \quad (2.3.2)$$

2.3.3 Baseline calibration

The baseline scenario was based on the following quantities:

- labor supply,
- GDP growth,
- energy prices.

For European countries/regions (Austria, Germany, Italy, France and other European countries) we used the figures coming from “The 2012 Ageing Report” published by the Directorate-General for Economic and Financial affairs (European Commission 2011b). The assumptions of the ROW regions are drawn from the World Energy Outlook (WEO) 2010 (IEA 2010) and from the World Population Prospects done by the United Nations (United Nations 2011). Finally international energy prices are calibrated from those given by the WEO 2011.

Table 15 gives the GDP growth by countries/regions.

Table 15: GDP growth (average yearly GDP growth rate)

	2007-2020	2020-2030	2030-2040	2040-2050
Austria	1.3%	1.3%	1.4%	1.4%
Germany	0.8%	0.7%	0.6%	0.8%
Italy	0.4%	1.4%	1.2%	1.3%
France	1.2%	1.8%	1.6%	1.6%
OEU	1.4%	2.0%	1.7%	1.5%
ROW	5.1%	3.3%	3.1%	2.9%
World	4.1%	3.0%	2.8%	2.6%

Table 18 (page 79) shows the international energy prices; we retain the current policies scenario. As the predictions of the International Energy Agency stop in 2035, we assume that the energy prices will continue to slowly increase after 2035. The oil price is assumed to reach 157.9\$ per barrel in 2050 and the price of imported gas in Europe is equal to 14.7\$ per Mbtu in 2050.

2.3.4 International climate policy scenarios

In this section, we describe the international scenarios that have been simulated in the project. The definition of these scenarios is mainly based on the *EMF22 MiniCAM – BASE* scenarios (see Calvin et al. 2009; Clarke et al. 2008). We have simulated three scenarios:

1. **A Reference scenario.** In this scenario, no climate policy is implemented since it serves to evaluate the cost of the climate policies scenarios.
2. **A Baseline scenario.** For this scenario, the MiniCAM scenario S1_3p7_OS was selected as a starting point. To account for existing policies in the EU to 2050, the allocation of the global emissions trajectory was adjusted to match the estimated emissions in the EU under “Current Policy” as defined in the EU Roadmap (European Commission 2011a). For Switzerland, the baseline scenario is comparable to the *weiter wie bisher* scenario of the Energy Perspectives.

3. **A Moderate stringency scenario.** The global emissions trajectory in MiniCAM scenario S1_3p7_S was selected as consistent with more ambitious Swiss policy to 2050. To account for additional abatement activity in the EU, this global trajectory was adjusted to match the additional nearer-term (to 2030) EU Roadmap emissions pathway (European Commission 2011b), but not the more normative/aspirational 2050 EU mitigation goals.

The emissions trajectories for the EU and the rest of the world are presented in Figure 40. For the EU, the abatements in 2050 with respect to 2010 levels are respectively equal to 33% and 53% in the baseline scenario and in the moderate stringency scenario. It must be noticed that our baseline scenario is close to the Primes reference scenario published in 2013. For the Rest of the world, the abatements are less important in 2050 with respect to 2010 levels and equal to 13% and 28%. But if we compute the effective abatement with respect to our baseline scenario, the reductions are much more significant and equal to 43% and 64%.

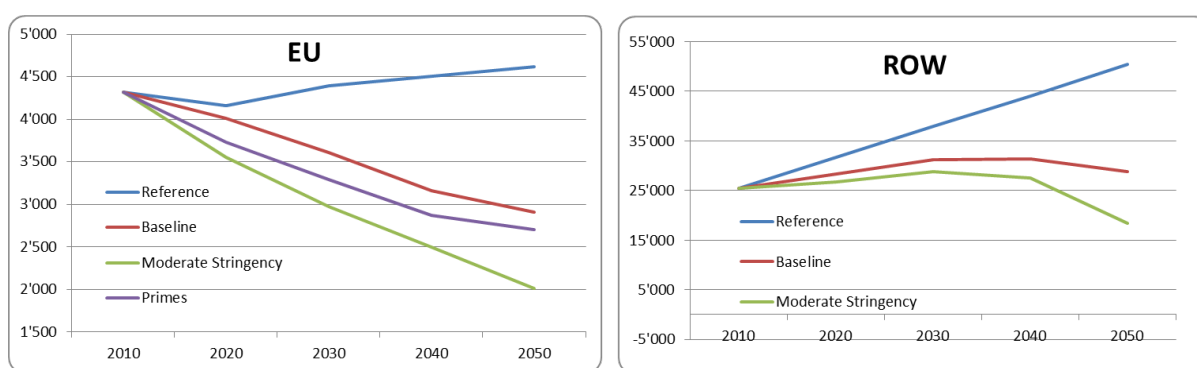

Figure 40: Emissions trajectories for the EU and the Rest of the world in Mt CO₂

The mitigation scenarios are implemented through a uniform CO₂ price that is derived from a world-wide emissions trading system that takes the emissions profiles presented above as initial allocations. For European countries/regions (Austria, Germany, Italy, France and Other European Union countries), the EU budget is allocated to each Member State by taking into account their emissions in the reference scenario: i.e. the more you emit, the more allocations you receive. We assume that only CO₂ emissions are taxed and the extra revenue (positive or negative) from the exchanges is redistributed by each region to their households through a lump sum transfer.

2.3.4.1 The Baseline scenario

Table 16 gives the CO₂ price in € computed by GEMINI-3, Figure 41 shows the emissions trading and welfare impact in % of households consumption in 2050. The CO₂ price would reach 55 € per ton of CO₂ in 2050. This moderate price is mainly driven by the low mitigation costs of the Rest of the world that is a significant net exporter of permits (up to 600 million ton of CO₂ in 2040) in this scenario. The welfare cost is measured in the GEMINI-E3 model by the households' surplus and can be decomposed in three components:

1. The Gains or losses from the Terms of Trade (GTT) representing the spill-over effects due to changes in international prices. Under climate policy, these gains or losses from the terms of trade mainly come from the drop in fossil energy prices due to the decrease of world energy demand;
2. The buying or selling of tradable permits (called "Trading" in the figures);

- By subtracting the GTT and Trading from the Welfare we obtain the Deadweight Loss of Taxation (DWL), i.e. the domestic cost that would occur in a closed economy and which only depends on the abatement done within the country.

Table 16: CO₂ price in € - Baseline scenario

	2020	2030	2040	2050
CO₂ price	6	12	24	55

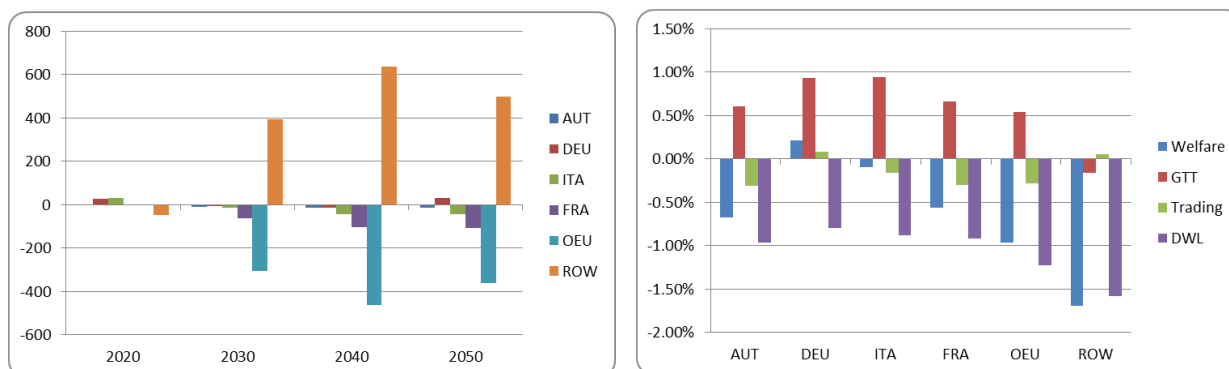

Figure 41: Emissions trading in Mt CO₂ (left) and welfare impact in % of household consumption in 2050 (right) – Baseline scenario

These three components are presented in Figure 41 for the year 2050. The welfare impact is slightly positive for Germany coming from a significant GTT and an initial CO₂ allocation which is quite generous. For the other countries/regions the welfare impact is negative. The EU countries are net importers of emissions permits (except Germany) and the ROW net exporter. ROW is the most affected region (with a welfare cost equal to 1.5% of household consumption), their initial CO₂ allocation is not sufficient to counterbalance their DWL.

2.3.4.2 The Moderate stringency scenario

In the *Moderate stringency scenario* the CO₂ price reaches 170 € per ton of CO₂. Of course, this higher price is associated with more important welfare losses. In 2050, the welfare loss is equal to 6% of household consumption for the Rest of the world. The cost for European countries is less important and equal to around 4%. Again, Germany is the least affected EU region with a welfare loss equal to 1.7% of household consumption. The Rest of the world remains net exporter of tradable permits, even if these exchanges decrease at the end of the simulation period.

Table 17: CO₂ price in € - Moderate stringency scenario

	2020	2030	2040	2050
CO ₂ price in €	10	19	43	170

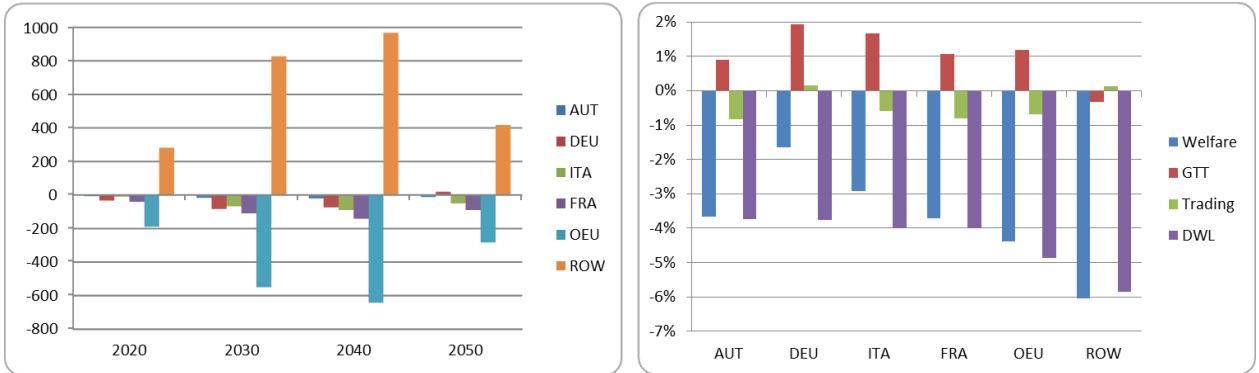

Figure 42: Emissions trading in Mt CO₂ (left) and Welfare impact in % of Household consumption in 2050 (right) – Moderate stringency scenario

Figure 43 shows the energy consumption by fuel for the 4 individual EU countries (Austria, Germany, Italy and France) in the Moderate stringency scenario. The variations of energy consumption are quite similar among the four countries. Total energy consumption decreases by 29% to 39%. Coal, which is mostly used in electricity generation, decreases by 82%. Only Germany still continues to use this energy in electricity generation. Of course, this result would not be the same, if CCS technology had been taken into account for electricity generation in GEMINI-E3. Other fossil energy consumptions (i.e. natural gas and refined petroleum products) are less affected by the carbon price and faced to the same dynamic. Indeed, their consumptions decrease in 2050 by 33% in average for the 4 individual EU countries. Finally, the decrease of electricity consumption is limited and equal in average to 15%.

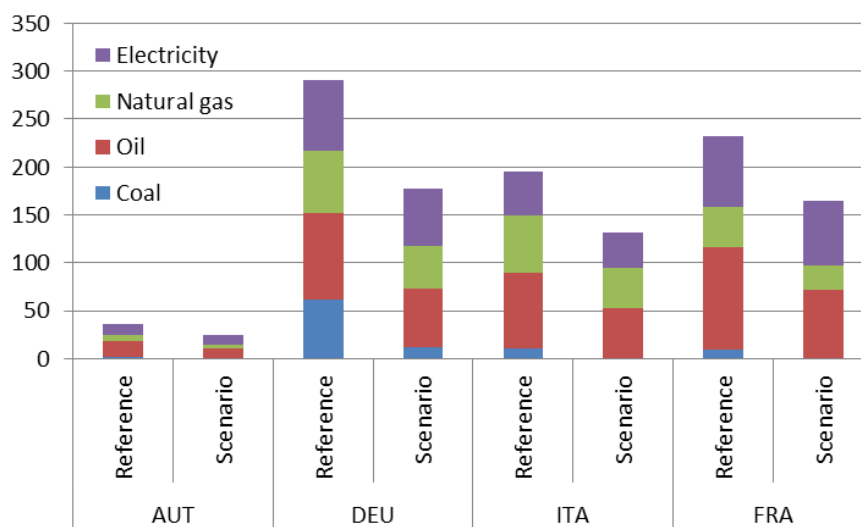

Figure 43: Energy consumption by fuel in Mtoe year 2050 – Reference and Moderate stringency scenarios

Table 18: International energy prices (US Dollar per unit, 2010 prices)

	2010	2020	2030	2040	2050
IEA crude oil imports (barrel)	78.1	118.1	134.5	145.7	157.9
European gas imports (MBtu)	7.5	11.0	12.6	13.4	14.7
OECD steam coal imports (tonne)	99.2	109.0	115.9	121.0	126.2

The baseline scenario assumes that **no climate policies are implemented** except those that have been implemented before year 2007.

3 The coupled ELECTRA frameworks

3.1 ELECTRA-CH: Coupling CROSSTEM-CH and GENESWIS

3.1.1 Coupling methodology

3.1.1.1 Overview

We built a coupled bottom-up top-down framework that consists of two models: the technology-rich bottom-up model Cross Border TIMES Electricity Model (CROSSTEM- CH), and the dynamic multi-sectoral (Computable) General Equilibrium Model of the Swiss economy (GENESWIS). These two models are coupled through an iterative soft link, where

- the electricity generation production function in the computable general equilibrium (CGE) model is determined by the cost structure optimized by the bottom-up model;
- the sectoral electricity demand variations, which occur in the CGE as a result of changes in prices, as well as factor and intermediate input price variations are sent back to the bottom-up model.

When choosing the soft link approach, we were fully aware of the advantages and disadvantages of different coupling methods as described in the literature. A lot of effort has been devoted to developing and assessing coupling methods since the first coupling by Hoffman and Jorgenson 1977. Two main currents emerge: "hard linking", which encompasses the two model types into one single model, and "soft linking", which couples existing full-size models by exchange of variables (Wene 1996).

The hard linking methodology may be implemented by enhancing one model with a reduced version of the other (Manne and Wene 1992; Messner and Schratzenholzer 2000; Kombaroglu and Madlener 2003; Wing 2006; Böhringer and Rutherford 2008), by writing a hybrid model directly in MCP format (Böhringer and Rutherford 2008; Frei et al. 2003), or by decomposing an MCP hybrid model and solving it iteratively (Böhringer and Rutherford 2009; Sugandha et al. 2009; Lanz and Rausch 2011).

This methodological choice ensures consistency within the model, but does not permit a high level of detail in both technical specification and economic interactions.

The "soft link" coupling method (Drouet et al. 2005; Schäfer and Jacoby 2005; Martinsen 2011; Sceia et al. 2012; Riekkola et al. 2013; Fortes et al. 2014) involves keeping the models' full structure and complexity, exchanging a chosen set of variables and solving the models iteratively until convergence is reached on a given criterion. It has the advantage to permit the use of full-scale models with all their dimensionally and complexity. However, Böhringer and Rutherford 2009 warn of the dangers of inter-model inconsistencies and convergence issues when soft-coupling models with fundamentally different logics.

To analyze electricity markets in Switzerland, we choose the "soft link" method. Similarly to Schäfer and Jacoby 2005 (for transportation), we deemed important to adequately model the electricity sector's interaction with the other sectors of the economy. Moreover, as electricity is a very specific commodity, a careful and detailed modeling of time-periods, load-curves and technological poten-

tials were considered crucial. In addition, a precise implementation of both market policies and technological restrictions was required.

Coupling through a soft link prioritizes the strengths of each model: The electricity generation mix and costs from the bottom-up model are given priority over the electricity production function of the CGE model. The latter effectively becomes a Leontief function which is parameterized with information from the latest bottom-up run. On the other hand, the endogenous electricity demand reaction of the top-down model is given precedence over the initial demand assumption for the electricity supply model. Additionally, the variations of factor and intermediate input price variations due to general equilibrium effects modify the investment costs and operation & maintenance costs of the bottom-up model.

Figure 44 depicts the exchange of information between the two models. Electricity generation costs and their components as well as export revenues and import costs are extracted from the CROSSTEM-CH model and translated for the CGE model into a) the wholesale electricity price and b) input shares for factors and commodities to the electricity generation cost function. The sectoral²² electricity demand quantities simulated by the GENESwIS model are then sent back to become inputs to the CROSSTEM-CH model. To account for changes in the economy, factor and intermediate input prices from GENESwIS are used to modify the investment costs and operation and maintenance costs of the different technologies in the bottom-up model. This sequence is iterated upon until the vector of quantities of total electricity demanded each year converges.

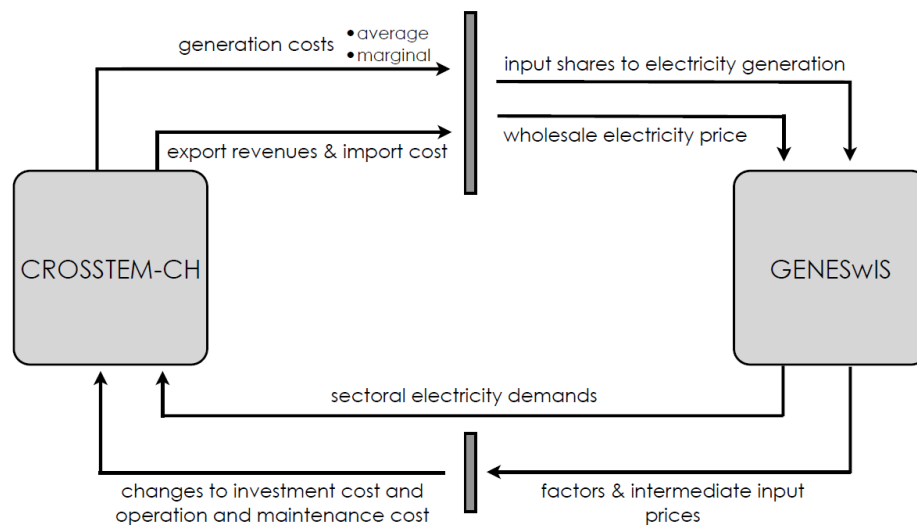

Figure 44: Information exchange between the two component models within one iteration.

3.1.1.2 Coupling structure

The two models are coupled through a coupler, written in the Python language, which displays the following (simplified) structure:

As long as the demand doesn't reach a given convergence criterion:

²² GENESwIS simulates yearly electricity demands which are distributed to each of the 288 time slices of the CROSSTEM-CH with the help of sectoral load curves.

- Run the CROSSTEM-CH model, read the result file, extract the different costs, and generate an input file for the GENESwIS model.
- Run the GENESwIS model, read the result file, extract the sectoral demands and price changes, and convert them to input for the CROSSTEM-CH model.

We start by running the bottom-up model CROSSTEM-CH. For the *Baseline scenario*, both models are calibrated and harmonized such that the electricity demand follows the projected path from Prognos 2012. Hence, there would be no need to run GENESwIS first, as the electricity demand from a first run of the CGE model would be the same as the initial demand input from the CROSSTEM-CH model.

3.1.1.3 CROSSTEM-CH input into GENESwIS

The goal of a soft-link coupling methodology is to prioritize the strengths of each model. As such, the bottom-up model's information on electricity generation must be prioritized over the CGE model's electricity generation production function. Hence, the following information from CROSSTEM-CH will be prioritized over GENESwIS's:

- technology mix in electricity generation,
- cost of electricity generation,
- electricity trade.

The CGE model does not encompass the large amount of different technologies inherent to the bottom-up model: The electricity mix cannot be plugged-in as such in GENESwIS. Translation mechanisms and modifications of the GENESwIS model are therefore needed for this information to be understood and prioritized over the usual structure of the CGE model. Also, although generation costs can be inserted into the model, this does not imply that prices would be fixed in GENESwIS.

3.1.1.3.1 Modifications of the GENESwIS model

For the information given by the bottom-up model CROSSTEM-CH to be treated as direct input, the electricity generation production function of GENESwIS is set as a Leontief function. This way, no substitution is allowed within one model run between inputs, which are set as fixed shares. The shares do, however, change between iterations during the coupling process.

The input shares define the technology of electricity production in a CGE model. This cannot be seen as a technology mix as such, as no differentiation is made between the different bottom-up technologies (i.e. solar pv, storage hydro, offshore wind etc.), but gives the ratio of different commodities needed to produce an average PJ of electricity (amount of machinery, operation and maintenance, gas, nuclear fuel etc.). A change in technology mix, say introduction of gas-fired power plants, will be felt through mainly an increase of the share of gas in the CGE production function, and maybe a shift in share of capital and operation and maintenance costs.

The different costs of electricity production calculated in the bottom-up model are translated into inputs from commodities defined in the CGE model. Namely, gas costs, nuclear fuel costs, capital costs, operation and maintenance costs, inter-connector costs, import costs and export revenues. The nesting structure of the ELE production is represented on Figure 45.

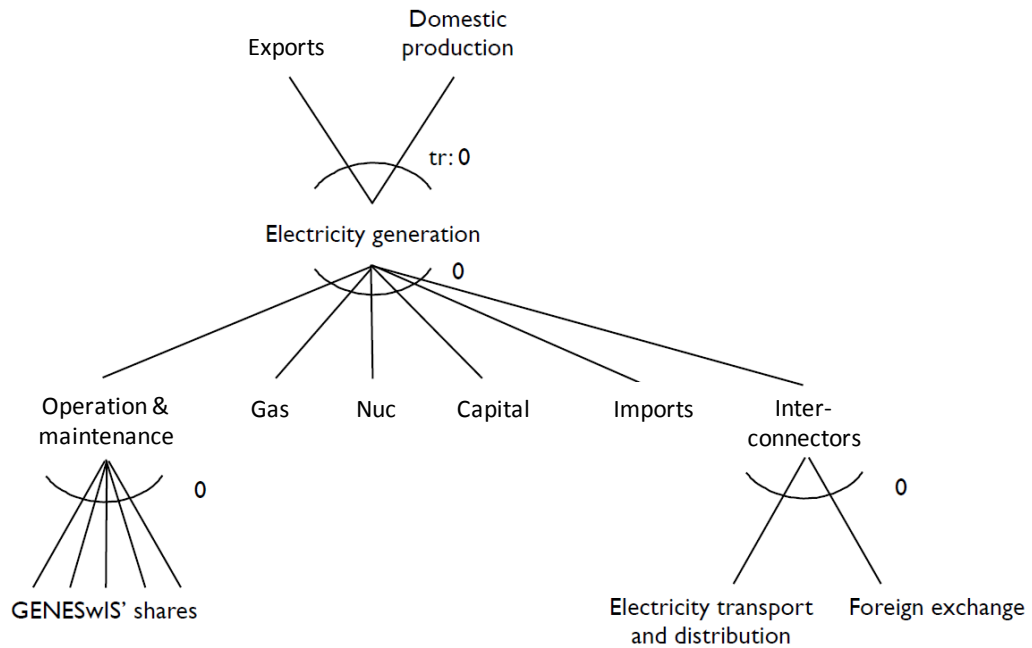

Figure 45: Nesting structure of GENESwIS' electricity generation production function. The labels in bold-green represent inputs from the CROSSTEM-CH model.

Operation and maintenance costs are not disaggregated into labor, materials, and other costs in the CROSSTEM-CH model. To retain sectoral information, we preserve the shares specified in the input-output table for electricity production. Operation and maintenance is hence defined as a sub-nest composed of all inputs initially entering the ELE production function except for imports, natural gas, nuclear fuels and capital.

The CROSSTEM-CH model does not precisely represent transport and distribution costs within the country of production. We therefore keep the electricity transport and distribution (ETD) sector in GENESwIS with the technology given by the Swiss Input-Output Table. However, the electricity balance equation in CROSSTEM-CH includes trade and inter-connectors (international transportation). For coherence, these inputs are included in the ELE production function instead of the ETD production function of the GENESwIS model. Inter-connectors are assumed to be owned partly by the Swiss ETD sector and by the neighbouring country (50%-50%). Inter-connector costs are hence paid to ETD and to foreign exchange (see Figure 45).

3.1.1.3.2 Link CROSSTEM-CH's costs to GENESwIS' electricity generation and price

The electricity generation technology is determined by CROSSTEM-CH's input cost shares.

For the wholesale electricity price, things are more complex. The wholesale electricity price cannot be plugged directly into the CGE as prices cannot be fixed. However, the Electricity Generation (ELE) price in the CGE can be pushed to a given value by varying the inputs of the production function while keeping output constant.

Let us assume the following Leontief electricity production function (output value is equal to input costs):

$$P_{ELE}(t) \cdot Y_{ELE}(t) \cdot q_{ELE}(t) = \text{MIN}\left\{\sum_i P_i(t) \cdot Y_{ELE}(t) \cdot q_i(t)\right\} \quad (3.1.1)$$

where $P_{ELE}(t)$ is the price of electricity, $P_i(t)$ the prices for the different inputs, $Y_{ELE}(t)$ the activity index variable of the electricity generation production function, and $q_{ELE}(t)$ and $q_i(t)$ the quantity parameters for respectively electricity generation and the different inputs. We assume benchmark prices to be set to one, which allows us to treat the quantity parameters as values. For the ease of explanation, and because in a general equilibrium all markets are in equilibrium, we will henceforth drop the "minimum" in equation (3.1.1).

We set $q_{ELE}(t)$ as a constant parameter. Consequently, equation (3.1.1) implies that a variation of $q_i(t)$ impacts the price variable of electricity $P_{ELE}(t)$. The goal of the exercise is to calculate the $q_i(t)$ parameters, given CROSSTEM-CH's costs $CC_i(t)$, such that the $q_i(t)$ push the price of electricity generation, $P_{ELE}(t)$, to reflect CROSSTEM-CH's total costs divided by the electricity demand. Accordingly, we want:

$$\begin{aligned} P_{ELE}(t) &= \frac{\sum_i CC_i(t)}{\text{electricity demand}} \\ &= \frac{\sum_i CC_i(t)}{Y_{ELE}(t) \cdot q_{ELE}(t)} \end{aligned} \quad (3.1.2)$$

Plugging (3.1.2) into (3.1.1), we obtain that the input quantities $q(i)$ must be calculated the following way:

$$q_i(t) = \frac{CC_i(t)}{P_i(t) \cdot Y_{ELE}(t)} \quad (3.1.3)$$

All price and quantity indices constantly vary in the GENESwIS model between iterations within one simulation. It is therefore not possible to calculate the $q_i(t)$ within GENESwIS, using current prices and indices. To calculate the $q_i(t)$, we must take input prices $P_i(t)$ and electricity activity index $Y_{ELE}(t)$ from the previous iteration of GENESwIS. For the sake of precision, let us rewrite equation (3.1.3) for iteration number k :

$$q_{i,k}(t) = \frac{CC_{i,k}(t)}{P_{i,k-1}(t) \cdot Y_{ELE,k-1}(t)} \quad (3.1.4)$$

Although previous iteration prices might differ from present prices, once the framework converges, the input prices converge as well. As the convergence criterion is set on electricity demand, the electricity production index $Y_{ELE}(t)$ is bound to have converged, as demand always equals supply in a CGE model.

By calculating the input quantities this way, the price of electricity generation $P_{ELE}(t)$ reflects the average cost (AC) of the CROSSTEM-CH model. This is fine when assuming a regulated wholesale electricity market. However, the Swiss wholesale electricity market is already partly liberalized and is expected to be liberalized further in the coming years. A liberalized market asks for electricity to be priced at marginal cost (including scarcity rents) and not average cost.

Although we do not know exactly how the wholesale electricity market will develop, assumptions about future market structure have an impact on modeling results, which we investigate in Maire et al. 2015, a draft of which can be found in section 3.1.2.

We assume for this study a progressive evolution to a fully liberalized market, where prices are formed through marginal cost pricing: from 2025, the market is fully liberalized and the market price equals the long-term marginal cost of the CROSSTEM model; in 2010, the price is given by the Input-Output data and reflects the current situation while in the years in between, the market is increasingly liberalized and prices reflect a combination of regulated prices and marginal cost pricing (see Figure 46).

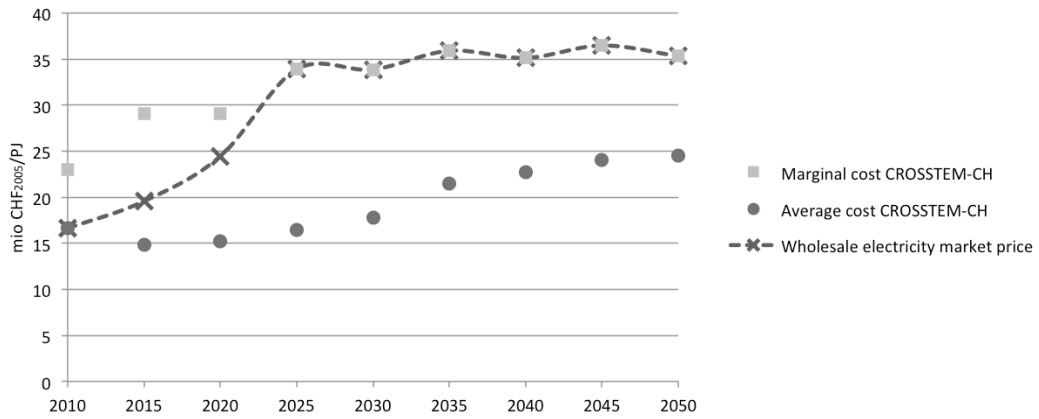

Figure 46: Wholesale electricity market price in comparison with average cost and marginal cost from the CROSSTEM-CH model, assuming progressive evolution to full market liberalization.

In order for the price in GENESwIS to reflect the wholesale electricity market price and not only average cost, profit is introduced in the electricity generation production function. It is modeled as an output tax on electricity production; the tax rate being set such that it will inflate the CGE electricity generation price from the average cost given by the CROSSTEM-CH model (AC) to the assumed market price (P_m).

$$\text{Profit}(t) = \frac{P_m(t) - AC(t)}{P_m(t)} \quad (3.1.5)$$

with the following assumptions: $P_m(2010) = \text{IOT price}$, $P_m(2015) = \frac{2}{3} \cdot AC + \frac{1}{3} \cdot MC$, $P_m(2020) = \frac{1}{3} \cdot AC + \frac{2}{3} \cdot MC$, and $P_m(\geq 2025) = MC$.

CROSSTEM-CH optimizes the total cost of electricity generation and trade over the full period 2010 to 2050. The marginal cost calculated by the model is the shadow price of the commodity balance and represents the increase in the total cost of the system due to an increase of a unit of demand (Loulou et al. 2005). It includes all constraints and costs (incl. investment costs) and can therefore be seen as a long-term marginal cost, or marginal cost including scarcity rents. As the CGE model's simulates a year and not each 288 time slices displayed in the bottom-up model, the marginal cost is converted to an annual demand-weighted marginal cost (MC). MC is thus calculated as in equation (3.1.6):

$$MC = \frac{\sum_{ts} D_{ts} \cdot MC_{ts}}{\sum_{ts} D_{ts}} \quad (3.1.6)$$

where D_{ts} is the demand at time-slice ts , and MC_{ts} the marginal cost for time-slice ts .

3.1.1.4 GENESwIS input into CROSSTEM-CH

3.1.1.4.1 Demand

Yearly sectoral electricity demands are extracted from GENESwIS and given as inputs to the CROSSTEM-CH model. GENESwIS' yearly electricity demand is converted to demands for the 288 time slices of the CROSSTEM-CH model with the help of load curves. Electricity demand is differentiated by GENESwIS for 5 types of sectors: agriculture, industry, transports, services and households to allow for introduction of sectoral load-curves.

To help with convergence, the electricity demand response of the GENESwIS model is not sent directly, but dampened (see further below).

Electricity demands for 2010 are not exchanged. Due to the calibration to *weiter wie bisher* projections and to the intertemporal behavior of the model, we experience some border effects that are not desirable in 2010. It is hence not instructive to couple 2010 values and historical values are kept unchanged.

3.1.1.4.2 Factor and input prices variation

For the sake of consistency, we try to include, to the extent possible, price feedback into the bottom-up model. Indeed, in the CGE model, factors, goods and commodity prices vary in response to the different scenarios. However, CROSSTEM-CH does not use prices, but cost data on operation and maintenance, investments and fuels. Fuel costs are set exogenously for both models as Switzerland does not have an impact on world prices. However, for other costs, the variations of domestic prices should be taken into account. For this purpose, we send sectoral price variations to modify investments and operation and maintenance (O&M) costs for the different technologies. To do so, we create price-variation coefficients. These coefficients are composed of the weighted average of the price variation of each sector; the weighting being equal to the share of expenditure into each sector. However, investment and O&M costs of the CROSSTEM-CH model are not disaggregated into shares of different cost components (i.e. labor, metals, cement etc.). We must therefore take some assumptions on the composition of these costs.

We class the different production technologies into four main groups: hydro generation, thermal generation, solar PV, and other renewable technologies.

The decomposition of investment costs was based mostly on Ragwitz et al. 2009, with modifications from additional communication between the project partners. The price variation coefficients are calculated as the weighted average (weights given in Table 19) of the price variation of each input compared to the benchmark prices. In GENESwIS, transport sectors are disaggregated between Road, Rail, and Air and Other transport. The transport price coefficient is therefore composed of a combination of the different transport sectors prices using Swiss input-output table shares of intermediate consumption of transportation by the electricity generation (ELE) sector.

Table 19: Composition of the price variation coefficients modifying CROSSTEM-CH's Investments costs per technology

	ROI	ETS	MET	CON	ROS	Transport
Thermal plants	61%	1%	9%	10%	7%	13%
Hydro plants	45%	0%	5%	27%	19%	4%
Solar PV	42%	16%	30%	1%	2%	9%
Other renewables	56%	0%	24%	12%	4%	3%

Operation and maintenance (O&M) costs include labor costs and material and other service costs. Labor shares were estimated by Hal Turton for an analysis in the EU-NEEDS project. The other sectors' shares are computed from the Energy Input-Output Table (Nathani et al. 2011). As transport is considered here only for thermal plants, it is considered to be composed solely of pipeline transport, included in the Air and Other transports (ATP) sector.

Table 20: Composition of the price variation coefficients modifying CROSSTEM-CH's Operation and maintenance costs per technology

	Labor	ROI	ETS	MET	CON	ROS	Transport
Thermal plants	10%	47%	0%	0%	3%	38%	2%
Hydro plants	80%	2%	0%	1%	3%	13%	0%
Solar PV	50%	7%	1%	2%	11%	28%	0%
Other renewables	50%	7%	1%	2%	11%	28%	0%

3.1.1.5 Harmonization and convergence

The first main challenge when soft coupling two models of different natures such as GENESwIS and CROSSTEM-CH is for the models to react in a reasonable and stable way to the coupling. Indeed, input values that vary too much from the values the models are used to receive can lead to solution problems. For example, a too high electricity demand might push the CROSSTEM-CH model to reach boundaries of generation potentials. It then must use stop-gap production technologies with very high costs, that prevent the model from becoming infeasible. These very high costs, when sent to the GENESwIS model, which bring the electricity demand down drastically. When sent back to CROSSTEM-CH, a very low demand might, for example, result in CROSSTEM-CH generating negative costs due to the trade revenues. Negative costs are not allowed in the GENESwIS model, and solving the framework becomes impossible.

Hence, a careful harmonization of the models is necessary before attempting the coupling and hoping for meaningful results (see 3.1.1.5.1).

The second main challenge is to reach convergence. First of all, a solution must exist for the framework to converge to. With such a complex framework, it was not possible to check this mathematically prior to testing. CGE models are built on CES functions to ensure convexity and solvability. However, it was not possible to determine the solution space of two big models with different structures and logic. When solutions do exist for all the scenarios simulated, the framework must converge to the existing solution.

Convergence is not easy to achieve due to the stepwise behavior of the bottom-up model. Special solving techniques (see sections 3.1.1.5.2 and 3.1.1.5.3) had to be applied in the coupling procedure

to avoid the framework getting locked in oscillations. Finally, once convergence on electricity demand is reached, a check on convergence of other important variables is required for consistency.

3.1.1.5.1 Harmonization of the models

For the models to accept each other and converge to meaningful solutions, they must be harmonized carefully.

For exogenous data, harmonization is trivial. A discount rate of 4.5% was decided upon and used in both models. World energy prices (import prices) and CO₂ permit prices for the Emissions Trading Scheme were set for both models (see Table 11, page 70).

Endogenous variables are much more difficult to harmonize while keeping the structure and data consistency of each models.

The first difficulty encountered was linked to the electricity pricing and costs of electricity production. GENESwIS is based on the Swiss Input-Output Table (IOT) (Nathani et al. 2011). This input-output table also includes information on energy prices. It is important to ensure that average cost (AC) and marginal cost (MC) of electricity from the CROSSTEM-CH model (in terms of annual averages) are reconciled with IOT prices. Also, to ensure economic consistency, average annual marginal cost should not be smaller than annual average cost in any given year. For this purpose, some input data in the CROSSTEM-CH model were modified. Especially, capital costs for existing plants were included in generation costs.

Once average and marginal costs from the CROSSTEM-CH were reconciled with IOT prices, demands had to be aligned for the baseline.

The baseline scenario for this work is based on the *weiter wie bisher* scenario of the Energy Perspectives 2050 (Prognos 2012). Hence, CROSSTEM-CH initial demands are set on the demand projections of Prognos 2012 for the *weiter wie bisher* scenario. For the total framework to be set on that same *Baseline scenario*, GENESwIS was re-calibrated along that demand path, with the input of CROSSTEM-CH's electricity price.

3.1.1.5.2 Supply elasticity

To help with the convergence of the models, which is hampered by the stepwise behavior of the bottom-up supply curve, we introduce a supply elasticity in the Electricity Transport and Distribution sector of GENESwIS. For this purpose, we insert a fixed resource at the top of the Electricity transport and distribution nest (see Figure 47). The elasticity of substitution between the fixed resource and the rest of the inputs is calculated as per equation 3.1.6 given a supply elasticity η and the share of fixed resource ϑ_R (see Rutherford 1998).

$$\sigma = \eta \frac{\vartheta_R}{1 - \vartheta_R} \quad (3.1.6)$$

The value of supply elasticity can be set such that it helps with convergence (approximating the bottom-up supply elasticity), as it has no impact on the results. For our simulations, we set the supply elasticity at $\eta=2$. With $\vartheta_R= 0.024$, equation (3.1.6) gives us an elasticity of substitution of $\sigma=0.05$.

This method was prompted by the work of Lanz and Rausch 2011 who introduce a demand elasticity to parametrize the bottom-up demand. They show that the choice of demand elasticity does not affect the results but that a good approximation of the top-down demand response reduces the number of iterations needed for convergence.

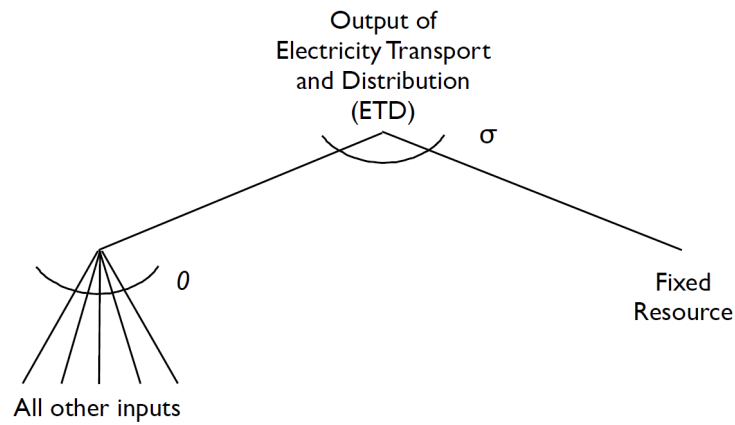

Figure 47: Nesting structure of the Electricity transport and distribution production function in GENESwIS.

3.1.1.5.3 Dampening the demand response

Due to the stepwise nature of the bottom-up supply curve, and despite the introduction of a supply elasticity in the electricity transport and distribution of the CGE model, it is frequent that the models lock up into an oscillation between two marginal costs. The electricity demand oscillates between two values and does not converge. To avoid this problem, we introduce a dampening of the demand response between sub-sequent iterations into the coupler. Instead of sending the sectoral demands from the CGE directly to the bottom-up model, we send a Gauss-Seidel combination of the whole history of demands as on equation 3.1.7.

$$D_{i+1} = \alpha D_i + (1 - \alpha) D_{i-1} \quad (3.1.7)$$

The calibration of the α parameter is sensitive. Taking too small steps increases the run time, when too large steps will not solve the problem of the oscillations. We found that $\alpha=0.3$ is a good choice for our framework. However, for some difficult scenarios, when many different marginal technologies compete, the α had to be decreased after some initial iterations.

Figure 48 gives an illustration of the demand-dampening (Gauss-Seidel method) for our framework. The representation is indeed merely an illustration, because the depicted supply and demand curves are much too simplistic.

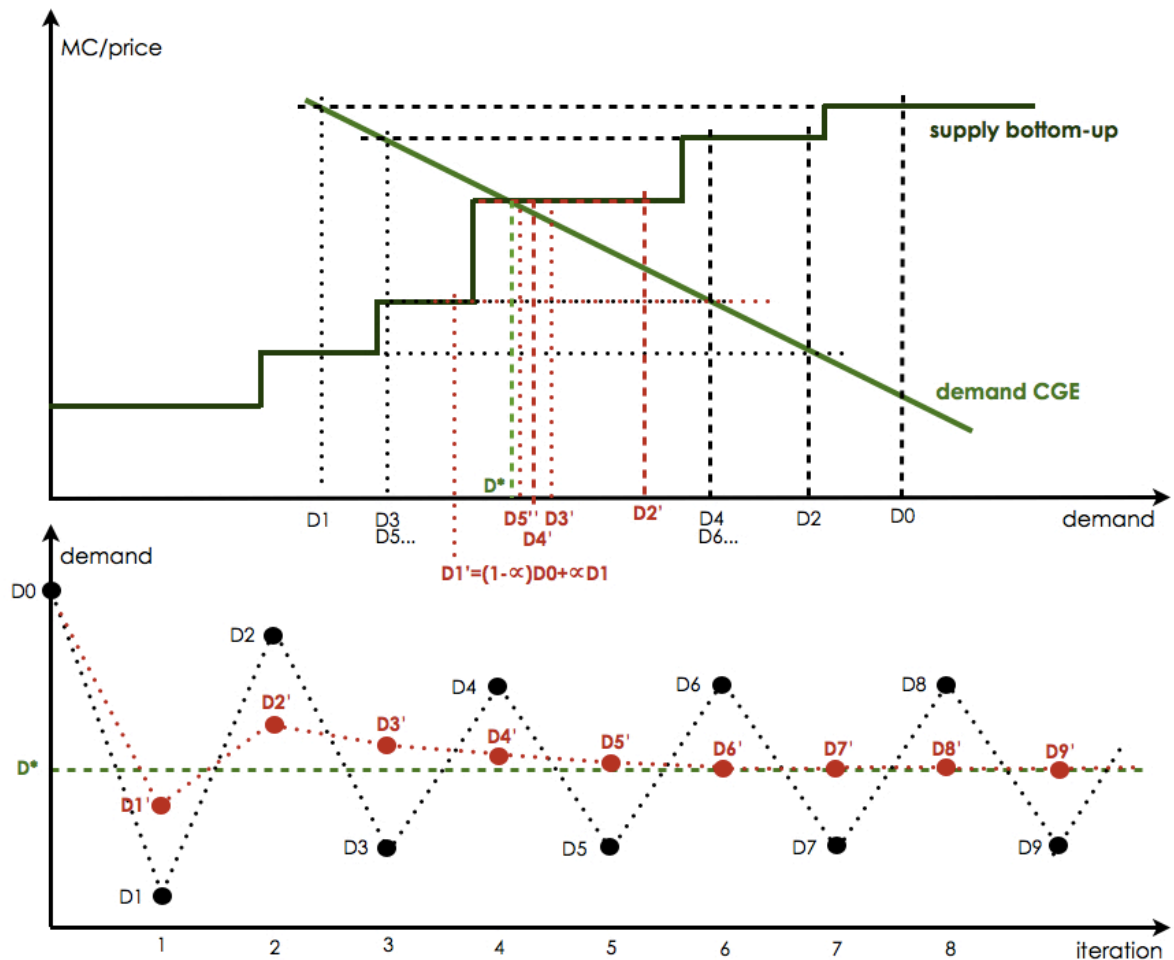

Figure 48: Illustration of the demand-dampening (Gauss-Seidel) method for our framework.

Let us assume a bottom-up step-wise supply function and a demand curve for the CGE model. The equilibrium solution lies at demand D^* . The goal for the coupling framework is to converge to this solution. Let us start with demand D_0 . The bottom-up model optimizes the electricity supply system and provides the CGE model with a given marginal cost (wholesale price). With this information, the CGE model reaches equilibrium at demand D_1 . D_1 is then sent to the bottom-up model. With D_1 for input, a much lower marginal cost is reached, which, sent to the CGE, will give a solution at D_2 . This routine is performed until convergence is reached. However, with this configuration, the framework never converges. It stays stuck, oscillating between 2 solutions (D_3 and D_4) indefinitely.

This is when the Gauss-Seidel method becomes useful. Let us start with the same initial demand D_0 . The demand sent to the bottom-up model (D_1' , in red ink in Figure 48) is a combination of the previous demands (equation 3.1.7). The same dampening is applied to the next demands. This way the steps are reduced, and the framework does not get stuck between two states. It is, hence able to converge towards the solution D^* .

The demand-dampening approach does not influence the equilibrium, but merely helps to approach the solution in a smoother way.

3.1.1.5.4 Convergence criterion

The coupling procedure iterates until the electricity demand converges. To test this convergence, the following criterion ζ is introduced:

$$\zeta = \frac{\sqrt{\sum_t (D_{t,i} - D_{t,i-1})^2}}{\sqrt{\sum_t D_{t,i}^2}} \quad (3.1.8)$$

where $D_{t,i}$ stands for the electricity demand at period t for iteration i .

Although ζ is the stopping criterion (set at $5 \cdot 10^{-5}$) for the coupling procedure, we verify post-simulation that convergence has been reached for other variables (marginal cost, average cost, sectoral output etc.). Table 21 displays some information on the convergence of a few variables for the three domestic scenarios simulated with the ELECTRA-CH framework.

Table 21: Convergence of the ELECTRA framework for the three scenarios simulated: a few indicators.

Scenario	Demand: convergence (ζ)	Demand: maximum deviation	MC: maximum deviation	AC: maximum deviation	Number of iterations	α
Baseline	$2 \cdot 10^{-5}$	$8 \cdot 10^{-5}$ (2010)	$4 \cdot 10^{-5}$	$2 \cdot 10^{-5}$	18	0.3
TAX	$1 \cdot 10^{-5}$	$5 \cdot 10^{-5}$ (2050)	$1 \cdot 10^{-5}$	$1 \cdot 10^{-4}$	52	0.3&0.1
NoGAS	$3 \cdot 10^{-5}$	$8 \cdot 10^{-5}$ (2010)	$1 \cdot 10^{-6}$	$9 \cdot 10^{-5}$	18	0.3

3.1.2 Linking electricity prices and costs in bottom-up top-down coupling under changing market environments (working paper)

This sub-chapter consists of a working paper by Sophie Maire, Frank Vöhringer and Philippe Thalmann. It has been published as an EPFL-LEURE Working Paper and submitted to the peer-reviewed journal Energy Policy.

We find it more informative to include the working paper into this report as it is. It fits well at this point, although a few small instances of repetitiveness result.

Abstract

Electricity market liberalization is altering the pricing mechanisms for wholesale electricity and thus the links between generation costs and user prices. This will affect the effectiveness of climate and energy policies. In this paper, we simulate a tightening of these policies under the alternative regulatory assumptions of (1) continued cost-plus price regulation and (2) gradual market liberalization. For these simulations, we developed a modeling framework composed of a technology-rich model of electricity generation and an applied computable general equilibrium (CGE) model. The first is used to minimize generation costs, the second to compute equilibrium prices and quantities. The two models are soft-linked by relating these costs and prices, whereby the relationship between costs and prices depends precisely on the regulatory assumption. Using this framework, we find, for Switzerland, that a tax on electricity is more effective in reducing electricity demand in a liberalized market than under cost-plus regulation.

WP 1 Introduction

Price formation depends on market structure and regulation. Traditionally, wholesale electricity prices were regulated to allow producers to cover their generation costs and achieve an acceptable profit. Such price regulation provides incentives for new capacity additions as firms are guaranteed an acceptable return on investment. Moreover, investment into new capacity may additionally be fostered with the help of different types of subsidies, whether open or covert. In a fully liberalized competitive market, wholesale electricity is priced at marginal cost. This provides no incentive for investment unless there is scarcity, in which case the wholesale price includes a scarcity rent²³, which, in equilibrium, provides incentive for investment into new capacities (IEA 2001).

The current European wholesale electricity market can be described as a largely liberalized market with overcapacity. Wholesale electricity is increasingly priced at short-term marginal cost. However, this price is currently too low to provide incentive for investment into new capacity²⁴. In a liberalized market, such incentive will emerge only as expected prices reflect new capacity needs through scarcity rents at the margin. Today, it is yet unclear whether markets will be fully liberalized or whether elements of central planning will reappear out of the fear of undesired consequences of scarce capacity such as outages and price spikes.

The impacts of changing regulatory environments on price formation are potentially relevant for the effectiveness of energy and climate policies. They must, therefore, be modeled carefully. An adequate way of modeling electricity markets is to couple bottom-up and top-down models to take advantage of the qualities of both model types: The bottom-up model provides a detailed set of electricity generation technologies and minimizes generation costs, while the top-down model simulates the interactions between economic agents and computes equilibrium prices and quantities. For their coupling, many approaches have been developed since Hoffman and Jorgenson 1977, each with its strengths and weaknesses (for a review of the methods, see e.g. Böhringer and Rutherford 2009). Few studies explicitly link costs from bottom-up models to prices in CGE models. Amongst the studies that do, different assumptions are made:

- Fortes et al. 2014 link total energy costs (average cost) variation from TIMES-Portugal to energy prices in GEM-E3 Portugal.
- Martinsen 2011 couples MARKAL Norway and the MSG6 CGE model, linking electricity marginal cost (weighted annual average) to wholesale electricity price.
- Riekkola et al. 2013 link the shadow price (marginal cost) of electricity from TIMES-Sweden to the electricity price in their CGE model. They note that the price issue is not fully resolved.

In fact, the link between costs and prices depends on the regulation. This paper investigates whether assuming different market evolutions, and therefore different price formation mechanisms, has an

²³ For simplification purposes and in line with the scope of our models, we do not consider here transmission constraints, load ranges nor network externalities. Nonetheless, the general argument remains valid.

²⁴ For example, a study from the Swiss Federal Office of Energy (BFE 2013) deems 24 out of 25 potential future hydro projects not viable due to low wholesale electricity prices. The average discounted cost of new hydro plants is estimated at 141 CHF/MWh, which is considerably higher than the production costs of older plants or current average wholesale prices.

important implication on the results when modeling electricity markets and their interaction with the rest of the economy under climate and energy policies.

We build a coupled framework designed to analyze electricity markets and trade in Switzerland. This framework consists of two component models: a TIMES electricity supply model of Switzerland - CROSSTEM-CH - and a dynamic computable general equilibrium (CGE) model - GENESWIS - of the Swiss economy. These two models are coupled through a soft link methodology such that each model keeps its full structure and coherence and the particular strengths of each model are used to inform the other model.

The translation of variables between two fundamentally different models represents a challenge: The main difficulty comes from the fact that the TIMES electricity supply model yields costs of electricity generation, whereas the CGE model uses wholesale electricity prices. Moreover, prices are the main drivers of the CGE model and have a direct impact on the electricity demand that is reinserted as input to the TIMES model.

We analyze a climate policy scenario for Switzerland under two different market assumptions requiring two different coupling approaches: (1) a fully regulated market, where wholesale electricity is priced such that it equals the average cost of electricity production plus a markup, and (2) a progressive evolution to a fully liberalized market, in which the marginal cost of electricity production including scarcity rents defines the price of wholesale electricity.

We show that the way in which costs are linked to prices, and therefore the market evolution expectations, have a sizable impact on the results. Notably, we observe a variation of the reduction in electricity demand induced by the same climate and energy policies.

The outline of the paper is as follows: Section 2 describes the two models and the coupling approaches. Section 3 defines the scenarios. Section 4 identifies the mechanisms at work to understand the results presented in section 5. Section 6 concludes.

WP 2 *Framework*

We build a coupled bottom-up top-down framework that consists of two models: the technology-rich bottom-up model Cross Border TIMES Electricity Model (CROSSTEM-CH), and the dynamic multi-sectoral Computable General Equilibrium (CGE) model (GENESWIS) of the Swiss economy. These two models are coupled through an iterative soft link, where

- the electricity generation production function in the CGE model is determined by the cost structure optimized by the bottom-up model;
- the sectoral electricity demand variations that occur in the CGE as a result of changes in prices, as well as factor and intermediate input price variations are sent back to the bottom-up model.

Before describing the coupling method, we shortly introduce the two models.

WP 2.1 *Models*

WP 2.1.1 Bottom-up model: CROSSTEM-CH

The Cross Border TIMES Electricity Model (CROSSTEM)²⁵ is a technology rich bottom-up optimization model of the electricity system in Switzerland and its four neighboring countries developed on the basis of the TIMES framework. TIMES is a perfect foresight model that, given a comprehensive set of technologies, allows users to minimize the cost of the technology mix over the time horizon, matching a given demand and taking into account a set of constraints (Loulou et al. 2005). It displays a high level of technological detail including operational and maintenance costs, investment costs, fuel costs, lifetime, construction time, renewable potential and decommissioning. CROSSTEM was developed from the existing STEM-E model described in Kannan and Turton 2011. CROSSTEM's time slices are disaggregated to take into account the variability of electricity demand across the day (hourly), different types of day (weekday, Saturday, Sunday) and seasons. For the analysis in this paper, we use the Swiss module of the CROSSTEM model (CROSSTEM-CH), where trade with the neighboring countries is exogenous.

WP 2.1.2 Top-down model: GENESwIS

GENESwIS is a dynamic computable general equilibrium (CGE) model of the Swiss economy designed to analyze energy and environmental policies (Vöhringer 2012).

In GENESwIS, agents act rationally and are forward-looking over the time horizon 2010-2050. Households maximize utility under given preferences and a budget constraint. Firms maximize profit under given production technologies and perfect competition. The Government collects taxes to provide public goods. Domestic and foreign goods are assumed to be imperfect substitutes (Armington 1969). Non-satiation in consumption implies that demand must equal supply in all markets under flexible positive prices.

The energy sector is disaggregated to allow for energy and environmental policy analysis. Non-energy industries are separated into aggregates taking into account their possible importance in the formation of capital for the electricity sector and their affiliation to different CO₂ taxation schemes (ETS, CO₂ tax). The electricity sector has been split into 'Electricity Generation' and 'Electricity Transport and Distribution' to permit the differentiation between wholesale electricity and retail electricity prices.

Capital is modeled as putty-clay. Thus, capital invested into one sector (industry, services or electricity) cannot be transformed into capital for another sector.

WP 2.2 *Coupling*

The "soft link" coupling method (Wene 1996), involves keeping the models' full structure and complexity, exchanging a chosen set of variables and solving the models iteratively until convergence is reached on a given criterion. It has the advantage of allowing the use of detailed and complex models, which we deem important for an analysis of the impact of climate and energy policies on the electricity sector and the entire economy. It permits for the representation of the electricity sector's

²⁵ Developed by the Energy Economics Group at the Laboratory for Energy Systems Analysis (LEA), Paul Scherrer Institute (PSI), Switzerland.

interaction with the other sectors of the economy (Schäfer and Jacoby 2005), and allows for different types of policies to be adequately modeled: market instruments in the CGE model and technology standards in the bottom-up model.

Coupling through a soft link prioritizes the strengths of each model: The electricity generation mix and costs from the bottom-up model are given priority over the electricity production function of the CGE model. The latter effectively becomes a Leontief function which is parametrized with information from the latest bottom-up run. On the other hand, the endogenous electricity demand reaction of the top-down model is given precedence over the initial demand assumption for the electricity supply model. Additionally, the variations of factor and intermediate input price variations due to general equilibrium effects modify the investment costs, and operation and maintenance costs of the bottom-up model.

Figure 49 depicts the exchange of information between the two models. Electricity generation costs and their components as well as export revenues and import costs are extracted from the CROSSTEM-CH model and translated for the CGE model into a) the wholesale electricity price and b) input shares for factors and commodities to the electricity generation cost function. The sectoral²⁶ electricity demand quantities simulated by the GENESwIS model are then sent back to become inputs to the CROSSTEM-CH model. To account for changes in the economy, factor and intermediate input prices from GENESwIS are used to modify the investment costs and operation and maintenance costs of the different technologies in the bottom-up model. This sequence is iterated upon until the vector of quantities of total electricity demanded each year converges.

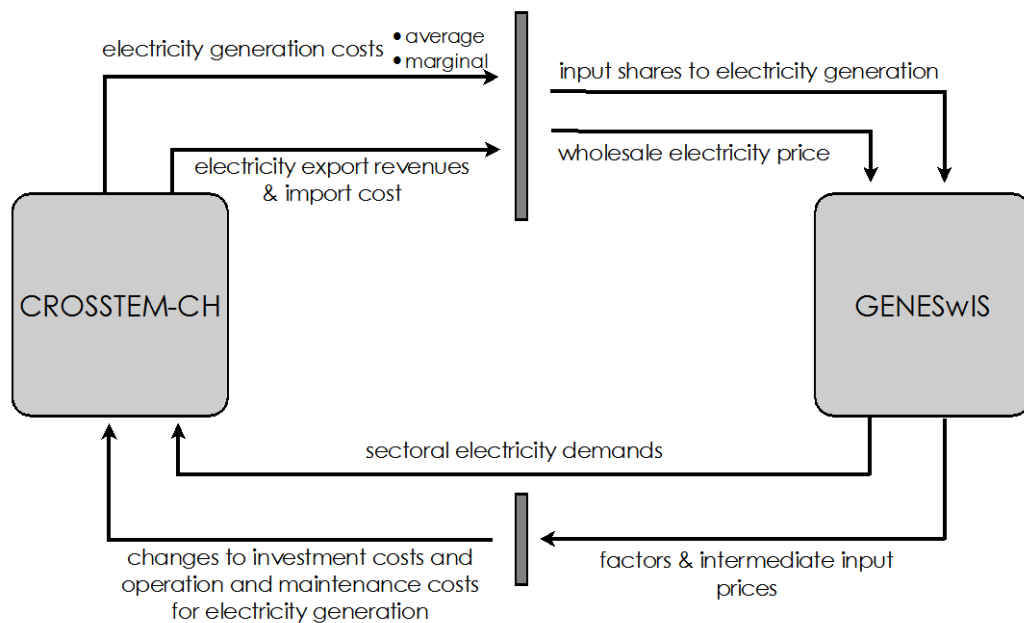

Figure 49: Information exchange between the two component models

²⁶ GENESwIS simulates yearly electricity demands that are distributed to each of the 288 time slices of the CROSSTEM-CH with the help of sectoral load curves.

The modeling framework has been set up such that the link between CROSSTEM-CH's generation costs and GENESWIS' wholesale prices for electricity can be modeled in different ways:

- Average cost plus pricing: The wholesale price is set at CROSSTEM-CH's average cost level plus a markup.
- Marginal cost pricing: CROSSTEM-CH's marginal cost is the shadow price of the commodity balance and represents the increase in total system cost due to an additional unit of demand (Loulou et al. 2005). It reflects all constraints and costs (incl. investment cost) and can therefore be seen as a long-term marginal cost, or marginal cost including scarcity rents for capacity. As the CGE model does not disaggregate the year into 288 time slices, the marginal cost is aggregated to an annual demand-weighted marginal cost.

To help with the convergence of the models, which is hampered by the stepwise behavior of the bottom-up supply curve, we introduce a supply elasticity in the Electricity Transport and Distribution sector of the CGE model. For this purpose, we insert a fixed resource at the top of the Electricity Transport and Distribution's nest. The elasticity of substitution between the fixed resource and the rest of the inputs is calculated²⁷ such that, given the share of the fixed resource, the supply elasticity of the sector equals a selected value²⁸ (see Rutherford 1998). This method was inspired by the work of Lanz and Rausch 2011 who introduce a demand elasticity to parameterize the bottom-up demand. They show that the choice of demand elasticity does not affect the results but that a good approximation of the top-down demand response reduces the number of iterations needed for convergence.

Despite the introduction of a supply elasticity in the Electricity Transport and Distribution sector of the CGE model, it is frequent for the models to lock up into an oscillation between two marginal costs. The electricity demand oscillates between two values and does not converge. To avoid this problem, we introduce a dampening of the demand response in the coupler: Instead of the last electricity demand vector, we send a Gauss-Seidel combination of the CGE electricity demands of the previous iterations (equation 3.1.9) to the bottom-up model:

$$D_{i+1} = \alpha D_i + (1 - \alpha) D_{i-1} \quad (3.1.9)$$

where $\alpha \in [0, 1]$ represents the length of the step towards the demand of the last iteration.

WP 3 Scenarios

We simulate a baseline and a policy scenario for two different types of electricity markets in Switzerland: a regulated market, and progressive liberalization to a fully liberalized market (see Table 22).

²⁷ $\sigma = \eta \frac{\theta_R}{1 - \theta_R}$, with σ the elasticity of substitution between the fixed resource and the rest of the inputs, η the supply elasticity and θ_R the share of the fixed resource.

²⁸ The value of supply elasticity can be set such that it helps with convergence (approximating the bottom-up supply elasticity), as it has no impact on the results.

Table 22: Scenarios matrix

		Policy scenarios	
		Baseline (BAU)	Tax (TAX)
Market regulation scenarios	Regulated market	BAU_REG	TAX_REG
	Liberalized market	BAU_LIB	TAX_LIB

The baseline (*BAU*) scenarios are based on the *weiter wie bisher* (i.e. "more of the same") scenario of the Energy Perspectives 2050 (Prognos 2012). They include current policies such as an Emissions Trading Scheme, a CO₂ tax on gas and heating fuels for the non-ETS sectors and households, and a subsidy program for the energy refurbishment of buildings. For each pricing scenario, the GENESWIS model is calibrated such that the electricity demands and CO₂ emissions follow the paths projected by Prognos 2012.

The *TAX* scenarios represent more stringent climate and energy policies. A tax is levied on electricity at a rate of 10% in 2020, increasing linearly to 50% in 2050. The Emissions Trading Scheme stays identical as in the *BAU* scenario, but the CO₂ tax on gas and heating fuels is increased linearly from current level (60 CHF/t) to 200 CHF/t in 2050. A CO₂ tax on transport fuels is introduced at 50 CHF/t in 2035, reaching 200 CHF/t in 2050.

Under regulation (scenario *REG*), firms are usually allowed to cover their costs and make an appropriate profit. We assume accordingly that electricity is priced at average cost plus a small markup.

We assume in the liberalized market scenario (*LIB*) that the electricity market will be entirely liberalized from 2025 onwards and that the price will then follow the long-term marginal cost of the bottom-up model. From 2010 to 2025, the market is in transition and prices reflect an increasing importance of marginal cost pricing. Profit is calculated such that the price of wholesale electricity is pushed from the average cost given by the CROSSTEM-CH model (*AC*) to the assumed market price (*P_m*).

$$\text{Profit}(t) = \frac{P_m(t) - AC(t)}{P_m(t)} \quad (3.1.10)$$

We analyze the policy scenarios for the two market regulation assumptions *TAX_LIB* and *TAX_REG* as deviations from the respective baseline scenarios *BAU_LIB* and *BAU_REG*. It is uncommon in a CGE setting to have two different baselines. Actually, the central targeted baseline parameters, namely electricity demands and CO₂ emissions per fuels, are the same in both of our baselines. However, it was necessary to recalibrate the model framework under the different coupling mechanisms to match the targeted baseline parameters, as electricity prices are defined in a different manner.

WP 4 Mechanisms at work

WP 4.1 Prices in the baseline scenarios

As mentioned above, the wholesale electricity market prices simulated in the baselines for the two different market regulation scenarios diverge. As can be seen in Figure 50, annual average and marginal costs for the targeted baseline demands are distinct not only in level, but also in evolution. According to whether we assume a regulated market (*REG*) or a liberalized market (*LIB*), the whole-

sale electricity prices are linked to respectively the average cost or marginal cost of the bottom-up model. This largely specifies the level and evolution of the prices in each market scenario (Figure 50).

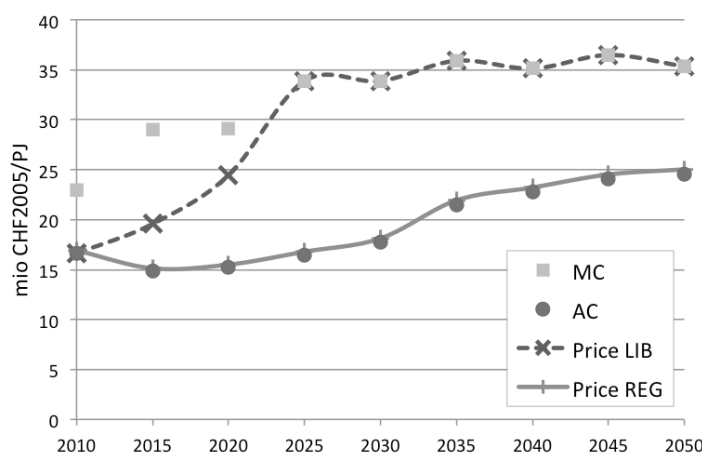

Figure 50: Wholesale electricity pricing under the two baselines (LIB for the liberalized market and REG for the regulated market) in comparison with annual average (AC) and marginal (MC) costs from the CROSSTEM-CH model.

WP 4.2 *The effects of an electricity tax*

A tax on electricity consumption increases end-user prices for electricity. In equilibrium, however, this end-user prices increase does not amount exactly to the level of the tax. The reasons are twofold:

- Electricity demand is flexible: A rise in end-user price induces a reduction in demand. The new equilibrium price will hence be lower than the initial price plus the tax.
 - This new (and reduced) electricity demand is then passed on to the CROSSTEM-CH model (see Figure 49), which lowers electricity generation and hence alters generation costs. As generation costs are linked to the wholesale electricity price, their alteration will, in turn, have an effect on end-user prices.
- To analyze the city demand reaction and end-user prices, we thus also need to analyze the influence of changes in demand on generation costs.

WP 4.3 *The effect of demand changes on marginal and average generation costs*

Both average and marginal costs generated by the CROSSTEM-CH model include all relevant costs, i.e. fuel costs, operation and maintenance costs, investment costs, taxes, and the electricity trade deficit (which is usually negative for Switzerland, i.e. a trade surplus). They both depend on the composition of the technology mix, albeit in different ways: The marginal cost is linked to marginal technologies, whereas the average cost depends largely on the degree of utilization of technologies with high variable costs, such as gas-fired power plants.

Thereby, technology restrictions, or an increase in demand large enough to require the introduction of a more expensive technology, will increase the marginal cost. Likewise, a reduction in demand important enough to make the most expensive technology obsolete, will decrease the marginal cost.

For the average cost, things are more complicated, because the direction of change depends not only on the marginal technology, but on the technology and cost structure as a whole. For example, if the technology mix is composed mostly of technologies with high fixed costs, a decrease in demand increases average cost. In contrast, if the technology mix includes a large share of technologies with high variable costs, a decrease in demand also decreases average cost.

WP 4 Results

In this section, we analyze the effectiveness of the *TAX* scenario policies under two different market assumptions: gradual liberalization (*LIB*) and regulation (*REG*). To do this, we first investigate the effect of the policies on the generation costs in the Swiss context.

WP 5.1 Generation costs

WP 5.1.1 Marginal cost

As can be seen in Figure 51a, the marginal cost does not vary greatly for the *TAX* scenarios relative to the baselines for either of the market regulation scenarios. Demand reductions under the *TAX* scenarios are not large enough to shock the technology mix deeply and there are no technology restrictions in addition to the baselines. Therefore, the marginal technologies, and hence the marginal cost, do not change much in yearly average (although they may change in some particular time-slices).

WP 5.1.2 Average cost

In contrast, average cost is reduced in the *TAX* scenarios relative to the baselines (Figure 51a). Due to a technology mix comprising many depreciated plants and to the optimized cost structure of the CROSSTEM-CH model, variable costs represent a major share of total cost. Furthermore, at each iteration, the investment decisions as well as running-schedules are re-optimized over the entire time horizon of the model, which further increases the total proportion of variable costs in the framework. A dominant share of variable costs implies that average cost is lower when less electricity is produced.

The variation of average cost for the liberalized market (*TAX_LIB*) is greater than under regulation (*TAX_REG*). This is due to the fact that total electricity demand is reduced further in the liberalized market scenario than in the regulated market scenario.

WP 5.2 From costs to end user prices under alternative market regulation

We will now investigate what the different responses of the marginal and average costs imply for the wholesale, retail and end-user prices, and for electricity demand under alternative market regulations.

WP 5.2.1 Liberalized market

In the liberalized market scenarios, wholesale electricity prices are increasingly linked to the marginal cost. We observe that the marginal cost is not greatly affected by the demand reduction induced by the *TAX_LIB* scenario (Figure 51a). As a result, wholesale electricity prices (Figure 51b) are impacted only slightly. Retail electricity corresponds to electricity transported and distributed to the users. An important share of its production cost is due to the purchase of wholesale electricity. The prices of commodities and services constituting the remaining share are not affected greatly by the policies of

the *TAX_LIB* scenario. Hence, retail electricity prices vary in the same direction as wholesale electricity prices, although this variation is dampened (Figure 51b). End user prices are defined as retail prices gross of tax. The electricity tax included in the *TAX* scenario increases the end user price of electricity (Figure 51c), which reduces electricity demand (Figure 51d).

WP 5.2.2 *Regulated market*

For the regulated market scenarios, wholesale electricity prices are closely linked to average cost. They are therefore reduced as a result of the electricity demand reduction induced by the energy policies, namely the electricity tax, included in the *TAX_REG* scenario (Figure 51a&b). Consequently, retail electricity prices also decrease relative to the baseline (Figure 51b). Hence, the end user price increase (gross of tax) is smaller in the regulated market (*TAX_REG*) than in the liberalized market (*TAX_LIB*), as can be seen in Figure 51c. The resulting reduction in demand is therefore smaller in the regulated market than in the liberalized market²⁹ (Figure 51d).

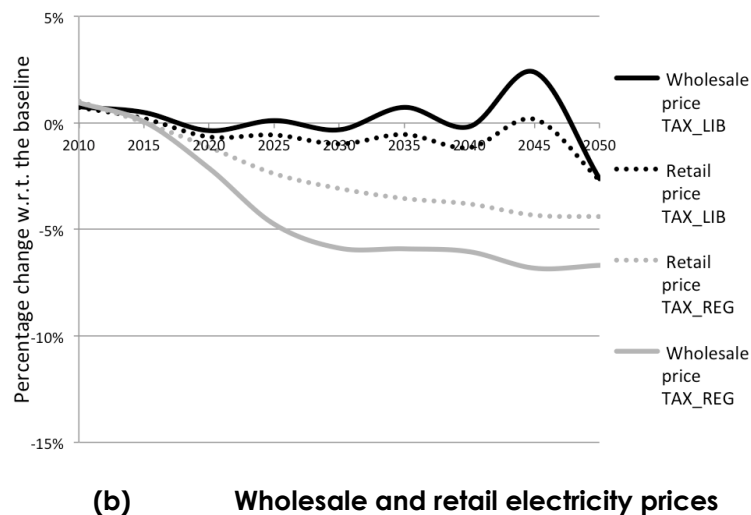
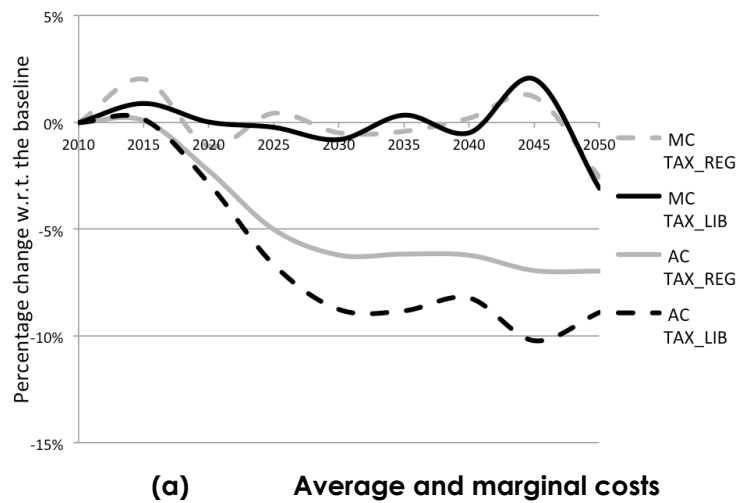

²⁹ These results are qualitatively robust to different calibrations of the CGE model.

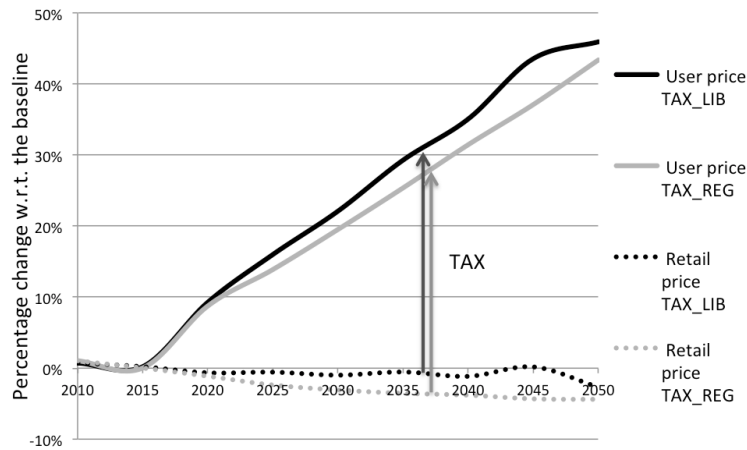

(c) End user prices (gross of tax) for electricity

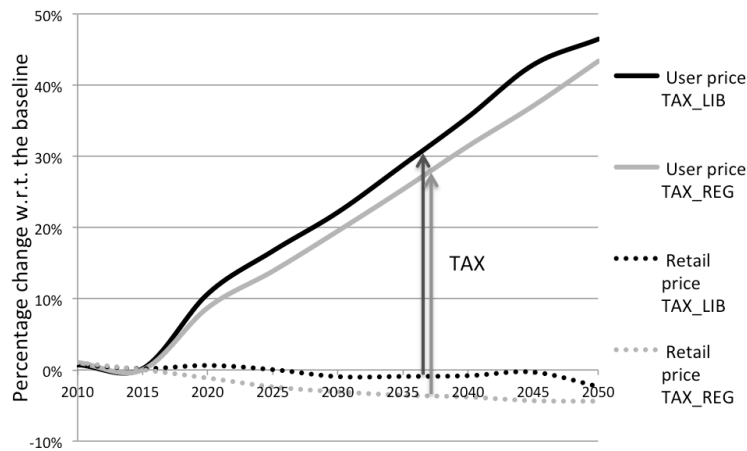

(d) Electricity demands

Figure 51: Percentage change of - (a) average cost (AC) and marginal cost (MC), (b) wholesale and retail electricity prices, (c) electricity prices paid by the end users (gross of tax) and retail electricity prices (net of tax), and (d) electricity demands - for the scenarios TAX_LIB and TAX_REG compared to the baselines BAU_LIB and BAU_REG, respectively.

WP 6 Conclusions

In this paper, we show that assumptions on the future evolution of electricity market regulation have an impact on the effectiveness of electricity taxes to curb demand. In a coupled bottom-up top-down modeling framework, the way we translate costs into prices needs to reflect the nature of market regulation: Assuming a more or less liberalized market implies linking the wholesale electricity price to either the average cost or the marginal cost of electricity generation.

The regulated market, which links wholesale electricity market prices to average costs, is easier to model, because it avoids the numerical convergence issues stemming from the stepwise behavior of marginal costs. However, if the market is not tightly regulated, this linking assumption is inappropriate and leads to its misrepresentation. As a consequence, the estimation of the effectiveness of energy or climate policies is erroneous. As we have shown, the electricity demand reduction fostered by market-based policies is stronger in a liberalized setting than in a regulated market.

Before generalizing this result, some caveats are in order. First of all, the marginal cost assumed in our modeling framework is a demand-weighted annual average of the marginal costs for all time slices, which is a strong simplification. In addition, we assume that electricity generation is optimized over the full modeling horizon with perfect foresight. Finally, we make specific, albeit representative for Switzerland, assumptions about policy changes and available technologies. Further research is needed to explore the consequences of modified pricing mechanisms in (partially) liberalized markets under different national circumstances, policies and technological options.

Notwithstanding, it is important to take ongoing and projected market liberalization into account and to disclose pricing assumptions when interpreting coupled models' results.

3.1.3 Further results of the coupled framework

In the previous section, which is a self-contained scientific paper, we only presented a small selection of ELECTRA-CH's simulation results to stay with the regulatory focus of the paper. In this section, we present results of the domestic scenarios simulated with the ELECTRA-CH framework in a more comprehensive manner.

3.1.3.1 Reminder for the domestic scenarios

A detailed description of the scenarios can be found in section 1.4.1. Domestic scenarios were developed to test and illustrate the ELECTRA-CH framework. The results presented in this section are closely linked to the nature and timing of the policy instruments. We found it judicious to recapitulate the important features of the scenarios. For this purpose, Figure 52 gives a comparison of the varying instruments of the domestic scenarios.

	Baseline	TAX	NoGAS
Market instruments (GENESWIS)	ETS	Same as baseline	Same as baseline
	CO ₂ tax on heating fuels 36CHF/t(2010) 72CHF/t(2020-50)	CO ₂ tax on heating fuels 72CHF/t (2020) 200CHF/t (2050)	Same as TAX
		CO ₂ tax on transport fuels 50CHF/t (2035) 200CHF/t (2050)	Same as TAX
		Electricity tax 10%(2020) 50%(2050)	Same as TAX
Regulation (CROSSSTEM)	No net import (yearly average)	Same as baseline	Net import (same total energy [PJ] as imported gas)
			No gas power plants

Figure 52: ELECTRA domestic scenarios: comparison of the varying instruments.

3.1.3.2 Electricity prices and demand

In the TAX scenario, the wholesale electricity price does not vary much compared to the baseline scenario (Figure 53a). This is due to the only minor variations in marginal cost, as the electricity

generation mix is not altered fundamentally (see 3.1.3.5). However, due to the policies of the TAX scenarios, namely the electricity tax, the user price of electricity increases in the TAX scenario (Figure 53b). This user price increase induces a reduction of the electricity demand (Figure 54) with regard to the baseline.

In the *NoGAS* scenario, the marginal cost of electricity production increases (see 3.1.3.5), which pushes the wholesale electricity price up (Figure 53a). This translates into a greater increase in electricity user prices (Figure 53b) and a greater decrease of electricity demand (Figure 54) compared to the *TAX* scenario.

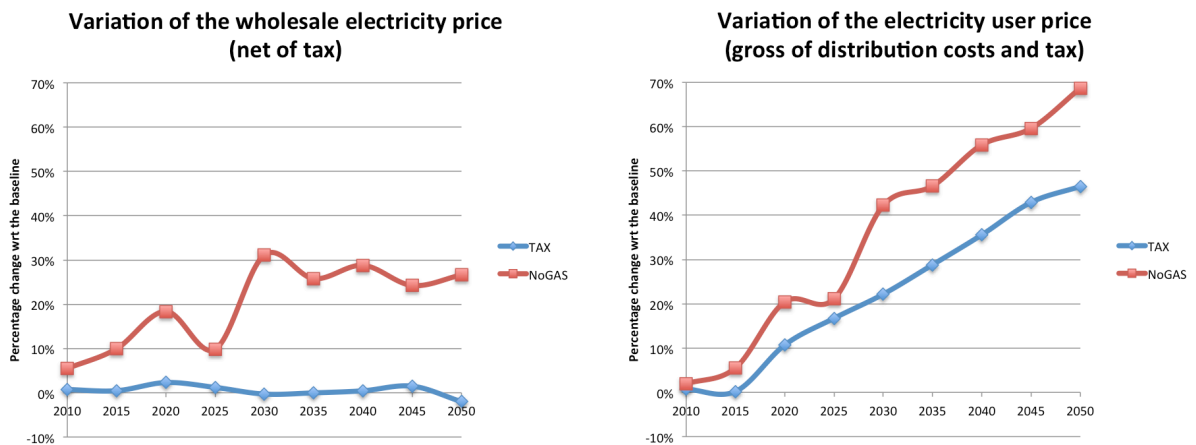

Figure 53: Variation of (a) wholesale electricity price (net of tax) and (b) electricity price for users (gross of distribution costs and tax) for the TAX and NoGAS scenarios with regard to the baseline.

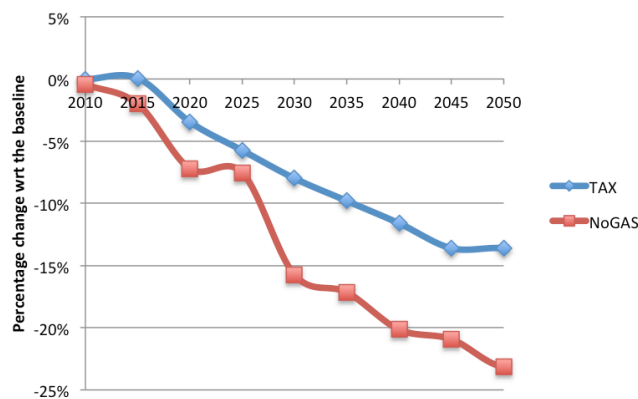

Figure 54: Variation of total electricity demand for the TAX and NoGAS scenarios with regard to the baseline.

3.1.3.3 Electricity generation mix

The Swiss electricity generation mix and installed capacity from the coupled framework scenarios are given in Figure 55 and Figure 56. As mentioned before, the *Baseline scenario* follows the *weiter wie bisher* demand from the Energy Perspectives 2050 (Prognos 2012). In this scenario, the existing

nuclear capacity is gradually replaced by natural gas based generation in the short to medium term, and a combination of gas and renewables in the long term. By 2020, already 365 MW of nuclear capacity is retired (KKW Mühleberg retires in 2019), while the demand increases by 5%. To solve this problem, the model invests in around 1.3 GW of base-load type natural gas generation (see Figure 56). By 2035, the remaining nuclear capacity³⁰ is replaced by a combination of base-load (2.9 GW) and flexible (2.5 GW) gas power plants. The flexible gas generation capacity enables better supply-demand balancing in conjunction with the import/export cycles. The latter generates additional trade revenue due to diurnal and seasonal arbitrage electricity trade, which is further discussed in section 3.1.3.4. By 2050, the increasing gas prices combined with technology learning (capital cost reduction) in renewable technologies leads to increasing investments in solar PV (10 GW). By 2050, 52% of the net generation comes from hydro, 32% from gas, and the remaining 16% from renewables.

Compared to the *Baseline* scenario, the *TAX* scenario has a lower demand (14% lower by 2050), as shown in Figure 54, but with no technology or CO₂ emission restrictions, the overall generation mix and installed capacity are very similar to the *Baseline* scenario. While the total capacity of hydro and nuclear technologies remains unchanged with respect to the *Baseline*, there is a proportionate lowering in gas based generation due to the lower demand. Hence, there is an installed gas capacity of 1 GW by 2020, 4.1 GW by 2035 (vs. 5.4 GW in *Baseline*) and 3.1 GW (vs. 4.7 GW in *Baseline*) by 2050. The solar PV generation remains unchanged from the *Baseline* scenario, i.e. full potential is tapped by 2050. The self-sufficiency constraint prevents the model from increasing domestic production and exporting the excess.

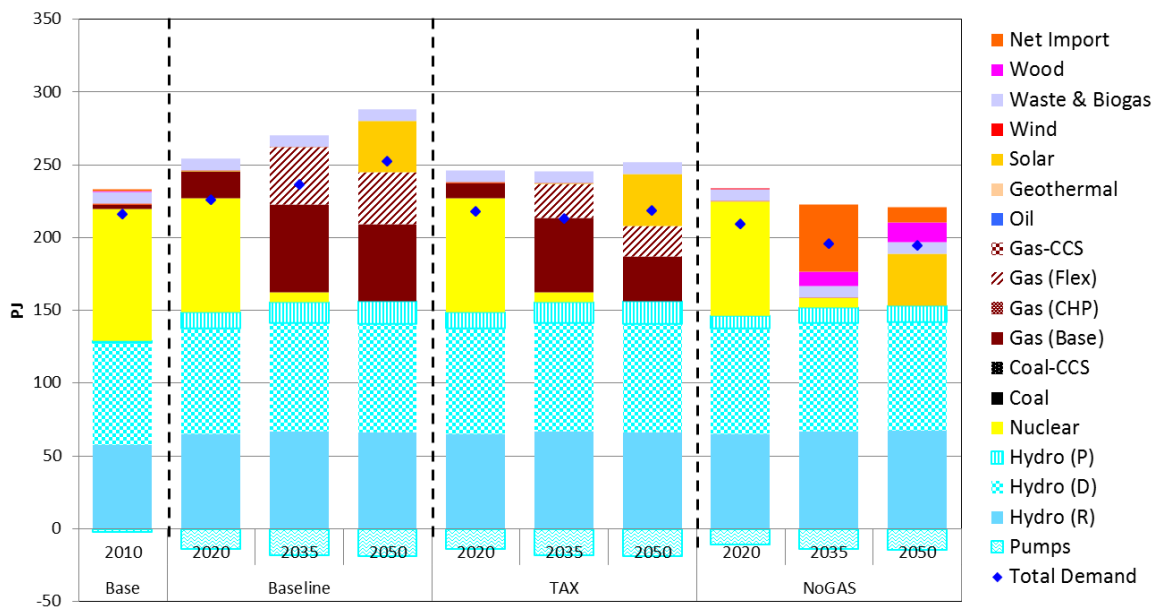

Figure 55: Electricity generation mix (Switzerland)

³⁰ Although the last nuclear power plant in Switzerland (KKW Leibstadt) goes offline in 2034, 2035 still shows that 2.5% of the total electricity generation comes from nuclear. This is because the milestone year displays an average of all the years within that time period.

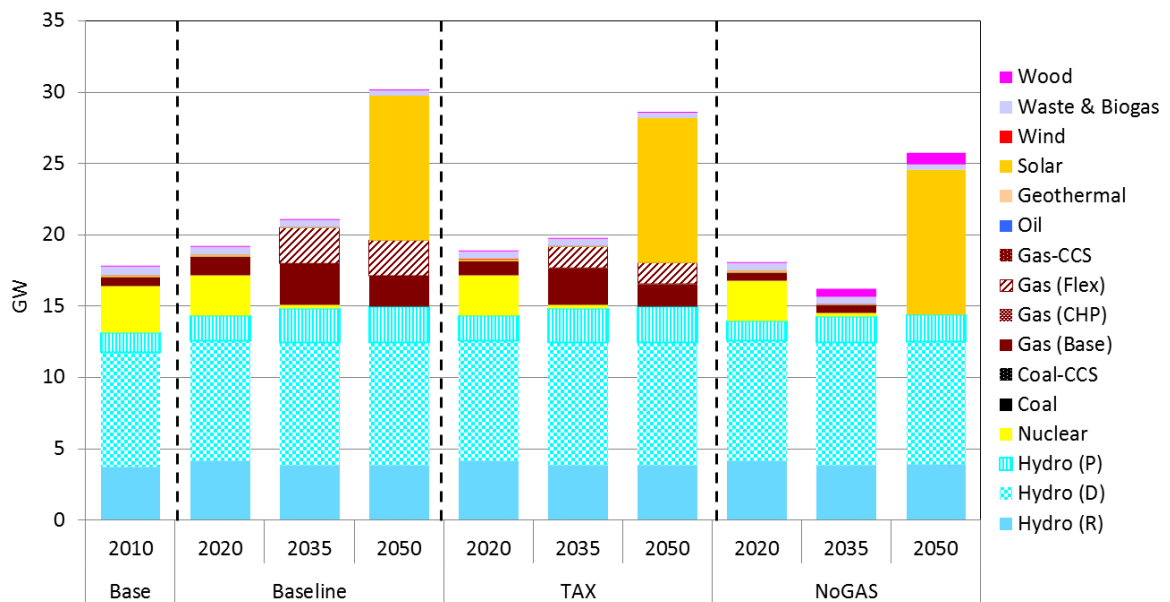

Figure 56: Installed Capacity (Switzerland)

The *NoGAS* scenario provides a very different picture compared to the other two scenarios. This scenario has an even lower demand than the *TAX* scenario (23% lower than *Baseline* and 11% lower than *TAX* by 2050, see Figure 54). No natural gas based generation is allowed in this scenario. Instead, the model is allowed to import electricity to the same level as gas imports for electricity production in the *TAX* scenario (see Figure A 28, Appendix A). In the near term (2020), due to the lowering of the demand, the existing nuclear, hydro and renewable capacities are almost enough to supply the demand (only 0.5 PJ of net imports in 2020). By 2035, when all the nuclear capacity will have been retired, the model finds it cost optimal to import the majority of the retired nuclear generation (around 46 PJ, or 22% of the total demand), with some investment in wood fired power plants to provide seasonal base-load (0.6 GW by 2035). The levelized costs of other new renewable technologies such as solar PV are still not competitive in 2035 versus the import prices from the surrounding regions. As with the other scenarios, by 2050 solar PV becomes competitive due to increasing import prices as well as lowering electricity generation costs from renewables, fully tapping the available potential by 2050 (10 GW). Nonetheless, net imports of around 11 PJ (about 5% of the total demand) are still required to meet the electricity demand. Note that these results are significantly different from the *NoGAS* scenario (Sc.3) in the CROSSTEM model runs (see section 2.1.11.2.1). The reason for this difference is partially explained in section 2.1.12, referring particularly to the differences in import/export price assumptions in CROSSTEM-CH versus the endogenous import/export prices in CROSSTEM. The higher electricity import costs assumed in the CROSSTEM-CH model result in higher investments in renewable technologies while minimizing the net electricity imports, whereas cheaper electricity generation costs in neighbouring regions favors electricity imports for Switzerland in the CROSSTEM model.

3.1.3.4 Generation schedule

One of the main highlights of the CROSSTEM-CH model is its ability to depict hourly load patterns. The hourly electricity supply and demand balance curves of Switzerland for an average weekday for all four seasons for the *TAX* scenario are shown in Figure 57 for the *TAX* scenario. Generation schedules for the other scenarios can be found in Appendix C.

It can be observed that the base-load generation (river hydro and base-load gas plants) only covers around half of the demand (blue line in upper panel of Figure 57), even during the summer when the demand is lowest. Since there is a large installed capacity of solar PV, this covers the peak time (08:00-16:00), with imports required during the early morning hours as well as evening and/or night hours for all the seasons. In spring and summer, solar availability is high (see Figure A 24 in Appendix A), and with the support of flexible dam hydro and flexible gas based production, covers the peak demand adequately. Switzerland also generates excess electricity during these peak hours by scheduling dam hydro plants, with the surplus electricity being exported. During the early morning (00:00-08:00) and late evening (20:00-00:00) hours, when electricity import prices are assumed to be cheaper, Switzerland imports the electricity to cover its demand as well as store the excess using pumped hydro (light blue area in the export plots in Figure 57).

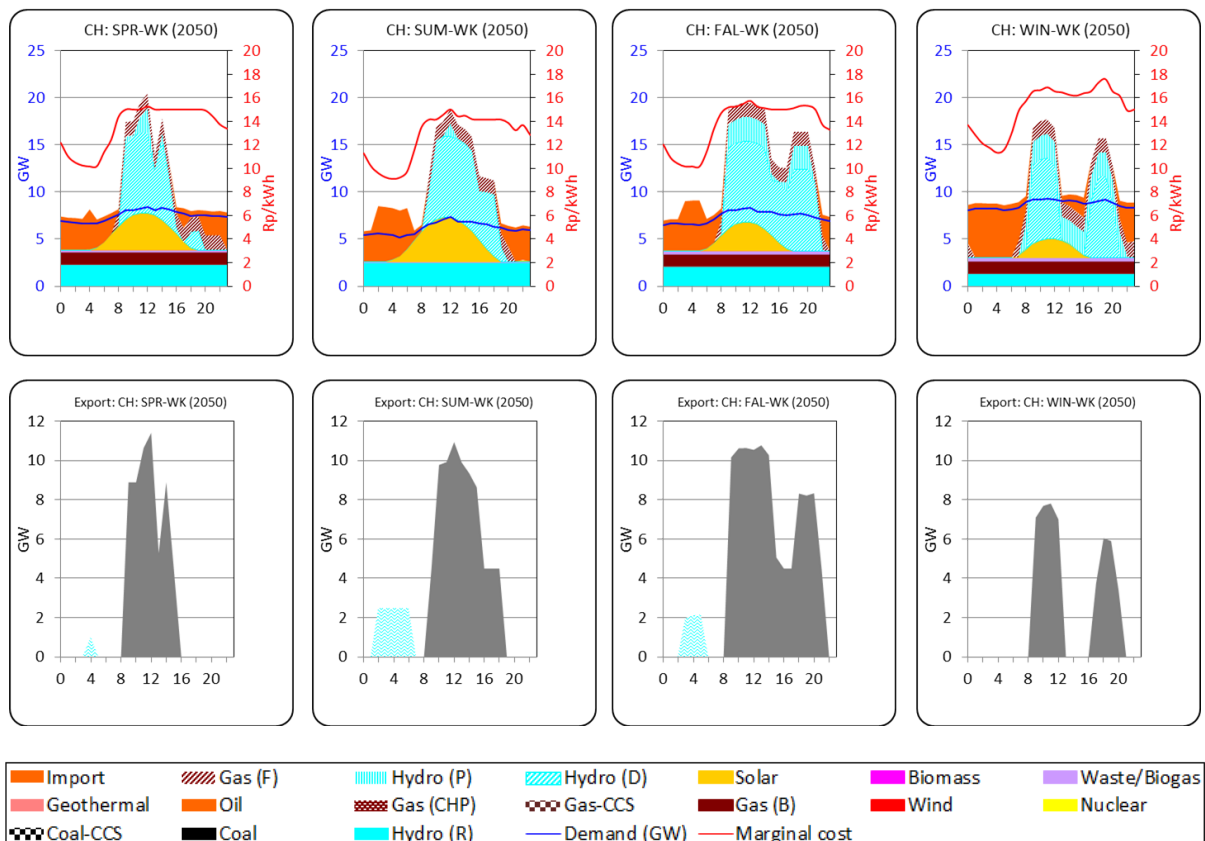

Figure 57: Electricity generation schedule on weekdays (2050) – TAX

In autumn (fall), most of these patterns are repeated, with the addition of another export peak during the evening hours. The reason for this second peak is again the import/export price assumptions (see Figure 31), with the model maximizing the amount of exports at these high price hours to generate more revenue. Although there is a reduction in solar PV output compared to summer and spring, it is compensated by flexible dam hydro generation, which is highest during fall (see Table 3).

The generation schedule in winter is very similar to autumn. Since solar PV outputs and dam hydro availability is at its lowest during winter, the demand is met with base-load gas plants and imports. Imports occur almost throughout the day, except for a few hours around noon (09:00-12:00) and in the evening (17:00-19:00) when import/export prices are assumed to be high. The dam hydro generation is scheduled in those hours to meet the demand as well as to export. Dam hydro is used in this

manner to exploit the export prices, which is found to be more economical than using it more evenly throughout the day to minimize the imports.

The hourly generation profile of the *Baseline* scenario is very similar to the *TAX* scenario, with only the magnitude of the demand and accordingly the gas based generation increasing (see Figure 58 and Figure 59). This also explains why the marginal cost (red line in upper panel of Figure 58 and Figure 59) does not vary much across both these scenarios, as both scenarios have the same marginal technology (also see section 3.1.3.2, Figure 53).

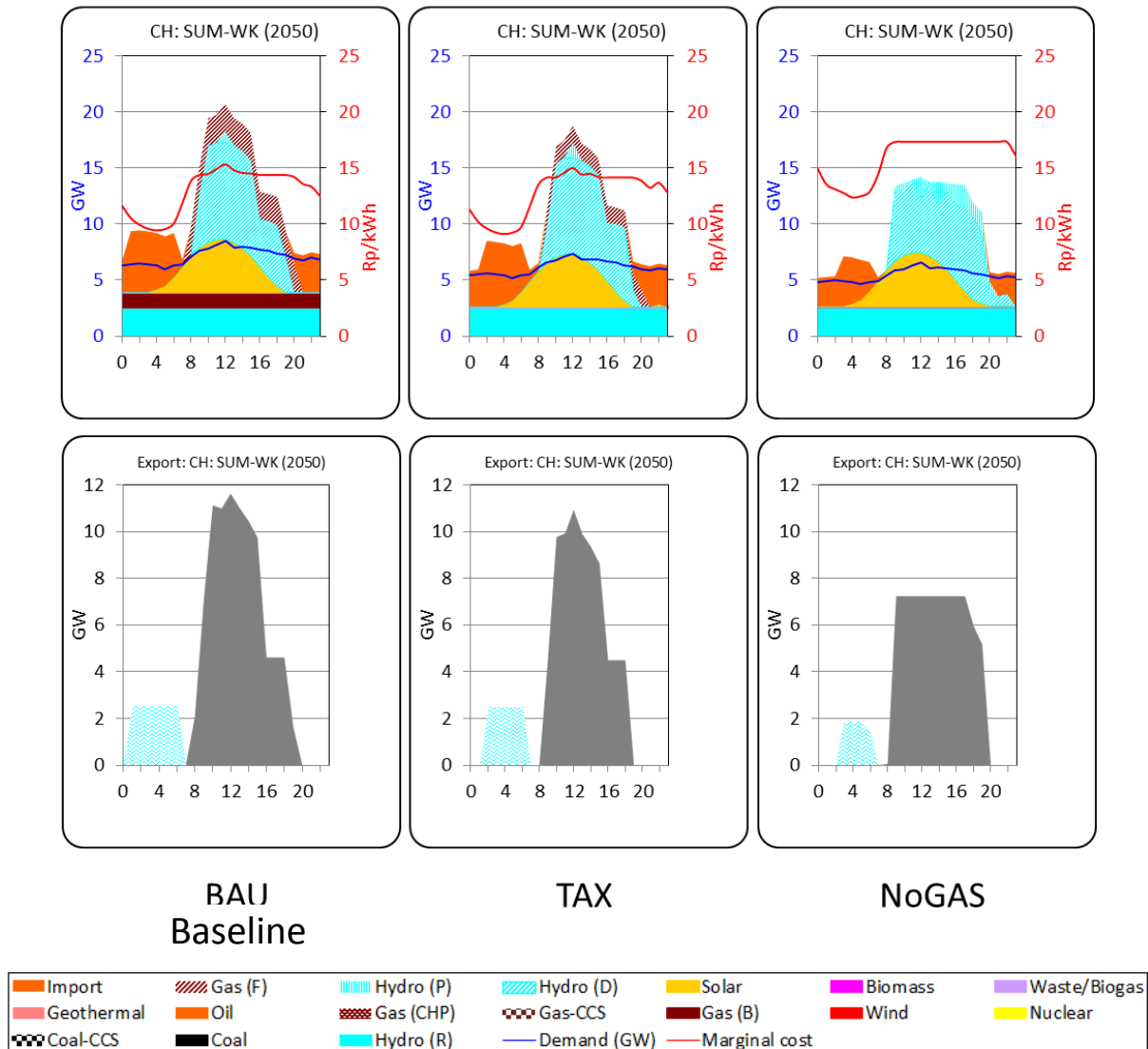

Figure 58: Electricity generation schedule on a summer weekday (2050)

For the *NoGAS* scenario, the generation schedules still have a lot of similarities with the other two scenarios, with the obvious exemption of gas based generations. In summer (Figure 58) and spring (Appendix C), the model optimizes the use of flexible hydro and imports to complement the steady outputs from solar PV and base-load river hydro. Import and export patterns are also similar, but due to the lower generation capacities, there is correspondingly a reduction in the export volumes as well.

In fall (Appendix C) and winter (Figure 59), base-load generation from river hydro is supplemented by wood/biomass and geothermal sources. As with the previous scenarios, electricity is imported throughout the day except for the two high price peaks (noon and evening), and the flexible hydro plants are scheduled at these hours to maximize exports at higher prices and generate more trade revenue. The increasing dependence on expensive electricity imports, reduced electricity trade revenue, and reliance on more expensive renewable technologies such as geothermal is also reflected in the marginal price, which is highest for the *NoGAS* scenario amongst the three scenarios. It is this increase in marginal price that lowers the demand even further compared to the *TAX* scenario (see section 3.1.3.2).

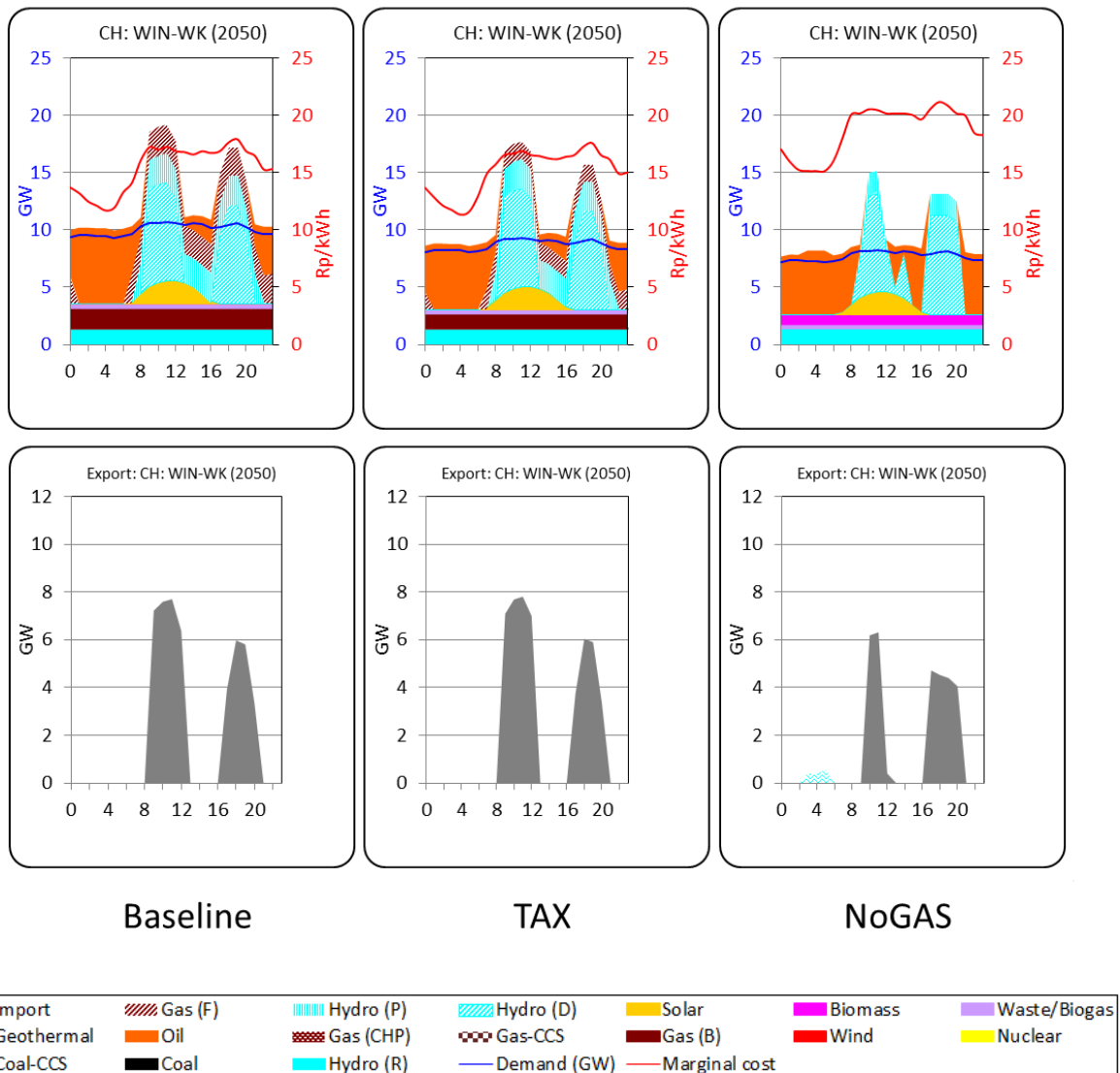

Figure 59: Electricity generation schedule on a winter weekday (2050)

3.1.3.5 System cost and average electricity cost

Figure 60 shows the annual undiscounted electricity system costs, for all the scenarios. The costs are broken down to various cost components such as capital costs (annuities on investments), taxes (levy on nuclear spent fuel and CO₂), fixed and variable operation and maintenance costs, fuel costs and trade balances (which refer to net profits if negative or cost if positive) from electricity import or export. The net system cost for each scenario is also shown in the figure (blue marker).

One can see the increasing electricity system cost as we move from 2010 to 2050 in all three scenarios. For the *Baseline* scenario, in the near to medium term (2020, 2035) the main increase is in capital and fuel cost due to the investment and operation of gas power plants. The higher share of gas based generation as well as a rise in natural gas price assumptions increase the fuel costs. The increasing CO₂ emissions result in a gain in the taxes (CO₂ taxes) as well. By 2050, the fuel cost and taxes are stable due to partial replacement of gas plants with solar PV, which in turn drastically increases the capital costs.

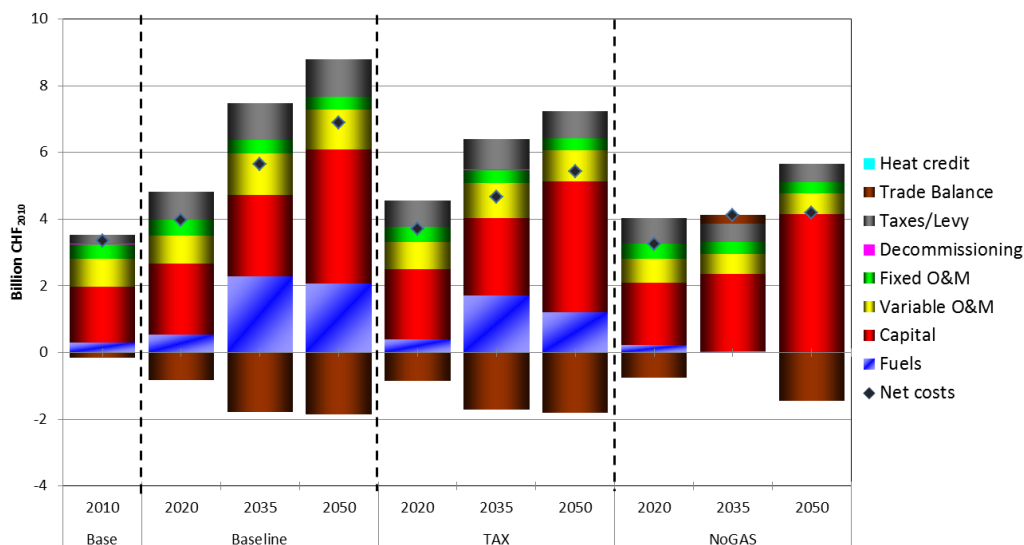

Figure 60: Undiscounted electricity system cost: Switzerland

The *TAX* scenario follows the same system cost pattern as the *Baseline* scenario, but with a slightly lower magnitude of costs due to the lower capacities required to supply the lower demand.

For the *NoGAS* scenario, with overall electricity demand being the lowest, there are no large investments in the near to medium term (2020, 2035), apart from some biomass and waste incinerator power plants (see Figure 56), which reduces the total system cost with respect to the other scenarios. With no gas based production, there is no CO₂ tax to be accounted for, with O&M costs decreasing as well. In 2035, Switzerland has a positive net electricity trade balance due to the high share of electricity imports (22%) to meet the demand. But by optimising the timing of imports and exports, this net import cost only accounts for 8% of the total system cost. By 2050, with higher investments in renewable technologies (solar PV, see Figure 56) increasing the domestic production, dependence on imports is reduced and a trade revenue surplus is obtained once again, which in turn offsets the increasing capital cost of renewable technologies and keeps the net costs even lower than the other two scenarios. It is worth remembering that the electricity tax is applied in the CGE model. Therefore there is no significant change in the tax component of the electricity system cost.

The differences in the total system costs across the three scenarios are also reflected in the average electricity cost. The average cost of electricity declines by 9% in 2050 for the *TAX* scenario compared to the *Baseline* scenario (see Figure 61). The total electricity system cost and thereby the average cost of electricity in the *NoGAS* scenario decreases even further (30% decrease in average cost by 2050 compared to *Baseline*).

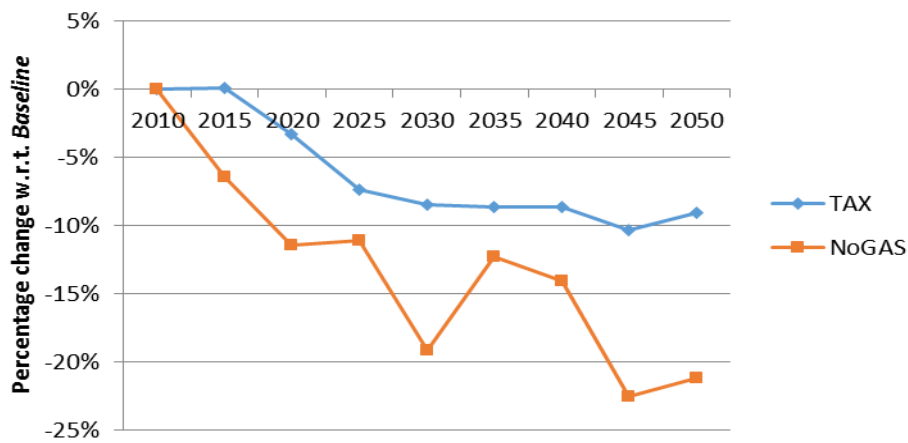

Figure 61: Average electricity cost (TAX) relative to Baseline

As mentioned in section 3.1.3.4, the marginal cost of electricity does not vary between the *TAX* and *Baseline* scenario, with the average cost being even lower for the *TAX* scenario compared to the baseline. This implies that the lower electricity demand in the *TAX* scenario is not due to the price feedbacks from the bottom-up model (CROSSTEM-CH), but instead driven primarily by the electricity tax applied within the CGE model (GENESwIS).

3.1.3.6 Welfare and consumption

Due to the introduction of environmental policies in the *TAX* and *NoGAS* scenarios, welfare is decreased with regard to the baseline (Figure 62). This welfare reduction is not very pronounced ($\leq 0.1\%$), and it is unlikely that it originates from the simulated electricity tax, because we assume its revenue to be recycled through the income tax (equal yield constraint). Hence, it does not greatly alter the total excess burden of the tax system. The welfare reduction is mainly due to the increase of the CO₂ tax, as its revenue is recycled through the buildings program (subsidy of 280 mio CHF) and lump-sum transfers. However, this welfare reduction appears only, because we neglect the benefits of reduced climate change as well as side benefits of abatement, such as health improvements due to reduced air pollution.

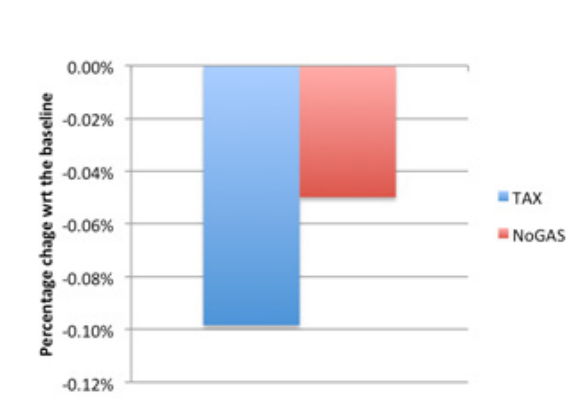

Figure 62: Percentage change of welfare with regard to the baseline for the TAX and NoGAS scenarios.

We observe that the welfare reduction is smaller for the *NoGAS* scenario than for the *TAX* scenario. As the simulated market instruments are the same in both scenarios, the difference must lie in the prohibition to use natural gas power plants and in the relaxation of the net trade constraint.

In the *NoGAS* scenario, although the marginal cost of electricity (and hence the price of wholesale electricity) increases compared to the *TAX* scenario, the total system cost is much lower (Figure 60 and the explanations that come with it).

To understand the impact on welfare of these two results, we must analyze the way wholesale electricity is priced. It is priced at “long-term” marginal generation cost, i.e. it reflects the shadow price of the binding constraint in the CROSSTEM-CH model, taking into account all cost components of the system, including for example capital costs for new investments. In GENESwIS, generation costs are correctly linked to average generation costs from CROSSTEM-CH. Marginal pricing in the wholesale market thus creates a profit. In the model, the markup over the average costs is set such that it represents the difference between CROSSTEM-CH’s marginal and average costs (see 3.1.1.3.2). Although the profit has to be paid for by electricity users, the money remains in the economic cycle, because it is an income of the representative agent. Consequently, overall welfare is not affected by the profit as much as one might expect from simply looking at the increased wholesale electricity price in Figure 53. As we have only one representative household, we neglect distributional effects between capital owners of electricity generation plants and other households, which of course do play a role in the real world.

Now that we have brought to mind that the wholesale electricity price consists of the two components (1) average generation cost and (2) profit, we are able to analyze the welfare effects more clearly:

- The first component of wholesale electricity, the average cost, is reduced in the *NoGAS* scenario compared to the *TAX* scenario. This cost saving effect is translated into an increase in welfare.
- The second component, the profit, increases due to higher marginal costs (and hence higher wholesale electricity prices) as well as lower average costs. The increased profit results in a welfare loss, because it effectively works like a tax with lump-sum recycling to the representative agent. However, this welfare loss is not the result of a policy-induced distortion, but related to a natural feature of competitive pricing under diminishing returns to scale.

It is an important advantage of the ELECTRA-CH framework that it explicitly models the shape of the sectoral cost function at every moment. Because of this, costs, prices and profits can be determined more precisely. Interestingly, we find in this case that prices increase although total system cost decreases, which is a direct consequence of the technologies selected by CROSSTEM-CH. Such analysis is impossible with a stand-alone CGE model, at least when it relies on homogeneous, i.e. constant returns to scale, nested CES production functions.

The combined result of the effects for the two price components is an increase in welfare in the *NoGAS* scenario compared with the *TAX* scenario. Calculated from GENESwIS, the total increase in welfare in discounted value terms in the *NoGAS* scenario with respect to the *TAX* scenario amounts to 1.05 bio CHF₂₀₁₀. CROSSTEM-CH displays a difference in total system cost of roughly 2 bio CHF₂₀₁₀. The comparison between these two numbers illustrates that general equilibrium effects are non-

negligible. In this particular case, the most important of these is that higher electricity prices induce substitution away from electricity. This may be regarded as desirable, due to external effects. Neglecting these external effects, however, the resulting changes in consumption eat up most of the welfare advantage connected to lower total costs of the electricity system. We would not be able to find such effects in a pure bottom-up energy system model. Nor would we have found this particular effect in a standard CGE without coupling it to a bottom-up electricity supply model.

The impacts of the diminution of total system cost and increase of electricity prices can also be felt in the development of total consumption over time. For the tax scenario, we can see in Figure 63 that total consumption is progressively reduced from 2020 onward with respect to the baseline. As explained above, this is mostly due to the CO₂ tax. For the *NoGAS* scenario, the lower electricity system cost in all time periods shifts the consumption curve upward. In the figure, we directly observe this effect especially for the earlier years. For the later years, the electricity price increase (Figure 53), which is much stronger from 2030 onward, bends the *NoGAS* consumption curve back down.

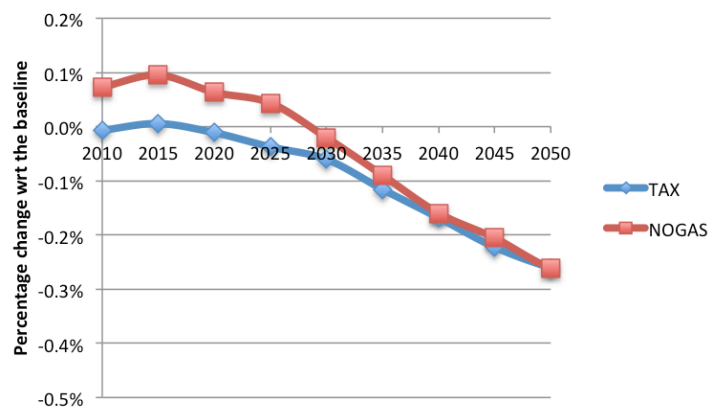

Figure 63: Variation of consumption with regards to the baseline for the TAX and NoGAS scenarios.

3.1.3.7 Sectoral effects

The environmental policies of the *TAX* scenario affect the energy sectors the most (Figure 64). We observe a reduction of production for the Natural gas, Refineries and Electricity sectors with regard to the baseline. The increase in production of the District heating sector, and to a smaller extent of the Construction and Cement & concrete sectors, are due to a substitution of heating fuels into District heating and insulation (provided by the construction sector). In GENESwIS, Cement & concrete are demanded by the Construction sector and for export only, which implies that output changes for the Construction sector usually induce similar output changes for Cement & concrete. While in reality some insulation is achieved with thicker and/or improved concrete walls, we may have overestimated the positive effect on the Cement & concrete sector due to the usual homogeneous commodity assumption for CGE models, which also applies to Construction. The prohibition of gas power plants in the Electricity generation sector for the *NoGAS* scenario causes a large reduction in demand for natural gas. Also, due to the wholesale electricity price increase, demand for electricity, and hence electricity generation is further reduced in the *NoGAS* scenario compared to the *TAX* scenario.

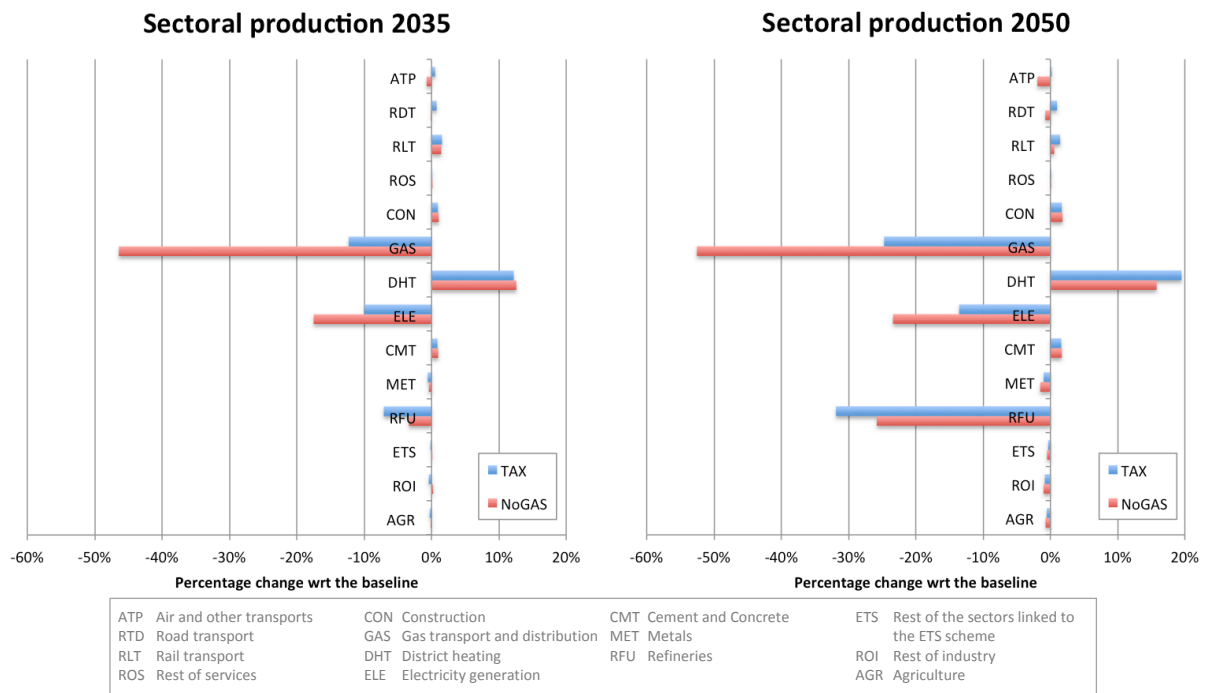

Figure 64: Sectoral production - variation with regards to the baseline - for the years 2035 and 2050.

The natural gas restriction of the *NoGAS* scenario also affects the output of the Refinery sector. Its output increases slightly with regard to the *TAX* scenario. This is the combined result of two opposing effects:

- The electricity price increase makes e-mobility and electric heat pumps less attractive and more transport and heating fuels are used compared with the *TAX* scenario (larger effect).
- As gas power plants are prohibited in electricity generation, natural gas becomes more attractive to other sectors and households. Although there is no extraction of natural gas in Switzerland and world market prices are exogenous, prices slightly decrease for domestic natural gas transport and distribution. This somewhat accelerates the replacement of oil heaters (smaller effect).

3.1.3.8 Foreign trade

In GENESwIS, foreign trade is modeled such that domestic and foreign goods are imperfect substitutes (see section 2.2.2.4). In the CROSSTEM-CH model, international electricity trade is governed by the minimization of total system cost, taking into account exogenous import and export price assumptions. In the coupled framework, CROSSTEM-CH’s representation of foreign electricity trade is prioritized over GENESwIS’s.

For sectors other than electricity, changes in net trade as a share of output are unimportant across the different scenarios. As there are sizeable output changes in some sectors, trade volumes do change, but net trade as a share of total output generally remains unaffected (see Figure 65; for a clearer view of the graph, the non-energy sectors have been aggregated; anyway, the three lines appear almost as one single line). This indicates that within our modeling framework, the simulated policies generally do not produce large international competitiveness issues.

The picture for electricity trade could not be more different. This is, because CROSSTEM-CH's optimization in the *Baseline* and *TAX* scenarios uses the opportunities for reducing total system cost by achieving net revenues from foreign trade, which increase until 2035. Domestic electricity taxation in the *TAX* scenario reduces domestic demand (although not the wholesale price of electricity) and thus increases the share of exported electricity relative to the *Baseline* scenario (see Figure 65). In the *NoGAS* scenario, the more restricted choices for domestic generation lead to a net import of electricity in 2035 and 2040, i.e. immediately after the nuclear phase out. By 2045, Switzerland becomes a considerable net exporter of electricity again, on the basis of newly installed solar capacity. Whether the net imports in 2035 and 2040 become necessary, is likely to depend on the rate of efficiency improvements and related capacity growth for solar generation technologies.

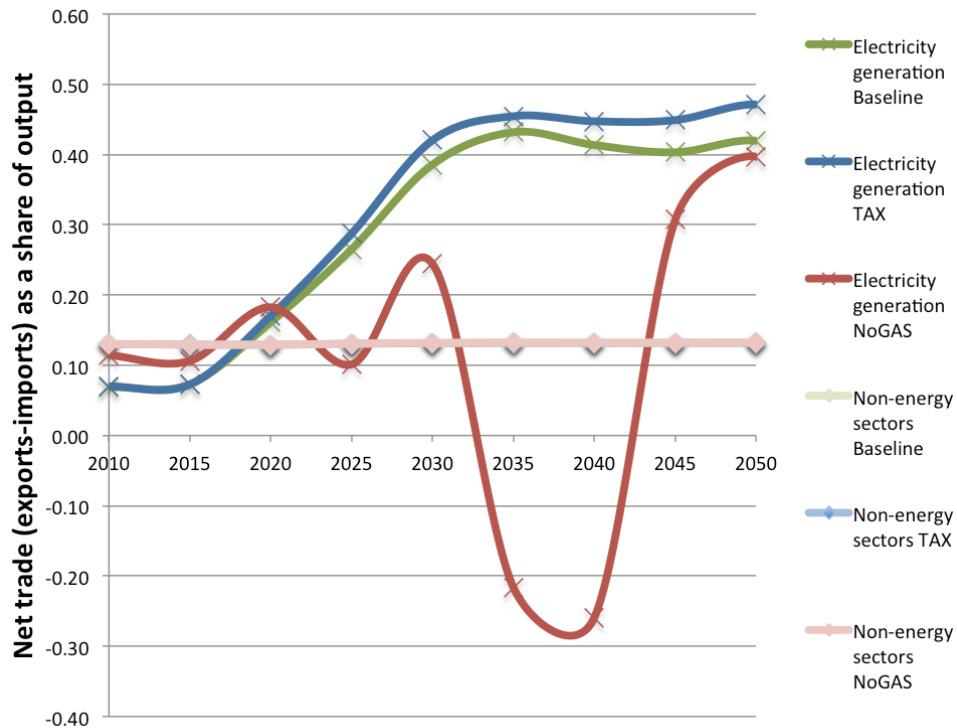

Figure 65: Net foreign trade (exports-imports) as a share of output for the electricity sector for the *Baseline*, *TAX* and *NoGAS* scenarios.

3.1.3.9 CO₂ emissions

CO₂ emissions from the electricity generation sector for all the scenarios are given in Figure 66, for the different scenarios. For both the *Baseline* and *TAX* scenarios, there is an initial increase in the CO₂ emissions, reaching a peak value of 10.8 Mt CO₂ in 2045 for the *Baseline* scenario, and 7.6 Mt CO₂ in 2040 for the *TAX* scenario. Increasing gas prices combined with the higher CO₂ tax result in increasing technology penetration from solar PV, which lowers the emissions by 2050. The *NoGAS* scenario clearly will not have any CO₂ emissions (grey CO₂ emissions due to increasing electricity imports are not represented here).

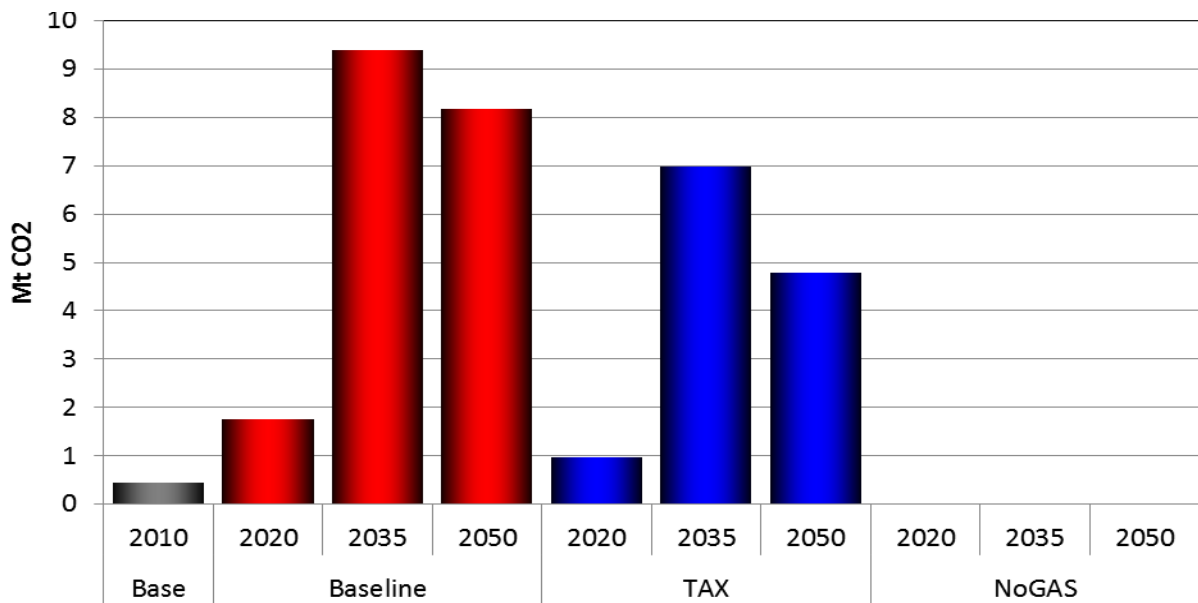

Figure 66: CO₂ emissions (Electricity sector)

For the economy as a whole, we observe an even greater decrease in fuel-related CO₂ emissions for both policy scenarios relative to the baseline (Figure 67a). This is the expected outcome for scenarios that include a CO₂ tax. The restriction on gas power plants in the *NoGAS* scenario brings the total emissions down further with regard to the *TAX* scenario.

It is however interesting to note the presence of a substitution effect: Although the prohibition of gas-fired power plants decreases total CO₂ emissions, CO₂ emissions from the other sectors (excl. electricity generation) increase relative to the *TAX* scenario (Figure 67b). This is mainly, because higher electricity prices in the *NoGAS* scenario discourage the switch from heating and transport fuels to electric systems.

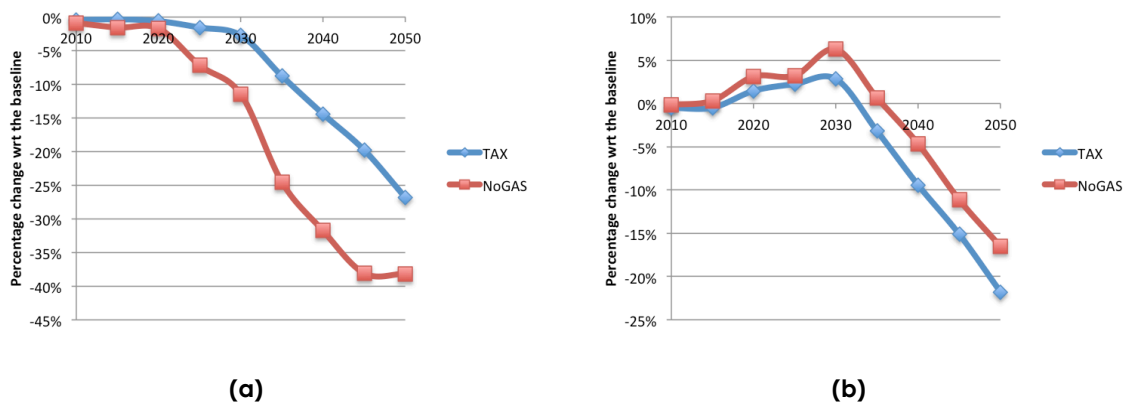

Figure 67: Percentage variation with regard to the baseline of CO₂ emissions from fuels for - a) all sectors including electricity generation and b) all sectors excluding electricity generation – for the *TAX* and *NoGAS* scenarios.

Analyzing the CO₂ emissions paths by fuel, we observe an interesting consequence of policies timing:

In the *TAX* and *NoGAS* scenarios, the CO₂ tax on heating fuels is increased from 2020 until 2050. An electricity tax is introduced in 2020, increasing until 2050. Transport fuels, in contrast, are taxed through the CO₂ scheme only from 2035 onwards. For a more detailed presentation of the policy scenario, please refer to section 1.4.1.

The different timings of the CO₂ policies affect the respective fuel demands and related emissions. CO₂ emissions from light heating oil are reduced from 2025 onward, due to the CO₂ tax (Figure 68). We notice a slight increase of CO₂ emissions until 2020 due to inter-temporal effects. For natural gas, the emission reduction is somewhat delayed (Figure 68). Although natural gas is a fossil fuel, its emission intensity is lower than for heating oil. This implies that under a CO₂ tax, there is not only substitution away from natural gas, but also some substitution from oil to gas heating, especially as long as there is still a sizeable share of existing oil heaters.

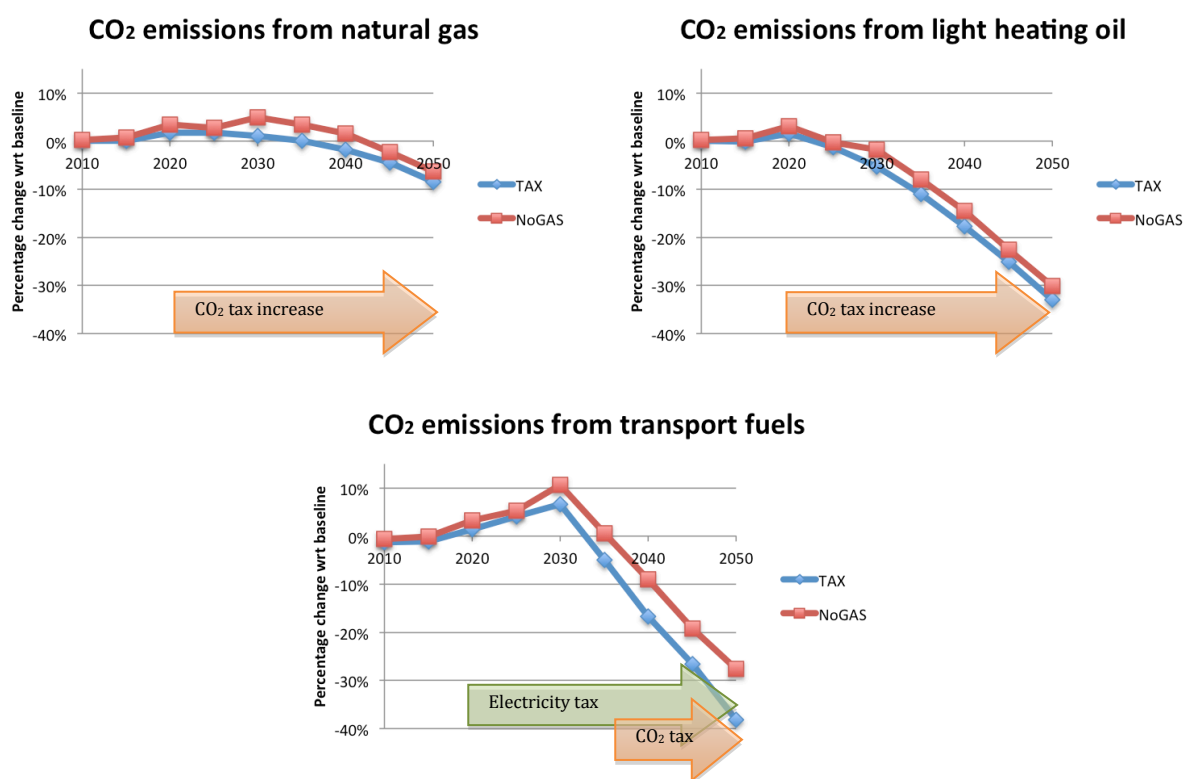

Figure 68: Percentage variation with respect to the baseline of CO₂ emissions from fuels (transport fuels, heating fuels and gas) for all sectors excluding electricity generation.

The CO₂ emissions from transport fuels increase until 2030 compared to the baseline (Figure 68). As electricity is taxed earlier, i.e. from 2020 onward, the switch to e-mobility is somewhat discouraged, and more transport fuels are continued to be used. Once transport fuels are also taxed, this effect is reversed, and e-mobility becomes more attractive. This effect is quite strong in our model, because of the high elasticity of substitution that we had to assume between e-mobility and transport fuels (see 2.2.3.1). In reality, the effect might be smaller. However, our simulation results demonstrate at least qualitatively that the timing of policies is crucial for the market penetration of new and cleaner technologies.

3.1.3.10 Comparing results from the coupled ELECTRA-CH framework with results from stand-alone models

3.1.3.10.1 Comparing coupled ELECTRA-CH results with CROSSTEM-CH results

During the coupling process, we include, in the extent possible, sectoral prices feedback from the GENESwIS model. This is done with the help of price-variation coefficients (see section 3.1.1.4.2) that affect capital investments as well as O&M costs of various technologies. These changes have an effect on the technology choice as shown in Figure 69. The figure compares a coupled run of the TAX scenario to an uncoupled independent CROSSTEM-CH run using the TAX scenario demands, but without multiplying investment and O&M cost with the price-variation coefficients (shown in Figure 70 for the TAX scenario). As seen from Figure 70, the investment cost for gas and hydro technologies are higher during the initial time periods, but then decrease towards the end of horizon (variations are small, within $\pm 2\%$). The O&M costs for gas plants do not change much over the same time period, whereas they increase considerably (up to 6% by 2050) for the hydro technologies. This implies that for a coupled run, the cost of operating hydro technology is higher than for an uncoupled run. This is reflected in the generation mix, which shows a higher output from pumped hydro (which is the most expensive hydro option available) for the uncoupled run compared to the coupled run. To overcome this lost flexibility, the coupled model invests in more flexible gas generation technology (in 2035, 30% of the total gas based generation comes from flexible gas plants in the coupled run, compared to 14% in the uncoupled run). Similar patterns are observed for the other two scenarios as well.

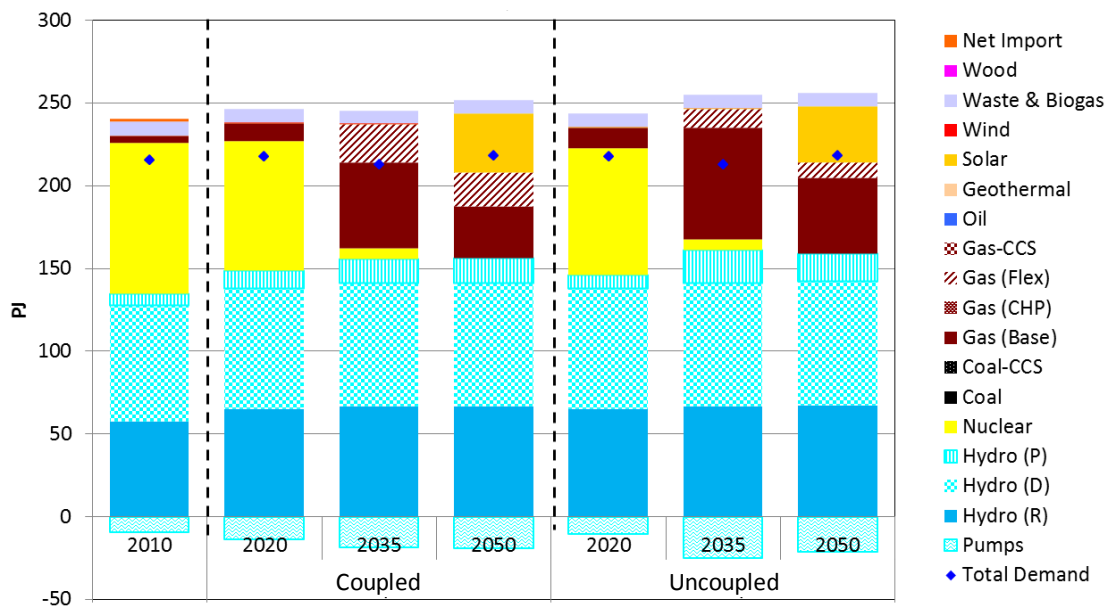

Figure 69: Electricity generation mix (Switzerland - TAX) - Coupled vs uncoupled

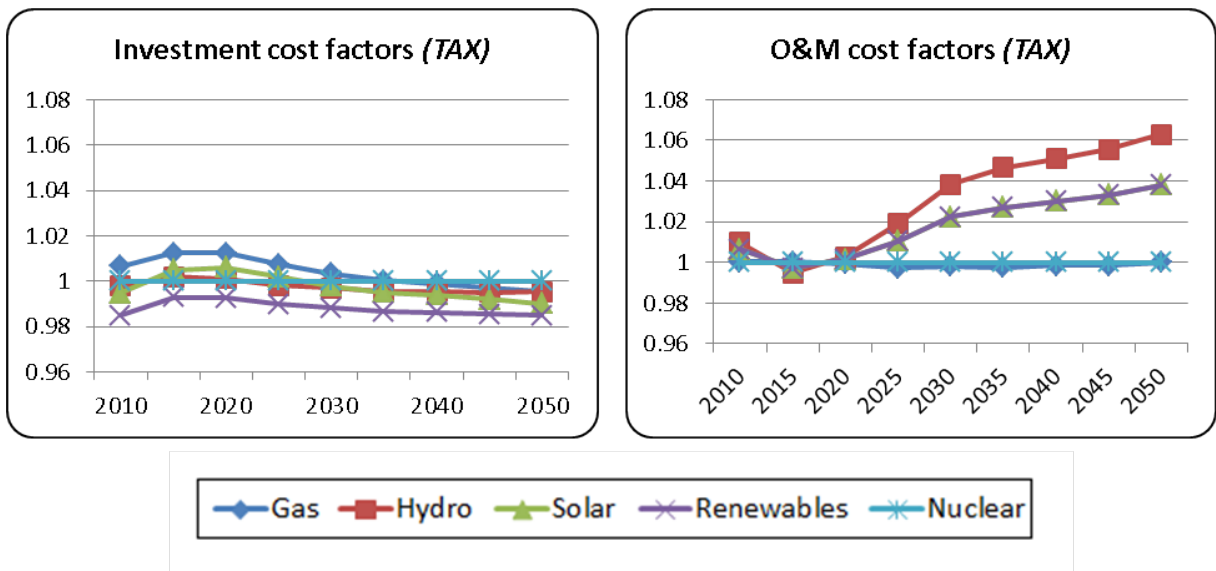

Figure 70: Price-variation coefficients for the TAX scenario.

3.1.3.10.2 Comparing coupled ELECTRA-CH results and GENESwIS results

The following comparison between the coupled ELECTRA-CH results and GENESwIS stand-alone results serves to illustrate some of the differences in behavior which arise from the methodological differences in the representation of electricity supply. Before we present this comparison, however, we need to identify the limits of this comparison: The results presented in this section should not be compared quantitatively. Hence, we merely explain why and how the two models behave differently, which demonstrates some important advantages of the coupled ELECTRA-CH framework.

For the comparison, we use the same version and calibration for GENESwIS stand-alone as in the coupled framework except for the following: For the coupled framework, we calculate input shares for electricity generation from the CROSSTEM-CH technology mix. In the stand-alone version, we replace this information by the input shares given by the Swiss energy input output table, just as it is usual practice for CGE modelers. This approach has the advantage that we compare two models which are as similar as possible in terms of the CGE model's structure and calibration.

Generally, every calibration decision also has its disadvantage. In this case, the disadvantage is that the GENESwIS stand-alone model that we employ is not the model that we would usually put forward as the ideal CGE representation: The GENESwIS model used in the coupled framework was modified to suit the economic and technical requirements for the coupling. Mainly, the representation of the electricity sector is set as a Leontief function to take CROSSTEM's results as direct inputs. For a stand-alone CGE model, this representation of the electricity sector lacks some important opportunities for substitution and is thus somewhat too restrictive. Secondly, using the same GENESwIS parameters for calibration (with the exception given above), the different methodologies imply that we cannot expect to exactly meet the baseline quantity paths that the coupled framework is calibrated to conform with. To minimize the impact of these discrepancies, we present the results in percentage changes with regard to the respective baselines.

Figure 71 shows the comparison of total electricity demand variation between the *TAX* and *Baseline* scenarios for both GENESwIS stand-alone and the coupled ELECTRA-CH framework. In both models, the tax-induced increase in the user price of electricity reduces demand. However, the magnitude of the demand reaction is strikingly different. This is although the tax rates and also the representation of demand are the same. The difference is thus in the representation of electricity supply: GENESwIS stand-alone shows the behavior that we would also expect from a simple partial equilibrium analysis (see Figure 72): A tax introduces a wedge between producer (net) price and user (gross) price and thus typically increases the gross price. However, along usual demand and supply functions we reach a new equilibrium with lower quantities, a higher gross price, but a lower net price. In the ELECTRA framework, in contrast, electricity prices net of tax hardly move between the two equilibria, because the marginal generation cost remains almost the same for this particular scenario. For the *TAX* scenario, the gross price of electricity is thus remarkably higher in the ELECTRA-CH framework than in GENESwIS stand-alone (see Figure 73), which is directly linked to the technological representation of electricity supply in CROSSTEM-CH. The different gross user prices translate into differences in total electricity demand.

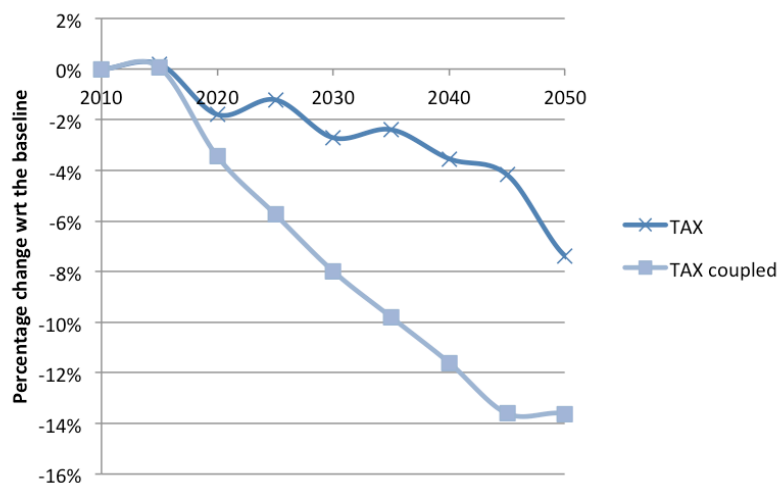

Figure 71: Comparison of total electricity demand variation for the *TAX* scenarios relative to baseline scenarios for the stand-alone GENESwIS model (*TAX*) and for the coupled ELECTRA-CH framework (*TAX coupled*).

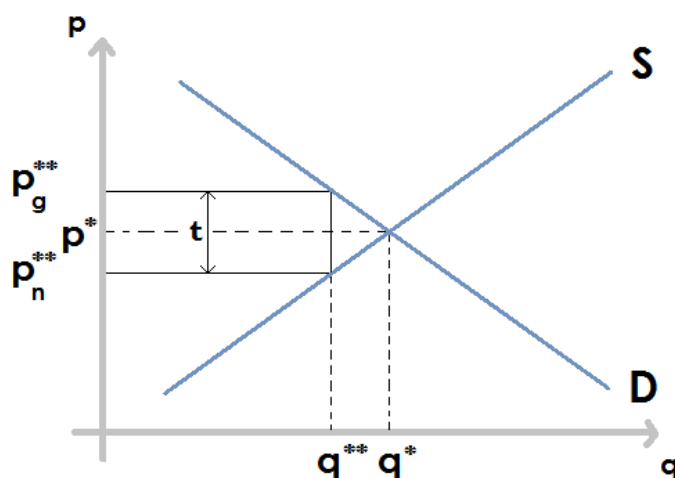

Figure 72: Graphical static partial equilibrium analysis for the introduction of a tax.

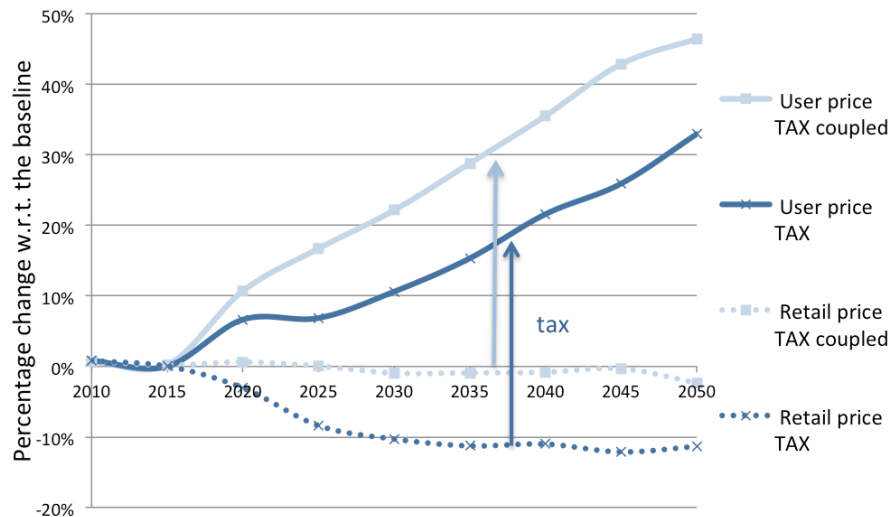

Figure 73: Retail (net of tax) and user (gross of tax) electricity prices for the TAX scenario relative to the baseline scenarios for the stand-alone GENESwIS model and for the coupled ELECTRA-CH framework.

The above differences, which arise from the modeling of electricity supply, are transmitted into the general economy and are reflected in macroeconomic indicators. For example, the comparison of consumption paths (Figure 74) is also instructive. In the later years, total household consumption is reduced more for the coupled ELECTRA-CH framework than in GENESwIS stand-alone. Lower electricity demand as shown in Figure 71 is a related element in this, but the main explanation is in the profits that arise from wholesale electricity pricing (for an explanation on the effect of wholesale electricity pricing on welfare and consumption, see section 3.1.3.6). The difference between average cost and marginal cost, and hence the profit, is larger in the later periods, which reduces the consumption possibilities for the representative household, as shown in Figure 74.

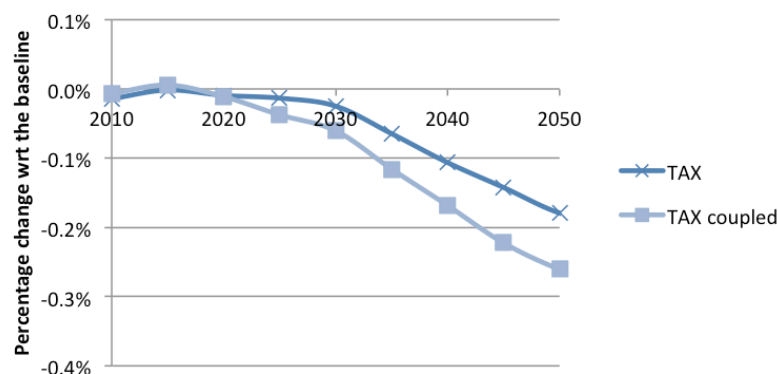

Figure 74: Comparison of the variation of consumption between the TAX and Baseline scenarios for the stand-alone model (TAX) and the coupled ELECTRA-CH framework (TAX coupled).

This short comparison of central indicators confirms that coupling matters. In results and functioning, the coupled ELECTRA-CH framework is clearly different from either stand-alone model. Basically, the ELECTRA-CH framework is a new model that strives to combine the analytic potentials of its bottom-

up and top-down model components. This creates opportunities for more profound policy analysis and greatly improves the understanding of supply and demand interrelations. The fruits of any such modeling advancement can only be reaped when the new model framework produces dependable results that are driven by traceable effects. In the current chapter 3.1, we have demonstrated that ELECTRA-CH has these important properties.

3.2 ELECTRA: Coupling CROSSTEM, GENESwIS and GEMINI-E3

This section concerns work in progress. It presents the current state of affairs on coupling CROSSTEM, GENESwIS and GEMINI-E3 to create an ELECTRA framework with an explicit representation of foreign countries in both the bottom-up electricity supply component and in the top-down multi-sectoral CGE part. The goal of this coupling is to extend the framework such that it fully reflects the high level of Switzerland's integration into international commodity markets and the European electricity grid. Among other things, this framework would enable us to also simulate the impact of foreign climate and energy policies on the Swiss economy in general and on the Swiss electricity sector in particular.

The ELECTRA framework is composed of three component models that are to be coupled through a soft link:

- CROSSTEM, the cross-border TIMES electricity supply model, provides the technological details of electricity supply and trade for Switzerland and its neighbouring countries (see section 2.1).
- GENESwIS, the dynamic general equilibrium model of Switzerland, models the entire Swiss economy, taking into account inter-sectoral feedbacks (see section 2.2).
- GEMINI-E3, the multi-regional general equilibrium model of international-national interactions between economy, energy and the environment, adds the global trade dimension to the framework and the possibility to explicitly model market instruments of international policies (see section 2.3).

In this chapter, we motivate the development of the ELECTRA framework (section 3.2.1) and introduce the methodology applied to couple the models (section 3.2.2). In section 3.2.3, we present the current state of affairs and identify the latest issues. Finally, we propose next steps in section 3.2.4.

3.2.1 Motivation

Simpler models are most of the time preferred to larger and complex ones, as they are easier to build and interpret. Despite this, there are very good reasons for expanding the ELECTRA-CH framework to the larger ELECTRA framework:

Switzerland is a small economy that is closely interlinked with Europe and the rest of the world. Although Switzerland may not have a noticeable impact on the rest of the world (although, this may not be fully true for the electricity sector), the rest of the world influences to a great extent the Swiss economy through trade.

This inter-linkage is even more pronounced for the electricity sector. Indeed, with the liberalization of the electricity market, electricity is traded all across Europe. It is traded extensively, from long-term contracts, negotiated years in advance, to short-term trading through spot and intraday markets. Furthermore, electrons know no international borders. The electricity grid is actually one grid, although some parts can be sectioned-off in case of an emergency. Additionally, with the appearance of renewable technologies, the inter-connection of the whole European network becomes more and more important. The Swiss electricity market can thus not be analyzed adequately without a sound representation of its integration into the European electricity market.

In principle, international integration can be modeled through exogenous assumptions (import and export prices, world energy prices, CO₂ price etc.), which is the case in the ELECTRA-CH framework. This is perfectly fine when analyzing Swiss policies. However, to adequately simulate impacts of international climate and energy policy scenarios, exogenous assumptions are often not sufficient.

As bottom-up models do not have the ability to model market instruments appropriately, a multi-regional CGE model (here GEMINI-E3) is needed to simulate such international policies. For example, CO₂ prices can be implemented only exogenously in the CROSSTEM model. Endogeneity of CO₂ prices is important, however, as policies as the emissions trading scheme involve CO₂ emission reduction goals in terms of absolute emissions (caps). In countries like Germany or Italy, the electricity sector, which is part of the ETS, has non-negligible impacts on the total emissions from ETS sectors. Hence, variations in the electricity mix may greatly influence CO₂ prices.

In connection with international policies, the electricity mix in neighbouring countries affects Switzerland also directly through electricity markets. This is where the full CROSSTEM model with endogenous trade comes to its full potential: EU policies affect the composition of the electricity mix in the EU Member States and indirectly also in Switzerland.

For simulating and understanding these effects, exogenous trade prices are not informative enough. As can be seen in Figure 31 in Section 2.1.12.1, trade prices assumptions differ compared to simulated trade prices. While the exogenous assumptions do not need to be wrong, they typically do not fully correspond to the modeling structure and scenarios of the current project. The endogenous simulation of trade prices is the much more consistent approach, provided that the model framework represents well the electricity systems of the countries involved. For the scenarios of this project, the seasonal variations embedded in simulated trade prices significantly alter the results for the technology mix. For example, solar becomes less attractive with endogenous trade prices, because export prices are lower in summer. It is replaced by flexible gas power plants which can take advantage of high winter prices (see Figure 30 and the explanation in Section 2.1.12.1).

International policies affect the Swiss economy through further transmission mechanisms:

- CO₂ price: If Switzerland joins the European emissions trading scheme (as we assume in our scenarios), EU (climate) policies affect CO₂ prices also for the Swiss sectors that are affiliated to the Emissions Trading System (ETS).
- Fuel prices: International climate policies affect fuel prices, which are important determinants for energy efficiency and the pace of fuel switch in Switzerland. A change in fuel prices thus also affects the Swiss electricity sector (directly, if gas power plants are implemented, or indirectly through demand shifts).
- Terms of trade: Differences in environmental and climate policies between countries affect the cost structure and competitiveness of energy-intensive sectors. This can change world market prices also for certain non-energy commodities and thus influence the terms of trade for Switzerland.

In conclusion, the ELECTRA framework, including

- an explicit representation of electricity supply in Switzerland and the neighbouring countries,
- international electricity trade based on endogenous prices,
- a general equilibrium representation of Switzerland, the neighbouring countries, the rest of Europe and the rest of the world, and hence,

- the possibility to explicitly model Swiss, European, and international policies

endogenizes further important aspects for energy policy analysis, and it is especially needed when analyzing scenarios with a focus on the impact of foreign policies on the Swiss electricity sector and general economy.

3.2.2 Coupling methodology

As described above, the ELECTRA framework consists of three component models (CROSSTEM, GENESwIS and GEMINI-E3), coupled through a soft link. We can divide the coupling of the models into three steps:

1. CROSSTEM is coupled to GEMINI-E3. The result of the convergence between these two models provides
 - a. the electricity mix (and related costs) for Switzerland and the neighbouring countries,
 - b. the economic impacts on the neighbouring countries, the rest of Europe and rest of the world,
 - c. which includes the variation of relevant price indicators (mainly CO₂ prices and fossil fuel prices).
2. GENESwIS is updated with world market prices simulated by GEMINI-E3.
3. GENESwIS is coupled to CROSSTEM. The result of the convergence between these two models provides
 - a. the electricity mix (and related costs) for Switzerland and the neighbouring countries,
 - b. the impacts on the Swiss economy.

First, convergence must be reached for each step (mostly 1 and 3; step 2 is a simple harmonization). Second, steps 1 to 3 must be iterated upon until the full framework converges.

In the following, we elaborate on the exchange of variables involved in each step of the process (see also Figure 75).

Step 1: CROSSTEM-GEMINI-E3

Electricity generation costs and their components as well as export revenues and import costs for Germany, France, Austria and Italy are extracted from the CROSSTEM model and translated for the GEMINI-E3 model into a) wholesale electricity prices (for each country) and b) input shares for factors and commodities to the respective electricity generation cost functions. The national electricity demand quantities simulated by GEMINI-E3 are then sent back to become inputs to CROSSTEM. To account for changes in the economy, factor and intermediate input prices from GEMINI-E3 are used to modify the investment costs and operation and maintenance costs of the different technologies in CROSSTEM. This sequence is iterated upon until the vector of quantities of total electricity demanded for each common model period converges. Checks are performed such that demands also converge for each country.

Step 2: GEMINI-E3-GENESwIS

World energy prices (fuel prices) and CO₂ prices in GENESwIS are exogenously fixed to the price levels provided by GEMINI-E3.

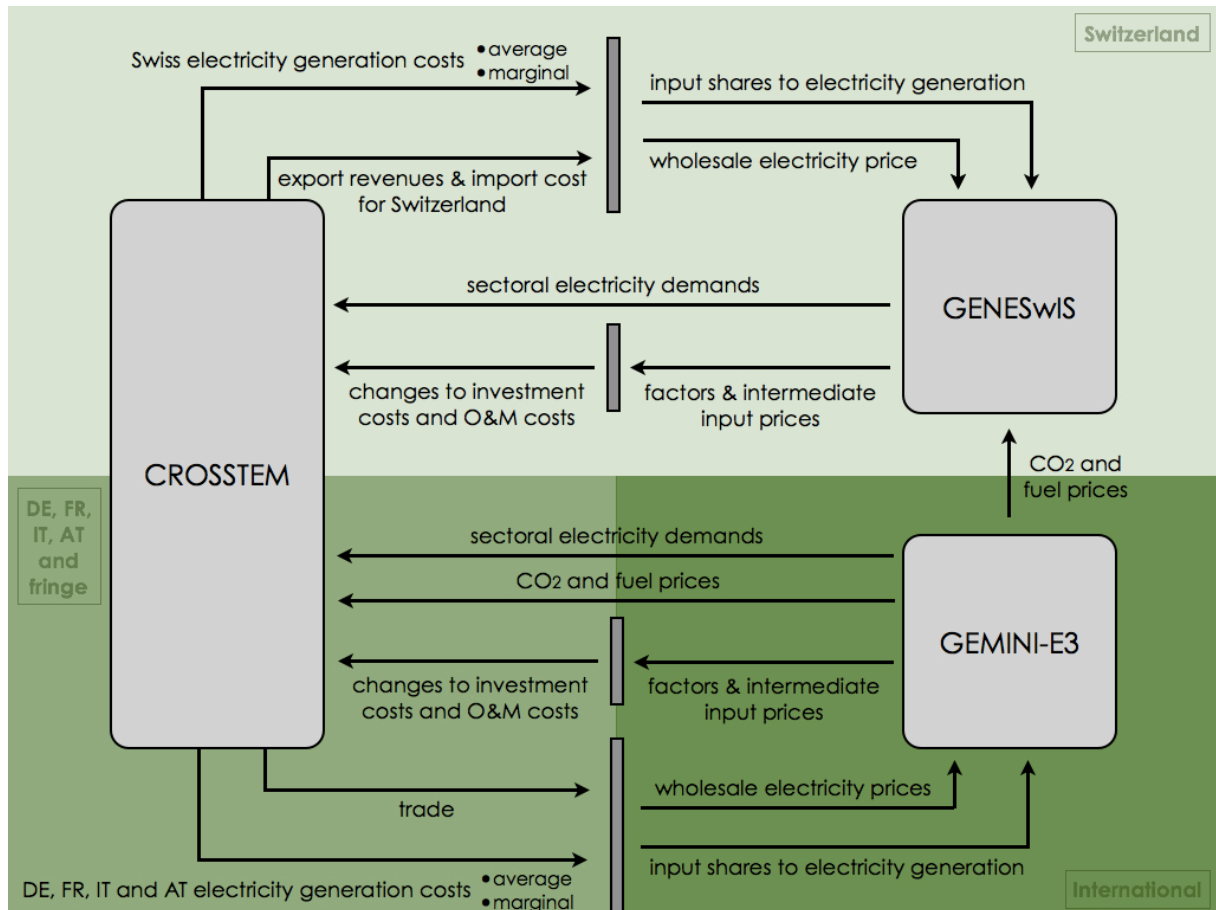

Figure 75: ELECTRA framework: exchange of information between the three component models.

Step 3: GENESwIS-CROSSTEM

Electricity generation costs and their components as well as export revenues and import costs are extracted from the CROSSTEM model and translated for the GENESwIS model into a) the Swiss wholesale electricity price and b) input shares for factors and commodities to the electricity generation cost function. The sectoral electricity demand quantities simulated by GENESwIS are then sent back to become inputs to CROSSTEM. To account for changes in the economy, factor and intermediate input prices from GENESwIS are used to modify the investment costs and operation and maintenance costs of the different technologies in CROSSTEM. This sequence is iterated upon until the vector of quantities of total electricity demanded for each common model period converges.

For steps 1 and 3, the following routines are implemented:

- Link CROSSTEM's costs to CGE's electricity technology and price (see section 3.1.1.3.2).
- Translate CGE price feedback into changes to investment and operation and maintenance costs (see section 3.1.1.4.2).

Before coupling the models, the following procedures are applied:

- Modification of the electricity generation production function in the CGE models (Step 1: see section 3.2.3.2. Step 3: identical to the modifications described in section 3.1.1.3.1 for the ELECTRA-CH framework.).
- Harmonization of the models (Step 1: see section 3.2.3.2.).
- Introduction of a supply elasticity for electricity in the CGEs (see section 3.1.1.5.2).
- Introduction of a dampening of the demand response in the coupling routine (see section 3.1.1.5.3).

3.2.3 State of the coupling

3.2.3.1 Completed tasks

Step 1, the coupling of CROSSTEM and GEMINI-E3, is the most challenging of the three steps. It has thus been the natural starting point. In this respect, the following tasks have been performed:

- Creation of a python script for the exchange of information between CROSSTEM and GEMINI-E3, which
 - runs the CROSSTEM model,
 - extracts CROSSTEM data from a (100Mb) text file with the help of “for” and “if” loops,
 - calculates the required variables (annual fuel costs, capital cost annuities, operation and maintenance costs, import costs and export revenues, inter-connector costs, average cost, annual demand-weighted marginal cost etc.),
 - creates an input file for the GEMINI-E3 model,
 - creates an input file for the GENESwIS model,
 - creates result files for average cost and marginal cost. These files are used to follow the evolution of annual average and marginal costs through the different iterations and check their convergence.
- Creation of a python script for the exchange of information between GEMINI-E3 and CROSSTEM, which
 - runs the GEMINI-E3 model,
 - extracts the results,
 - calculates the dampened demand to be sent according to the Gauss-Seidel equation,
 - writes into the input files (.dd) of the CROSSTEM model to modify the electricity demands as well as fuel and CO₂ prices. The routine involving changes of investments and O&M costs from factors and commodities prices feedback is not yet operational, because we should first reach convergence before adding more complex exchanges which have only minor impacts on electricity prices.
 - creates result files for the electricity demands (total, and for each neighbouring country) and wholesale electricity prices (for each neighbouring country). The demand files are used to compile the convergence criterion (total demand) and to check convergence for each country. The wholesale electricity price files are used to check

that the costs of the CROSSTEM model are translated adequately into wholesale prices (they must be equal at convergence).

- Creation of a main python script for the CROSSTEM-GEMINI-E3 coupling, which runs both previous scripts until the convergence criterion for total electricity demand is reached.
- Modifications of the GEMINI-E3 model (see section 3.2.3.2).
- Harmonization of the models.

Convergence issues are discussed in section 3.2.3.3.

3.2.3.2 Modifications of the GEMINI-E3 model

For the purpose of the coupling with CROSSTEM and as it is done in the GENESwIS model, we have disaggregated the GTAP electricity sector into two sectors, respectively "Electricity generation" and "Electricity transport and distribution". We assume that the output of the Electricity generation sector is only consumed by the Electricity transport and distribution sector, which distributes the electricity to all users (firms and households) and trades electricity with neighbouring countries.

In contrary to the GENESwIS model, it was not possible to use the Input-Output table to calibrate the two sectors. Indeed the Input-Output tables of the GTAP database do not disaggregate electricity generation and electricity transport and distribution. We implemented the procedure described in Figure 76 to calibrate the electricity generation and distribution sectors:

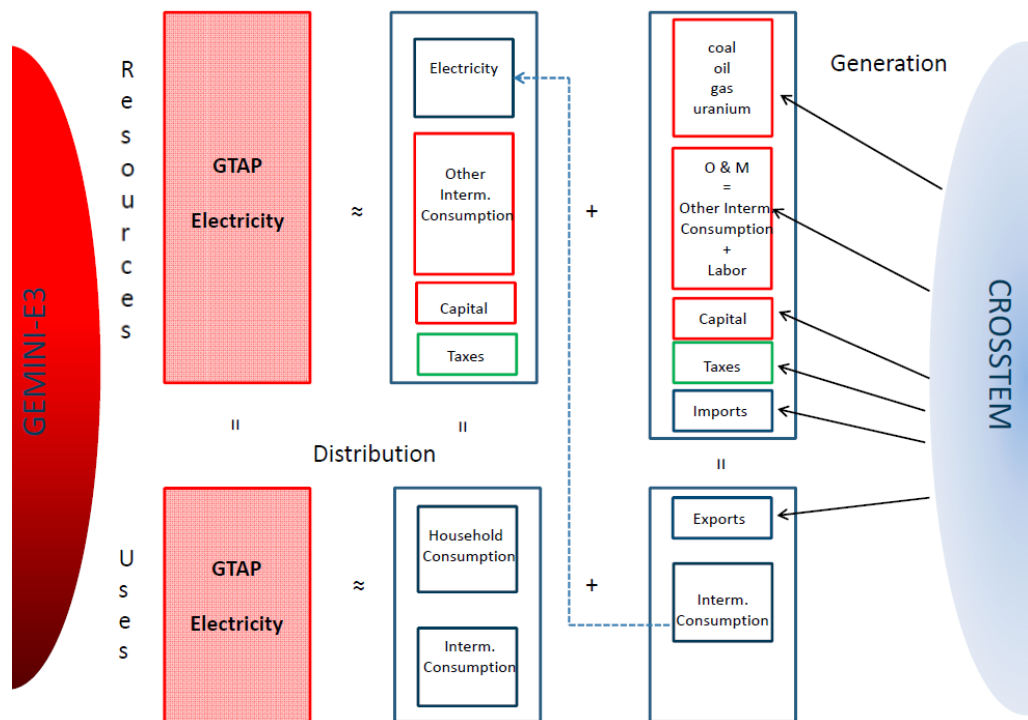

Figure 76: Calibration of the base year in GEMINI-E3 electricity generation and distribution sectors

1. Calibration of the electricity generation sector:
 - a. Fuel inputs (coal, natural gas, oil and nuclear fuels) are equal to the values given by the CROSSTEM database;

- b. Operation and maintenance (O & M) costs are equal to the figures of the CROSSTEM model, they are disaggregated between labor and inputs from sectors 6 to 14 using the shares computed from the GTAP database for the electricity sector as a whole;
 - c. Trade of electricity between countries is also given by the CROSSTEM database;
 - d. Capital remuneration is equal to the capital annuities given by CROSSTEM;
 - e. Taxes on nuclear fuel and fossil energy are computed from CROSSTEM;
 - f. The production level minus imports is assumed to be consumed only by the electricity and transmission sector (minus exports).
2. Calibration of the Electricity transport and distribution sector:
- a. The final uses (excluding exports and imports, which are supposed to be zero) are equal to the figures coming from the GTAP database;
 - b. Energy inputs excluding electricity consumption are equal to zero;
 - c. Electricity consumption is equal to the value of the GTAP database and represents the own uses and losses;
 - d. Other intermediate consumptions are equal to figures coming from the GTAP database minus the intermediate consumptions by the electricity generation sector;
 - e. The same procedure is applied to labor remuneration (i.e. labor remuneration is equal to labor remuneration of the electricity sector as a whole minus the labor remuneration of the electricity generation sector);
 - f. VAT and other indirect taxes are equal to the GTAP figures;
 - g. The difference between resources and uses is added to the capital remuneration in order to balance the accounting representation of the sector.

At the end of the procedure, the two sectors are balanced but some discrepancies with the GTAP database remain regarding:

- Fossil energy consumption is not balanced at the national level, as the figures are coming from the CROSSTEM database;
- Electricity trade differs from the GTAP figures;
- Capital remuneration of the electricity sector.

The balancing of the economy is performed by solving the GEMINI-E3 model, therefore the representation of the calibration year is slightly different from the one of the GTAP database.

3.2.3.2.1 *Dynamic calibration*

The previous section describes the calibration of the two new sectors that have been introduced in GEMINI-E3 for the year 2007. Furthermore, it was necessary to implement a “dynamic calibration” on the simulation period (2007-2050) to be sure that the two models share a common and consistent view of the future of the European electricity market. The following variables have been harmonized between the two models:

- the price of energy commodities: coal, oil and natural gas,
- the electricity demands.

3.2.3.2.2 *Further modifications to enable the linking of GEMINI-E3 and CROSSTEM*

We follow the methodology that has been developed for the coupling between CROSSTEM-CH and GENESwIS. The energy mix and other inputs (O & M costs, capital remuneration) computed by CROSSTEM are introduced into GEMINI-E3 by removing the nested CES functions representing the production of the electricity generation sector. The CES functions are substituted by Leontief functions where the shares are computed from the CROSSTEM inputs. To disaggregate O & M cost between labor and intermediate consumptions by products (i.e. metals, energy intensive industries, rest of industry, construction etc.), we use the GEMINI-E3 shares.

A similar procedure is applied for the electricity trade; the respective Armington functions are replaced by Leontief functions.

CROSSTEM provides its output for every 5 years (2010, 2015, 2020, ...): As GEMINI-E3 is a CGE with subsequent annual periods, the intermediate annual values are computed by linear interpolations between the periods that are explicitly represented in CROSSTEM.

3.2.3.2.3 *GEMINI-E3 stand-alone versus GEMINI-E3 with energy mix coming from CROSSTEM*

In this section, we present a preliminary coupling that aims to demonstrate the feasibility of the full coupling already demonstrated within the Swiss ELECTRA framework. This coupling is a preliminary step, because only the energy mix coming from CROSSTEM is implemented in the GEMINI-E3 model. It is also a one way coupling, as the demand computed by GEMINI-E3 is not reintroduced into CROSSTEM. Neither is the electricity trade computed by CROSSTEM coupled with GEMINI-E3, which computes electricity trade with its own equations.

We performed two runs:

1. The first one is based on a stand-alone version of GEMINI-E3 but where the representations of the electricity sectors are calibrated with data coming from the CROSSTEM model (see section 3.2.3.2). The nested CES function used for the electricity sectors (generation, and transmission and distribution) retains the substitution elasticities of the GEMINI-E3 standard version.
2. The second one builds on the energy mix of the electricity generation sector as computed by the CROSSTEM model. In this case, we assume that the elasticities σ_{oth} , σ_e and σ_{ef} reported in the Figure 39 are equal to zero (i.e. the three CES functions become Leontief functions). The coefficients representing the shares of the Leontief functions are given by the CROSSTEM model.

The scenarios presented hereafter assume that a carbon price is implemented in the power sector which is equal to the one reported in Table 11. Also, we have harmonized between the two models the world energy prices and the electricity demands. Nevertheless, the models have two different assumptions concerning CCS technology and the German nuclear moratorium. GEMINI-E3 does not integrate any penetration of Carbon Capture and Storage technology, in contrary to CROSSTEM. CROSSTEM assumes that a nuclear moratorium is implemented in Germany, which is not the case in

the GEMINI-E3 runs. Finally, as GEMINI-E3 does not represent explicitly renewable and nuclear power plants, we compare the fossil energy mix computed by the two models (GEMINI-E3 stand-alone vs. the coupled models).

Figure 77 gives for the four countries (Austria, Germany, Italy and France) the fossil energy mix computed by the two models for the years 2010, 2020, 2030, 2040 and 2050.

In 2010, the two models give similar results. Indeed, GEMINI-E3 alone is calibrated from the energy mix coming from CROSSTEM for the calibration year 2007. After the first periods of the simulation, however, the two models diverge and give completely different results. In the long term, CROSSTEM finds a solution where only one fossil energy dominates the electricity generation: coal with CCS. In contrary to CROSSTEM, GEMINI-E3 represents a diversified fossil energy mix in Europe, where coal is gradually replaced by natural gas whose low carbon content limits the impacts of the carbon price. These two different views of the future of European electricity generation come mainly from the availability of CCS in CROSSTEM, which is not assumed in GEMINI-E3. Nevertheless, these simulations demonstrate that CGE models like GEMINI-E3 tend to underestimate the possibility of substitution in comparison to bottom-up models like CROSSTEM, which maybe have a tendency to overestimate this substitution.



Figure 77: Electricity generation fossil energy mix in Mtoe.

At country level, Austria and Italy face similar dynamics. First, the total amounts of fossil energy consumption computed by the two models are similar in the two countries. As we already noticed, in GEMINI-E3 coupled with CROSSTEM fossil energy use is almost fully represented by coal with CCS. In contrary, the GEMINI-E3 stand-alone run shows a mix dominated by natural gas where coal contributes respectively only 33% and 18% to the fossil energy consumption in Austria and Italy.

The German case in the coupled version is mainly driven by the nuclear moratorium where nuclear power plants are replaced by renewables and coal. In contrary, the stand-alone GEMINI-E3 version assumes that nuclear power still contributes to German electricity generation.

In France, the two models find that fossil energy contribution to electricity generation remains limited in the future (it is less than 10% in 2012). This contribution is divided by two in the coupled version and mainly represented by coal with CCS. In the stand-alone version this contribution also decreases and remains dominated by natural gas.

3.2.3.3 Trade related issues

The main issue at the time of writing this report is linked to endogenous trade: One of the main features of the CROSSTEM model is that trade is endogenous. All decisions in the model are governed by the optimization of total system cost. Hence, CROSSTEM chooses to trade when it is beneficial for the system as a whole. This decision is linked to the marginal cost of electricity in each country and time slice (see section 2.1.9).

The GEMINI-E3 model does not simulate 288 time slices, but an entire year. Hence, for the coupling, trade must be annualized. This is a simple summation in terms of physical quantities, but non-trivial in value terms, i.e. when prices are involved: Annual import costs and export revenues are equal to the sum over all time slices of the quantity imported (resp. exported) multiplied by the marginal cost of the exporting country. Hence, the import (resp. export) price extracted from the CROSSTEM model can be calculated as the import-weighted (resp. export-weighted) average of the exporting country's marginal cost. As imports do not happen in the same time slices as exports (or at least not in the same quantities), the average import price is not the same as the average export price, which in turn will not be equal to the wholesale electricity price (calculated as the annual demand-weighted average marginal cost of electricity). We hence have, for each country, three different prices: import price, export price, and wholesale electricity price (incl. net trade).

In GEMINI-E3, there is only one (wholesale) electricity price in each country for a given year. When, for example, Germany imports electricity from France, it pays the French wholesale electricity price. This is a direct consequence of annual time periods and product homogeneity in the CGE model.

Essentially, the question is: What characterization of trade do we prioritize from the CROSSTEM model:

- a. trade volumes (quantities)
- b. or net trade revenues (values)?

Prioritizing trade volumes implies that wholesale electricity in GEMINI-E3 will not reflect exactly CROSSTEM's costs as put forward in the methodology (see 3.1.1.3.2). This is not the case when we prioritize trade costs (in value terms). However, the CROSSTEM model is calibrated on physical quantities, and hence these might be the more relevant indicator.

The issue of trade prices leaks into the harmonization of the models. In 2010, the calibration year for the CROSSTEM model, marginal costs are quite high, due to constraints in CROSSTEM which need to be added for calibration. As a result, import costs and export revenues are quite high relative to other years (although trade volumes are similar). As 2010 data is used to calibrate/harmonize the GEMINI-E3 model, this poses a problem.

3.2.4 Further research

The next steps for creating the full ELECTRA framework involve the following tasks:

Step1: Coupling GEMINI-E3 with CROSSTEM

- Solve the trade issue (especially: decide on prioritization of volume or value).
- Further improve the harmonization of the models.
- Solve next problems arising:
 - We could expect some issues due to the different inter-temporal nature (fully dynamic and dynamic recursive) of the models.
 - We could also envision some issues coming from the fact that the CROSSTEM model optimizes full system cost (the Swiss electricity sector represents a very small share of this cost), while GEMINI-E3 simulates the interaction of nationally optimizing representative agents.
 - For sure, we need to expect issues that we do not expect.
- Once convergence is reached: analyze results. Further modifications may be needed until consolidated results are obtained.

Step 2: Gemini-E3-GENESwIS

- Set GEMINI-E3 CO₂ and fuel prices as exogenous prices in GENESwIS.

Step 3: Coupling GENESwIS with CROSSTEM

- Implement trade the same way as decided for step 1.
- Re-harmonize GENESwIS and CROSSTEM (for Switzerland), taking endogenous trade and modified costs into account.

With convergence for each step, the likelihood for the whole framework to converge is very high. Indeed, the Swiss electricity sector represents a small share of the total system cost. Changes in Swiss electricity demand will not change the electricity mix of the neighbouring countries drastically. Also, the Swiss electricity mix and/or the Swiss economy do not have a (large) impact on CO₂ or fuel prices.

4 Conclusions

The main goal of the ELECTRA research project has been to include international and multisectoral feedbacks as well as general equilibrium effects in the modeling of electricity markets in order to improve model-based energy policy analysis in Switzerland. For this, models had to be updated, enhanced, extended, harmonized and coupled. Although not all of the coupling efforts have already been successful, we can conclude that the project has achieved major breakthroughs for the applied modeling of energy policies in Switzerland. These achievements are represented by the two new modeling frameworks CROSSTEM and ELECTRA-CH.

Accomplishing significant breakthroughs in modeling is always demanding work: including new data, improving model structure, and dealing with numerical challenges. The greatest challenges and most rewarding learning effects, however, have been in the intense interdisciplinary work which is needed to construct a meaningful and reliable coupled modeling framework that consists of very different types of models.

In the simulations with the coupled ELECTRA-CH framework, CGE modelers witnessed how technology-based cost functions introduced profits into their zero-profit world and thus significantly altered equilibrium prices and demands as well as economic welfare. For example, the demand reduction that is prompted by an electricity tax is much more pronounced in ELECTRA-CH than in a stand-alone version of GENESwIS, which also has wider economic consequences in the model.

This result is directly related to the technological options in the Swiss electricity system for the particular scenario (see section 3.1.3.10.2) and not transferable to other scenarios. This singularity only confirms that it is important to explicitly simulate the technological options to be able to understand the working of market instruments in energy policy. On the other hand, the simulation of market instruments is a natural domain of CGE models, which represent flexible prices, options for substitution for households and in the different sectors, as well as intersectoral and general equilibrium effects. Thus, a pure bottom-up approach would not be suitable for studying market instruments either.

Another striking example of the importance of technology-based cost modeling is the welfare improvement that results in ELECTRA-CH from a prohibition of natural gas when net electricity imports are allowed – which at the most correspond to the energy content of the gas that had previously been imported (*NoGAS* scenario). Although imports of electricity and natural gas are qualitatively different in many respects, the favorable outcome of this scenario challenges narrow interpretations of supply security, which anyway become questionable when we observe the implications of the many CROSSTEM figures in this report which depict the intensive foreign electricity trade on an hourly basis.

Interestingly, the reduction in total system cost in the aforementioned *NoGAS* scenario translates into a welfare gain of roughly only half the size, which highlights the importance of modeling the interaction of electricity supply with other sectors of the economy. The diminished welfare gain is attributable to a combination of microeconomic and general equilibrium effects which are explained in section 3.1.3.6. They are relevant for policy-making, mostly because it is important to assess whether a reduction in total system cost translates into price reductions that are beneficial to many

or whether they enhance profits which, at least directly, benefit capital owners of electricity generation plants. From a general equilibrium perspective, this is not yet the end of the story, by far. GENESwIS keeps track of all flows in the economy and hence takes into account, for example, that capital owners use large parts of their income for consumption, which creates income also for others.

In the end, ELECTRA-CH demonstrates clearly that changes in total system cost have a large influence on welfare, but that it is only one of many determinants for the induced welfare changes – and this does not even include external effects of electricity generation, which are also known to be important. The policy-relevant effects that we have sketched here cannot be investigated with either stand-alone model, because CROSSTEM-CH operates with fixed demands and does not consistently translate costs into prices, while GENESwIS's cost functions do not adequately capture the differences between average and marginal costs of electricity supply. Thus, it takes a coupled framework to analyze electricity markets adequately.

Even more, the innovative feature of coupling with marginal cost pricing in competitive markets is indispensable for producing the insights provided by the ELECTRA-CH framework. The usual procedure to couple top-down prices to bottom-up average costs may be simpler to implement and convenient for model convergence, but it is inconsistent with the microeconomic theory for competitive markets, and it neglects the formation of profits due to differences between average and marginal costs. As a result, it miscalculates both the impacts on the rest of the economy and the implications for electricity producers. Section 3.1.2 provides a detailed investigation of this issue to highlight the advantages of the ELECTRA-CH framework in this respect.

For the long-term electricity mix, the results in this report reveal many significant feedbacks from the rest of the economy as well as from developments abroad. In ELECTRA-CH, this includes GENESwIS feedbacks through changes in electricity demands and input prices (see section 3.1.3.10.1). It is noteworthy that endogenizing prices for international electricity trade, as realized in CROSSTEM, has shown to be especially influential for the results (see section 2.1.12). For example, the successful market penetration of grid-connected solar power in Switzerland projected by the CROSSTEM-CH model for 2050 collapses with endogenous cross-border prices in CROSSTEM. As the scenarios in this report have merely been designed to illustrate the functioning of the new model frameworks, any such conclusions are still preliminary and need to be taken with great care. Despite this, the results demonstrate clearly that the additions and enhancements that we have introduced to create the two new modeling frameworks CROSSTEM and ELECTRA-CH matter for energy policy analysis.

To provide further examples, the CROSSTEM scenario analysis shows that exporting electricity produced from solar PV in summer has a limited market for export. It also demonstrates the flexibility of Swiss dam and pumped hydro plants to adapt to increasing renewable based generation in neighbouring countries. Alternatively, in certain scenarios, import of electricity from low carbon sources in surrounding countries becomes cost effective, even though it adds to concerns regarding the security of supply. The impacts of various boundary conditions in the neighbouring countries are well captured by the CROSSTEM framework, which has led to major improvements in the representation of international electricity trade, including the possibility to trace back import and export decisions to the sources of electricity generation and the marginal cost of supply in each region. The above insights would not have been possible with a stand-alone single region model like STEM-E. At least, the methodological basis for taking such conclusions would be shaky.

As for CROSSTEM, the scenario simulations performed with the ELECTRA-CH framework have also provided reproducible results. Although only few scenarios have been analyzed so far, we especially take confidence from the fact that reactions of the coupled system to scenario and parameter changes lead to reasonable results across different simulations. The disadvantage of a large coupled framework is that the testing of a large number of scenarios and sensitivities is more time-consuming. However, to create a robust coupled system, we did have to run a large number of simulations, which helped to gain an overview of different results and a good intuition for the interplay of the coupled system. More specifically, the experience of the design, implementation and testing of the ELECTRA-CH framework provided the following methodological insights:

- A careful harmonization of the models is crucial for framework convergence and for producing dependable results.
- Bottom-up and top-down models are based on different methodologies and different logics. The variables to be linked must be meticulously selected and interpreted, not to introduce inaccuracies or logic flaws in the framework.
- Demand dampening (Gauss-Seidel) is an essential approach for achieving convergence.
- Assumptions on the future evolution of electricity market regulation have an impact on the modeling results.

In addition, the effort on coupling CROSSTEM and GEMINI-E3 unfolded methodological issues due to the different treatment of trade (see section 3.2.3.3): Firstly, the different definitions of import and export prices forced us to abandon the full harmonization of all values, volumes and prices for electricity trades within the coupling framework. Secondly, there are diverging optimization approaches that determine endogenous trade decisions: GEMINI-E3 has one representative household per region, each of which optimizes its utility, while CROSSTEM minimizes total system cost for the five countries, which implies that the outcome will not be optimal for each of the five countries.

In summary, we have developed two new modeling frameworks for energy policy analysis:

- an international CROSSTEM model that has been extended to explicitly include – next to Switzerland – electricity generation technologies in Austria, France, Germany and Italy, including existing capacities and potentials;
- a coupled ELECTRA-CH framework for Switzerland, consisting of the optimizing electricity supply model CROSSTEM-CH and the dynamic computable general equilibrium model GENESwIS.

We have also undertaken major steps towards coupling the extended CROSSTEM model with GENESwIS and with the multiregional CGE world trade model GEMINI-E3, but to date this larger ELECTRA framework does not yet operate. It would permit an even more integrated analysis, especially of the impact of global and EU climate and energy policies on Switzerland. The main advantage of the framework would be to endogenously consider the implications of such policies both on the substitution between energy carriers – including electricity demand – and on the European electricity mix. All of these effects would be simulated both for Switzerland and abroad, such that also impacts that are transmitted through Swiss foreign trade – in electricity and other commodities – would endogenously be taken into account. These worthwhile tasks remain for future research.

The effort to create large coupled frameworks such as ELECTRA-CH and ELECTRA is known to be very large, at least when they entail the necessary structural complexity and a great amount of empirical

data. On the other hand, the simulations with the two existing new frameworks confirm the importance of structurally improving the models that are employed for energy policy analysis. When we adequately include and integrate technological, intersectoral, international, and general equilibrium feedbacks, the economic effects of policies differ not just slightly, but fundamentally, at least for some scenarios. This conclusion can safely be drawn even on the basis of the few scenarios that we have already simulated, because we see the large impacts that structural model changes can have on the results.

The fact that the direction and magnitude of these differences is hard to predict is evidence for the need to use models that are sufficiently complex to capture all of the most relevant effects. An important modeling rule is to keep models as simple as possible. Yet, when the investigated issue is complex, the model needs to incorporate this complexity if it is not to lead to wrong conclusions. In the context of this report's scenarios, exogenous trade assumptions and ceteris paribus assumptions for the rest of the economy have proven to be largely inadequate. Then, the well-known challenge is to ensure that the more complex models still produce dependable results and that the individual effects remain traceable.

More scenarios should be explored in the future to further test and elaborate the model frameworks. This would enable the frameworks to unfold their full potential to generate better-informed answers when investigating the influence of Swiss and foreign energy policies on the electricity mix, electricity prices, and economic welfare, just to name a few. Future simulations with these frameworks can also contribute to a better understanding of the long-term role of Swiss electricity producers in the European electricity system and the implications of this role for policy-makers and consumers. Based on the lessons from additional scenario runs, the two existing modeling frameworks CROSSTEM and ELECTRA-CH can be further enhanced.

References

- Akademien der Wissenschaften Schweiz, 2012. Zukunft Stromversorgung Schweiz. Bern.
- Andersson, G., Boulouchos, K., and L. Bretschger, 2011. Energiezukunft Schweiz. Zürich: ETH.
- Armington, P. S., 1969. A Theory of Demand for Products Distinguished by Place of Production. In: International Monetary Fund 16 (1), 159–178.
- Atukeren, E., Lassmann, A. and Y. Abrahamsen, 2008. Switzerland's electricity trade: a short-term forecasting model and an analysis of multivariate relationships.
- Austrian Power Grid, 2014. Generation Forecast. Retrieved 01/02/2014 from: <http://www.apg.at/en/market/generation/generation-forecast>.
- Badri N., Angel A., and R. McDougall, editors, 2012. Global Trade, Assistance, and Production: The GTAP 8 Data Base. Center for Global Trade Analysis, Purdue University.
- Ban, K. and A. Okagawa, 2008. Estimation of substitution elasticities for CGE models, Discussion Paper 08-16, Discussion Papers In: Economics And Business. Graduate School of Economics and Osaka School of International Public Policy (OSIPP), Osaka.
- Bernard A. and M. Vielle, 2008. GEMINI-E3, A General Equilibrium Model of International-National Interactions between Economy, Energy and the Environment. In: Computational Management Science 5 (3), 173-206.
- Beurskens, L.W.M., Hekkenberg, M. and P. Vethman, 2011. Renewable Energy Projections as published in the National Renewable Energy Action Plans of the European Member States Covering all 27 EU Member States with updates for 20 Member States. ECN-E--10-069. Retrieved from: <https://www.ecn.nl/projects/nreap/2010/data/>.
- BFE (Bundesamt für Energie), 2006. Schweizerische Gesamtenergiestatistik 2005. Technical report.
- BFE (Bundesamt für Energie), 2010. Gesamte Erzeugung und Abgabe elektrischer Energie in der Schweiz 2010, 10.04.2014. Retrieved 10/25/2013 from: http://www.bfe.admin.ch/themen/00526/00541/00542/00630/index.html?lang=de&dossier_id=00769
- BFE (Bundesamt für Energie), 2013. Perspektiven für die Grosswasserkraft in der Schweiz. Wirtschaftlichkeit von Projekten für grosse Laufwasser- und Speicherkraftwerke und mögliche Instrumente zur Förderung der Grosswasserkraft.
- BFE (Bundesamt für Energie), 2014. Stilllegungsfonds für Kernanlagen & Entsorgungsfonds für Kernkraftwerke - Faktenblatt Nr.1: Rechtsgrundlagen, Organisation und allgemeine Informationen. Retrieved from: http://www.bfe.admin.ch/entsorgungsfonds/index.html?lang=de&dossier_id=03842
- BMLFUW (Bundesministerium für Land- und Forstwirtschaft Umwelt und Wasserwirtschaft), 2009. Erneuerbare Energie 2020: Potenziale und Verwendung in Österreich. EnergieStrategie Österreich. Wien.
- BMWi (Bundesministerium für Wirtschaft und Energie), 2011. Zahlen und Fakten Energiedaten. Berlin.
- Böhringer, C. and T. Rutherford, 2008. Combining bottom-up and top-down. In: Energy Economics 30(2), 574–596.
- Böhringer, C. and T. Rutherford, 2009. Integrated assessment of energy policies: Decomposing top-down and bottom-up. In: Journal of Economic Dynamics and Control 33 (9), 1648–1661.

- Böhringer, C., Lange, A. and T. Rutherford, 2010. Optimal Emission Pricing in the Presence of International Spillovers: Decomposing Leakage and Terms-of-Trade Motives, NBER Working Paper 15899.
- Burniaux, J.-M. and T. P. Truong, 2002. GTAP-E: An Energy-Environmental Version of the GTAP Model. GTAP Technical Papers.
- Calvin K., Edmonds, J., Bond-Lamberty, B., Clarke, L., Kim, Son H., Kyle, P., Smith, Steven J., Thomson, A., and M. Wise, 2009. 2.6: Limiting climate change to 450 ppm CO₂ equivalent in the 21st century. In: *Energy Economics* 31 (Supplement 2), S107-S120.
- CDIAC (Carbon Dioxide Information Analysis Center), 2012. Preliminary 2009 & 2010 Global & National Estimates by Extrapolation, Carbon Dioxide Information Analysis Center, ORNL. Retrieved from: http://cdiac.ornl.gov/trends/emis/meth_reg.html.
- CEMSUISSE (Verband der Schweizerischen Zementindustrie), 2005: Kennzahlen. Retrieved from: www.cemsuisse.ch.
- CEMSUISSE (Verband der Schweizerischen Zementindustrie), 2011: Kennzahlen. Retrieved from: www.cemsuisse.ch.
- Chamorro, C. R., García-Cuesta, J. L., Mondéjar, M. E., and A. Pérez-Madrado, 2014. Enhanced geothermal systems in Europe: An estimation and comparison of the technical and sustainable potentials. In: *Energy*, 65(0), 250-263.
- Clarke, L., M. Wise, Edmonds, J., Placet, M., Kyle, P., Calvin, K., Kim, S. and S. Smith, 2008. CO₂ Emissions Mitigation and Technological Advance: An Updated Analysis of Advanced Technology Scenarios, PNNL, Prepared for US DOE.
- Connolly, D., Lund, H., Mathiesen, B. V. and M. Leahy, 2009. A review of computer tools for analysing the integration of renewable energy into energy systems. In: *Applied Energy* 87 (4), 1059-1082.
- Densing, M., Hirschberg, S. and H. Turton, 2014. Review of the Swiss Electricity Scenarios 2050. Paul Scherrer Institute, Villigen.
- DLR, 2013. Energy system model REMix. Retrieved 05/25/2013 from: http://www.dlr.de/Portaldata/41/Resources/dokumente/institut/system/Modellbeschreibungen/DLR_Energy_System_Model_REMix_short_description.pdf
- DLR, Fraunhofer IWES and IfnE Ingenieurbüro für neue Energien, 2012. Langfristszenarien und Strategien für den Ausbau der erneuerbaren Energien in Deutschland bei Berücksichtigung der Entwicklung in Europa und global. Schlussbericht.
- Drouet, L., Haurie, A., Labriet, M., Thalmann, Ph., Vielle, M. and L. Viguié, 2005. A Coupled Bottom-Up / Top-Down Model for GHG Abatement Scenarios in the Housing Sector of Switzerland. In: Loulou, R., Waub, J.-P. and G. Zaccour (eds.): *Energy and Environment*, 27–61.
- E-Control, 2014. Wasser- und wärmewirtschaftliche Kennzahlen. Retrieved 08/25/2014 from: http://www.e-control.at/de/statistik/strom/marktstatistik/kennzahlen_wasser_waerme
- EEA (European Environmental Agency), 2012. Annual European Union greenhouse gas inventory 1990–2010 and inventory report 2012, Technical Report 3/2012.
- ENTSO-E, 2013. European network of transmission system operators for electricity - Consumption data. Retrieved 01/31/2013 from: <https://www.entsoe.eu/data/data-portal/consumption/Pages/default.aspx>

- Ess, F., Haefke, L., Hobohm, J., Peter, F. and M. Wunsch, 2012. Bedeutung der internationalen Wasserkraft-Speicherung für die Energiewende (Weltenergieat-Deutschland, Trans.), Prognos, Berlin.
- ETSAP, 2008. A Comparison of the TIMES and MARKAL models. Retrieved from:
<http://www.etsap.org/TOOLS/TIMESvsMARKAL.pdf>
- European Commission, 1999. The AOP II Cost-effectiveness Study. Technical Report August, Brussels.
- European Commission, 2010. Energy infrastructure priorities for 2020 and beyond - A Blueprint for an integrated European energy network, Brussels.
- European Commission, 2011a. A Roadmap for moving to a competitive low carbon economy in 2050, Communication from the Commission to the European Parliament, the Council, the European Economic and Social Committee and the Committee of the Regions, COM(2011) 112 final, Brussels, 8.3.2011.
- European Commission, 2011b. The 2012 Ageing Report: Underlying Assumptions and Projection Methodologies, Brussels.
- European Commission, 2013. EU Energy, Transport and GHG Emissions, Trends to 2050 - Reference Scenario. Luxembourg.
- European Energy Exchange, 2014. Gesetzliche Veröffentlichungspflichten der Übertragungsnetzbetreiber. Retrieved 02/01/2014 from:
<http://www.transparency.eex.com/en/Statutory%20Publication%20Requirements%20of%20the%20Transmission%20System%20Operators/Power%20generation/Expected%20wind%20power%20generation>.
- EWI (Energiewirtschaftliches Institut), 2008. Dispatch and Investment Model for Electricity Markets in Europe: A brief overview.
- FASC, 2011. Federal Council decides to gradually phase out nuclear energy as part of its new energy strategy. In T. F. A. o. t. S. Confederation (Ed.). Bern.
- Fortes, P., Pereira, A. M. a., Pereira, R. M. and J. Seixas, 2014. Integrated technological-economic modeling platform for energy and climate policy analysis. In: Energy 43, 716-730.
- Frei, C. W., P.-A. Haldi, and G. Sarlos, 2003. Dynamic formulation of a top-down and bottom-up merging energy policy model. Energy Policy 31(10), 1017–1031.
- Gargiulo, M., 2013. Base level training on ETSAP tools. Paper presented at the Semi-annual ETSAP meeting, Paris.
- Gutschi Ch., Bachhiesel, U., Huber, Ch, Nischler, G., Jagl, A., Süßenbacher, W. and H. Stigler, 2009. ATLANTIS 1 - Simulationsmodell der europäischen Elektrizitätswirtschaft bis 2030. In: Elektrotechnik & Informationstechnik 126 (12), 438-448.
- Hertel, T. W., 1997. Global Trade Analysis: Modeling and Applications. Cambridge University Press.
- Hoffman, K. C. and D. W. Jorgenson, 1977. Economic and technological models for evaluation of energy policy. In: The Bell Journal of Economics 8 (2), 444–466.
- IEA (International Energy Agency), 2001. Competition in electricity markets, OECD, Paris.
- IEA (International Energy Agency), 2010. World Energy Outlook. Paris.
- IEA (International Energy Agency), 2011. CO₂ emissions from fuel combustion statistics, Paris.

- IRENA (International Renewable Energy Agency), 2012. Concentrating Solar Power. IRENA Working Paper, Volume 1: Power Sector (2/5).
- Johnsson, F. (ed.), 2011. Methods and Models used in the project Pathways to Sustainable European Energy Systems. Alliance for Global Sustainability. Retrieved from: http://www.energy-pathways.org/pdf/Metod_reportJan2011.pdf.
- JRC (Joint Research Centre, European Commission), 2013. Photovoltaic Geographical Information system - Interactive Maps. Retrieved from: <http://re.jrc.ec.europa.eu/pvgis/apps4/pvest.php>.
- Kannan, R. and H. Turton, 2011. Documentation on the Development of the Swiss TIMES Electricity Model (STEM-E) (L. f. E. S. Analysis, Trans.) PSI Bericht Nr. 11-03, Paul Scherrer Institute, Villigen.
- Kannan, R. and H. Turton, 2012. Cost of ad-hoc nuclear policy uncertainties in the evolution of the Swiss electricity system. *Energy Policy* 50(0), 391-406.
- Kanors Consultants, 2008. VEDA (VErsatile Data Analyst). Retrieved 08/07/2012 from: <http://www.kanors.com/Index.asp>.
- Kombaroglu, G. and R. Madlener, 2003. Energy and Climate Policy Analysis with the Hybrid Bottom-Up Computable General Equilibrium Model SCREEN: The Case of the Swiss CO₂ Act. *Annals of Operations Research* 121, 181–203.
- Körber, A. and Ph. Kaufmann, 2007. Serie Schweizer Wirtschaftsbranchen: Bauwirtschaft – zyklische Branche mit strukturellen Problemen. In: *Die Volkswirtschaft: das Magazin für Wirtschaftspolitik* 80 (2007), 36-40.
- Lako, P., 2010. Technical and economic features of renewable electricity technologies: ECN (Energy research Centre of the Netherlands).
- Lanati, F. and A. Gelmini, 2011. Scenario analysis for RES-E integration in Italy up to 2050. Paper presented at the EEM, 2011 8th International Conference on the European Energy Market.
- Lanz, B. and S. Rausch, 2011. General Equilibrium, Electricity Generation Technologies and the Cost of Carbon Abatement. In: *Energy Economics* 33 (5), 1035–1047.
- Laurent, D., Alain, H., Maryse, L., Philippe, T., Marc, V. and V. Laurent, 2005. A coupled bottom-up / top-down model for GHG abatement scenarios in the housing sector of Switzerland.
- Lohwasser, R. and R. Madlener, 2009. Simulation of the European Electricity Market and CCS Development with the HECTOR Model, E.ON Energy Research Center, Future Energy Consumer Needs and Behavior (FCN).
- Loulou, R., Goldstein G., Remne, U., Kanuida, A. and A. Lehtila, 2005. Documentation for the TIMES Model. Energy Technology Systems Analysis Programme.
- Maire, S., Vöhringer, F. and Ph. Thalmann, 2015. Linking electricity prices and costs in bottom-up top-down coupling under changing market environments, EPFL Working Paper Series in Environmental and Urban Economics No.1, submitted to *Energy Economics*.
- Manne, A. and C. Wene, 1992. MARKAL-MACRO: A linked model for energy- economic analysis. BNL-47161, Department of Applied Science, Brookhaven National Laboratory, Upton NY.
- Martinsen, T., 2011. Introducing technology learning for energy technologies in a national CGE model through soft links to global and national energy models. In: *Energy Policy* 39 (6), 3327–3336.
- Messner, S. and L. Schrattenholzer, 2000. MESSAGE-MACRO: linking an energy supply model with a macroeconomic module and solving it iteratively. *Energy* 25(3), 267– 282.

- Mohler, L. and D. Müller, 2012. Substitution Elasticities in Swiss Manufacturing. Bundesamt für Energie, Bern.
- Nathani, C., Sutter, D., van Nieuwkoop, R., Peter, M., Kraner, S., Holzhey, M., Rütter, H. and R. Zandonella, 2011. Energiebezogene Differenzierung der Schweizerischen Input-Output-Tabelle. Schlussbericht 23. Mai 2011.
- Ochoa, P. and A. van Ackere, 2009. Policy changes and the dynamics of capacity expansion in the Swiss electricity market. In: *Energy Policy* 37(5), 1983-1998.
- Odenberger, M. and T. Unger, 2011. The role of new interconnectors in European Energy Pathways: Pathways to Sustainable European Energy System.
- OECD iLibrary, IEA Electricity Information Statistics, 2013. Retrieved from: http://www.oecd-ilibrary.org/energy/data/iea-electricity-information-statistics_elect-data-en.
- ORCDECYS (Operations Research Decisions and Systems), 2011. Energy technology environment model: A tool for evaluation of energy & environment policy at a regional/urban level. Retrieved 05/20/2014 from: <http://apps.ordecys.com/etem>.
- Paltsev, S., 2004. Moving from Static to Dynamic General Equilibrium Economic Models (Notes for a beginner in MPSGE), June 1999 (Revision April 2004).
- Paltsev, S., Reilly, J., Jacoby, H. and J. Morris, 2009. The Cost of Climate Policy in the United States. In: *Energy Economics* 31, 235–243.
- Pattupara, R. and R. Kannan, 2014a. Alternative low carbon electricity pathways under a European nuclear phase-out - Achievement of Climate goals. Paper presented at the 53rd meeting of the EWGCFM & 2nd International Conference of RCEM, Chania, Greece.
- Pattupara, R. and R. Kannan, 2014b. Exploring uncertainties in CCS – De-carbonization of the power sector & country-wise opportunities. Paper presented at the 14th IAEE European Energy Conference, Rome, Italy.
- Paul Scherrer Institute, 2010. Sustainable Electricity: Wishful thinking or near term reality? *Energie-Spiegel* No. 20, 2012. Retrieved from: http://www.psi.ch/info/MediaBoard/Energiespiegel_Nr20_072010_d.pdf.
- Paul Scherrer Institute, 2012. The new Swiss energy policy: Where will the electricity come from? *Energie-Spiegel* Nr. 21. 2012. Retrieved from: http://www.psi.ch/info/MediaBoard/Energiespiegel_21_e.pdf.
- Pfenninger, S., Hawkes, A., and J. Keirstead, 2014. Energy systems modeling for twenty-first century energy challenges. In: *Renewable and Sustainable Energy Reviews* 33(0), 74-86.
- Prognos, 2010. Appraisal of Power Plant Projects. Retrieved from: http://www.prognos.com/fileadmin/pdf/English/PDF/Power_plant_fleet.pdf
- Prognos, 2012. Die Energieperspektiven für die Schweiz bis 2050. Energienachfrage und Elektrizitätsangebot in der Schweiz 2000-2050. Ergebnisse der Modellrechnungen für das Energiesystem, commissioned by Eidgenössisches Departement für Umwelt, Verkehr, Energie und Kommunikation, Bundesamt für Energie, Basel.
- Ragwitz, M., Schade, W., Breitschopf, B., Walz, R., Helfrich, N., Resch, G., Panzer, C., Faber, T. and R. Haas, 2009. EmployRES. The impact of renewable energy policy on economic growth and employment in the European Union. Technical Report April.
- Reiter, U., 2010. Assessment of the European Energy Conversion Sector under Climate Change Scenarios. ETH Zürich: Ph.D. Thesis, No. 18840.

- Resch, G., Ragwitz, M. and I. Konstantinaviciute, 2006. Potentials and cost for renewable electricity in Europe.
- Réseau de transport d'électricité, 2012. Wind power generation forecast. 2012. Retrieved from: http://clients.rte-rance.com/lang/an/visiteurs/vie/previsions_eoliennes.jsp.
- Riekkola, A. K., Berg, C., Ahlgren, E. O. and P. Söderholm, 2013. Challenges in Soft-Linking: The Case of EMEC and TIMES-Sweden, National Institute of Economic Research, Working Paper No. 133.
- Rutherford, T., 1998. Economic Equilibrium Modeling with GAMS: An Introduction to GAMS/MCP and GAMS/MPSGE.
- Sceia, A., Vielle, M., Weidmann, N. and J.-C. Altamirano-Cabrera, 2012. Climate Assessment of acceptable Swiss post-2012 climate policies. *Swiss Journal of Economics and Statistics*, 347–380.
- Schäfer, A. and H. D. Jacoby, 2005. Technology detail in a multisector CGE model: transport under climate policy. In: *Energy Economics* 27 (1), 1–24.
- Schlecht, I. and Weigt, H., 2014. Swissmod: A model of the Swiss electricity market. In: FoNEW (Ed.), Discussion Paper 2014/01. Basel: Universität Basel (WWZ).
- Schröder, A., Kunz, F., Meiss, J., Mendelevitich, R. and C. von Hirschhausen, 2013. Current and Prospective Costs of Electricity Generation until 2050, DIW Berlin, German Institute for Economic Research. Berlin.
- Simoës, S., Njis, W., Ruiz, P., Sgobbi, A., Radu, D., Bolat, P. and S. Peteves, 2013. The JRC-EU-TIMES model - Assessing the long-term role of the SET Plan Energy technologies. JRCf: Publications Office of the European Union.
- Stone, R., 1954. Linear Expenditure Systems and Demand Analysis: An Application to the Pattern of British Demand. In: *Economic Journal* 64, 511-527.
- Sugandha, D. T., Yuan, M., Bernstein, P., Montgomery, W. D. and A. Smith, 2009. A top-down bottom-up modeling approach to climate change policy analysis. *Energy Economics* 31, S223–S234.
- Swiss Grid, 2008. Informationsveranstaltung Bilanzgruppenmanagement. Retrieved from: https://www.swissgrid.ch/swissgrid/en/home/experts/topics/bgm/bg_documents.html.
- TERNA, 2014. Transparency report. Retrieved 02/01/2014 from: http://www.terna.it/default/home_en/electric_system/transparency_report_en/generation.aspx.
- Tyndall Centre for Climate Change Research, 2010. ADAM - Adaptation and Mitigation Strategies: Supporting European climate policy. Retrieved from: http://climate-adapt.eea.europa.eu/projects1?ace_project_id=1.
- UNFCCC, 2012a. Norway Inventory 2010, Submission 2012 v2.1: Retrieved from: http://unfccc.int/files/national_reports/annex_i_ghg_inventories/national_inventories_submissions/application/zip/nor-2012-crf-25may.zip.
- UNFCCC, 2012b. Croatia Inventory 2010, Submission 2012 v2.1: Retrieved from: http://unfccc.int/files/national_reports/annex_i_ghg_inventories/national_inventories_submissions/application/zip/hrv-2012-crf-25may.zip.
- United Nations, Department of Economic and Social Affairs, Population Division, 2011. World Population Prospects: The 2010 Revision.

- UVEK (Eidgenössisches Departement für Umwelt, Verkehr, Energie und Kommunikation), 2011: Doris Leuthard: "Sicherheit hat oberste Priorität". Retrieved from: <http://www.uvek.admin.ch/dokumentation/00474/00492/index.html?lang=de&msg-id=38101>.
- Vöhringer, F., 2012. Linking the Swiss Emissions Trading System with the EU ETS: Economic Effects of Regulatory Design Alternatives. In: *Swiss Journal of Economics and Statistics* 148 (2), 167–196.
- Vöhringer, F., Mathys, N. and J.-M. Grether, 2013. Trade and Climate Policies: Do Emissions from International Transport Matter? In: *The World Economy* 36 (3), 280–302.
- von Weizsäcker, C. C., and J. Perner, 2001. An integrated simulation model for European electricity and natural gas supply. In: *Electrical Engineering* 83 (5-6), 265-270.
- Voogt, M. H., 2001. Renewable Energy burden sharing - REBUS: manual for the REBUS model. ECN-i-01-006, Petten.
- Weidmann, N., Kannan, R. and H. Turton, 2012. Swiss Climate Change and Nuclear Policy: A Comparative Analysis Using an Energy System Approach and a Sectoral Electricity Model. In: *The Swiss Journal of Economics and Statistics* 148(2), 275-316.
- Welsch, M., Deane, P., Howells, M., Ó Gallachóir, B., Rogan, F., Bazilian, M. and H.-H. Rogner, 2014. Incorporating flexibility requirements into long-term energy system models – A case study on high levels of renewable electricity penetration in Ireland. In: *Applied Energy* 135(0), 600-615.
- Wene, C.-O., 1996. Energy-economy analysis: linking the macroeconomic and systems engineering approaches. In: *Energy* 21 (9), 809–824.
- Wing, I. S., 2006. The synthesis of bottom-up and top-down approaches to climate policy modeling: Electric power technologies and the cost of limiting US CO₂ emissions. In: *Energy Policy* 34(18), 3847–3869.
- World Nuclear Association, 2014. Nuclear Power in Germany. Retrieved 03/15/2014 from: <http://www.world-nuclear.org/info/Country-Profiles/Countries-G-N/Germany/>

Appendix A – Country specific details

1 Austria

1.1 Existing technologies

Table A 1: Existing technology & model calibration (2010)

Technology description	Stock capacity (GW)	Production (PJ)	Eff (%)	AF (%)	Peak contribution
Hydro (river)	5.7	109	80%	63%	90%
Hydro (dam)	4.3	29	80%	25%	90%
Pump hydro	3	12	70%	17%	100%
Solar: PV	0.1	0.3	100%	11%	0%
Wind: onshore	1	7	100%	24%	0%
Geothermal	0.001	0.004	100%	23%	50%
Biogas	0.4	3	36%	26%	30%
Wood/biomass	0.8	13	21%	47%	90%
Waste incinerator	0.6	3	16%	28%	30%
Coal: SCPC	1.6	24	41%	63%	90%
Gas: GTCC base load	2.4	27	58%	80%	100%
Gas: GTCC flexible load	1.6	24	39%	48%	100%
Oil engine	0.3	5	26%	77%	100%

Source: BMLFUW 2009; ENTSO-E; OECD iLibrary.

1.2 Hydro power

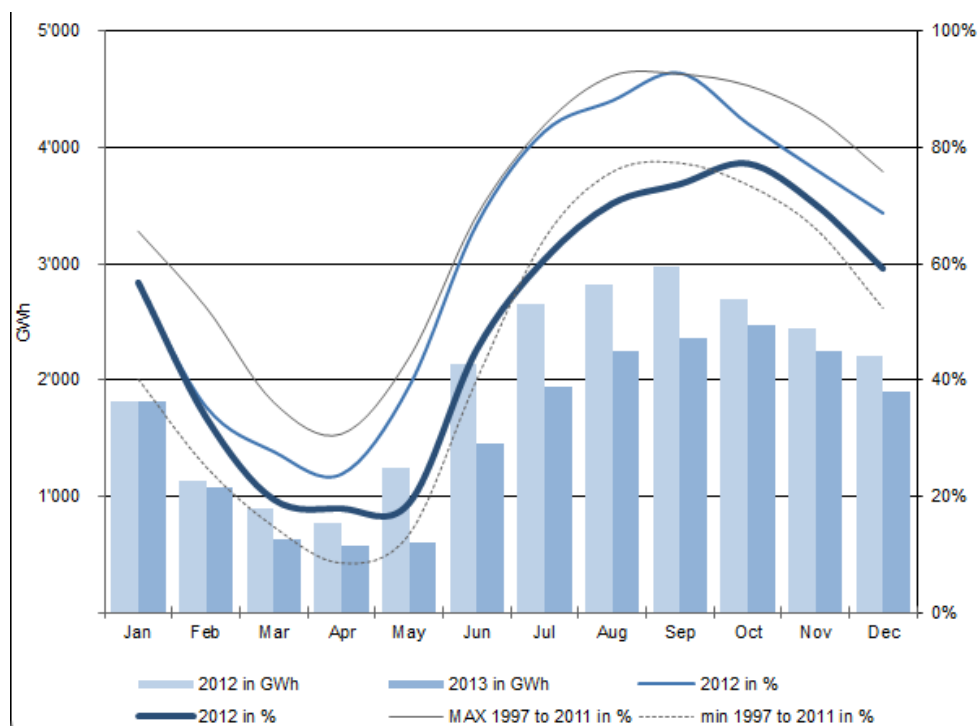

Source: E-control 2014.

Figure A 1: Dam hydro plants capacity factors - Austria

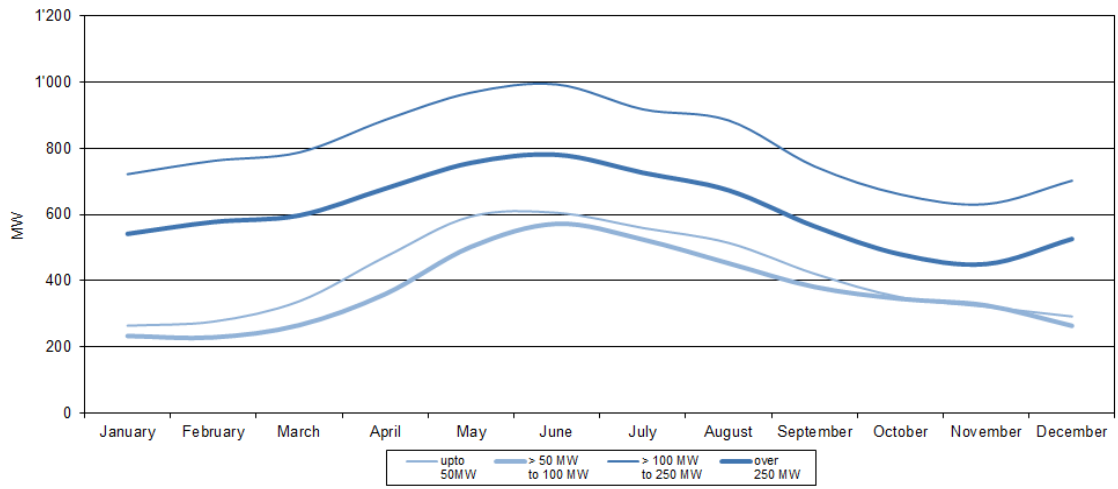

Source: E-control 2014.

Figure A 2: River hydro production (2012) - Austria

1.3 Solar PV

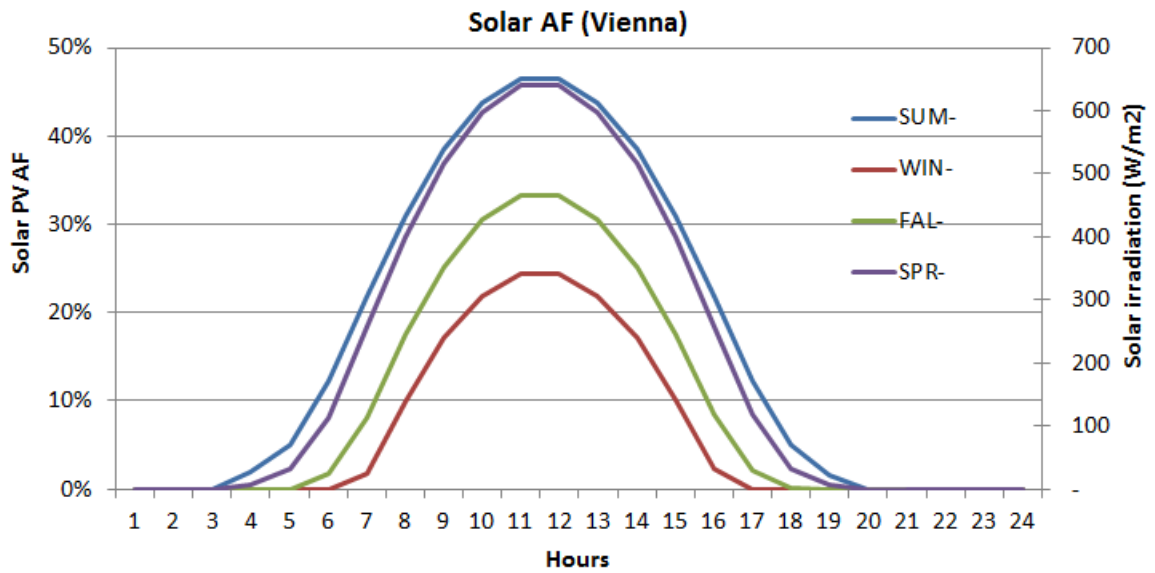

Source: JRC 2013.

Figure A 3: Solar Availability factor (Vienna)

1.4 Wind

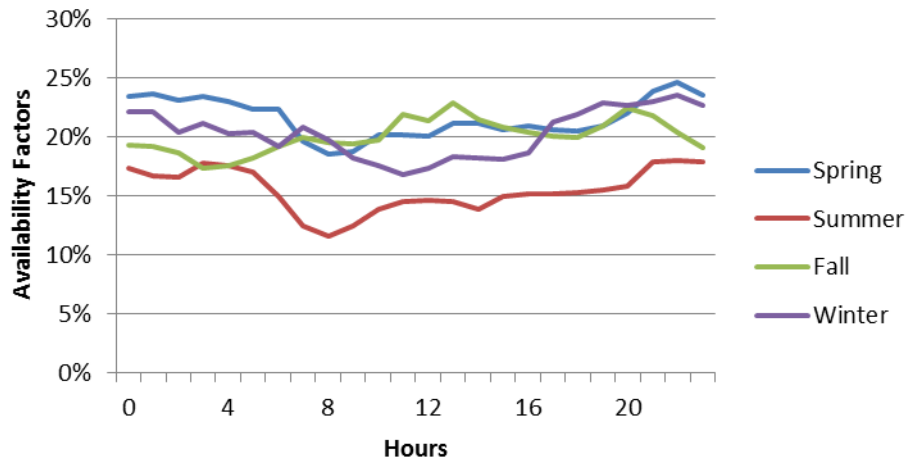

Source: Austrian Power Grid 2014.

Figure A 4: Wind (onshore) availability factor - Austria

1.5 Electricity demand load curve

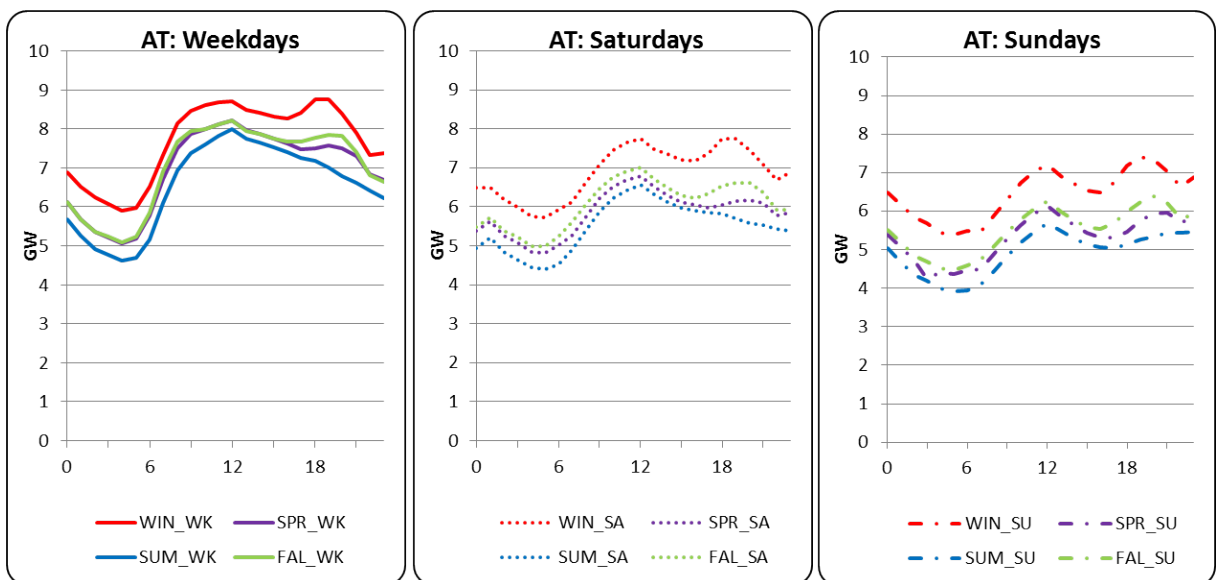

Source: ENTSO-E.

Figure A 5: Electricity load profiles (2010) - Austria

1.6 Electricity Import / Export

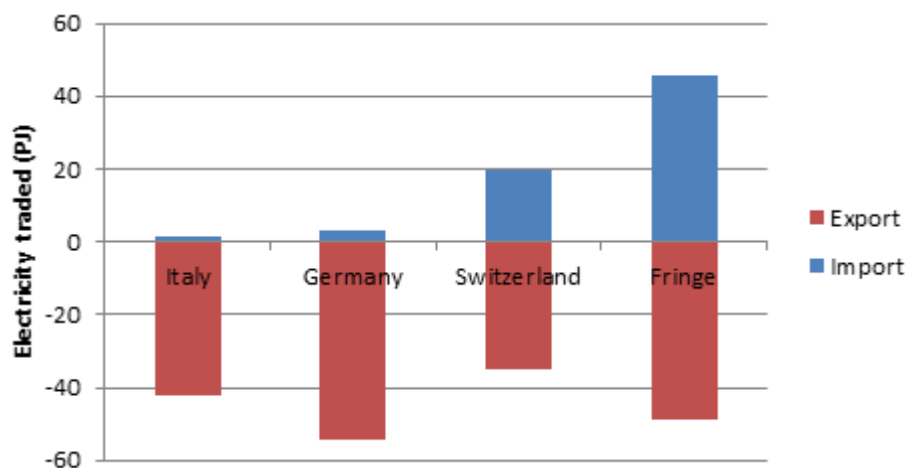

Source: ENTSO-E, OECD iLibrary.

Figure A 6: Electricity imports & exports 2010 - Austria

2 Germany

2.1 Existing technology

Table A 2: Existing technology & model calibration (2010) - Germany

Technology description	Stock capacity (GW)	Production (PJ)	Eff (%)	AF (%)	Peak contribution
Hydro (river)	5.1	72	80%	45%	90%
Hydro (dam)	0.6	3	80%	17%	90%
Pump hydro	6.8	23	74%	19%	100%
Solar: PV	21.3	42	100%	12%	0%
Wind: onshore	27.2	136	100%	21%	0%
Geothermal	0.008	0.1	100%	23%	50%
Biogas	4.8	106	53%	80%	30%
Wood/biomass	6.2	73	40%	46%	90%
Waste incinerator	1.7	17	19%	39%	30%
Nuclear	23.5	506	33%	85%	100%
Lignite: SCPC	22.7	525	38%	83%	90%
Coal: SCPC	30.2	421	41%	55%	90%
Gas: GTCC base load	7.2	186	58%	82%	100%
Gas: GTCC flexible load	16.6	124	42%	44%	100%
Oil engine	5.9	30	43%	24%	100%

Source: BWE 2011; ENTSO-E; OECD iLibrary.

2.2 Solar PV

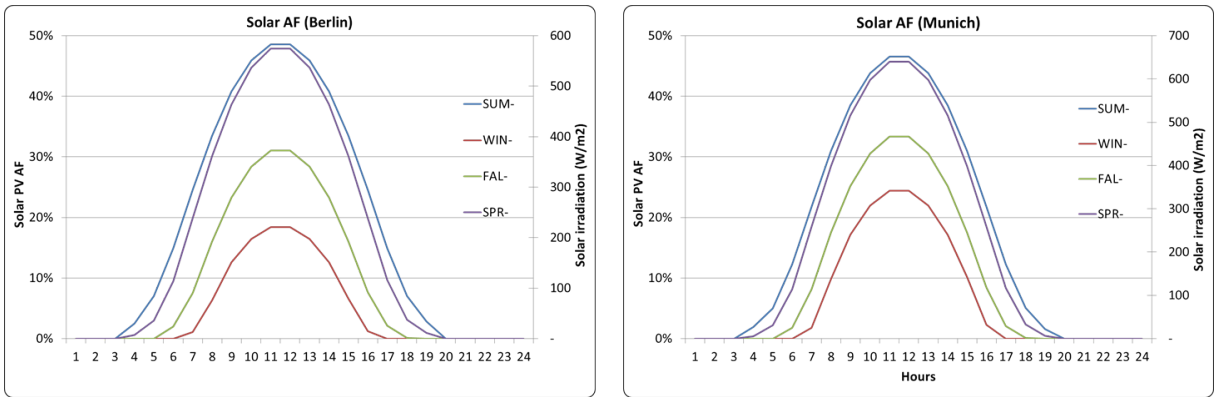

Source: JRC 2013.

Figure A 7: Solar availability factors (Berlin & Munich)

2.3 Wind

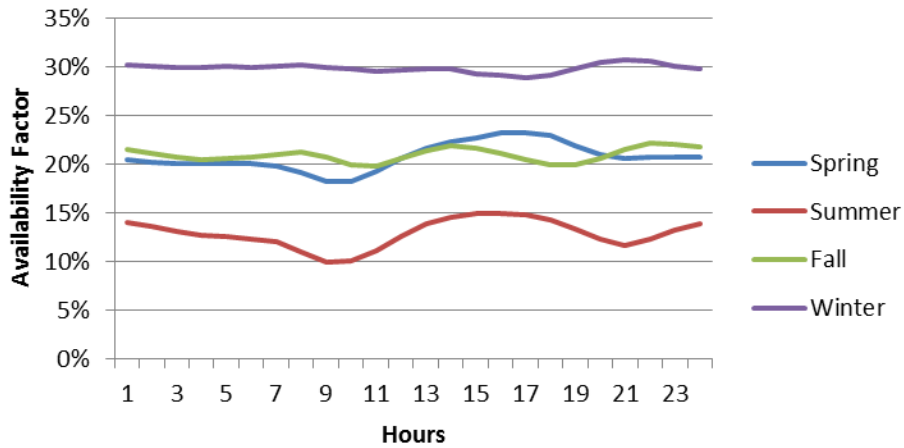

Source: European Energy Exchange, Transparency reports 2014

Figure A 8: Wind availability factor (onshore) - Germany

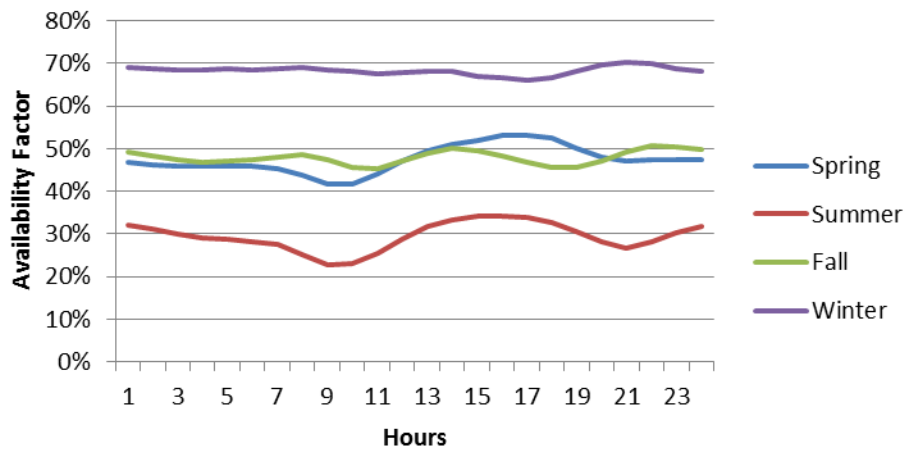

Source: European Energy Exchange, Transparency reports, 2014.

Figure A 9: Wind availability factor (offshore) - Germany

2.4 Electricity demand curves

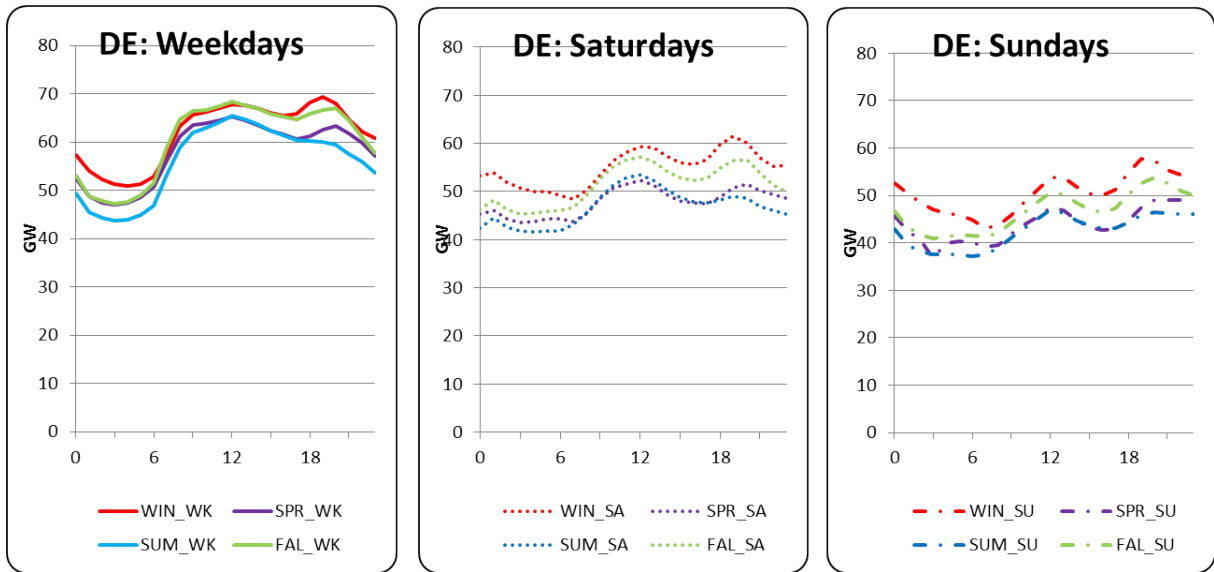

Source: ENTSO-E.

Figure A 10: Electricity load profiles (2010) - Germany

2.5 Electricity import/export

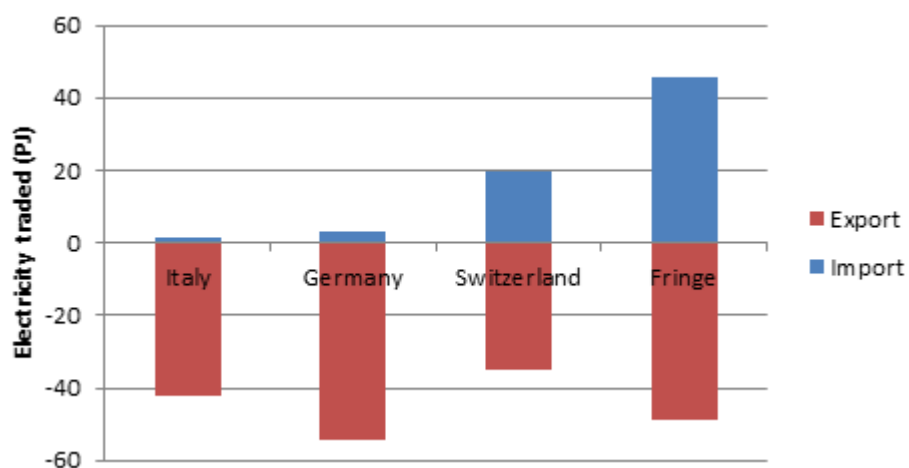

Source: ENTSO-E, OECD iLibrary.

Figure A 11: Electricity imports & exports 2010 - Germany

3 France

3.1 Existing technology

Table A 3: Existing technology & model calibration (2010) - France

Technology description	Stock capacity (GW)	Production (PJ)	Eff (%)	AF (%)	Peak contribution
Hydro (river)	8.5	122	80%	45%	90%
Hydro (dam)	13.9	103	80%	24%	100%
Pump hydro	1.8	20	71%	36%	100%
Solar: PV	1.0	2	100%	15%	0%
Wind: onshore	5.9	36	100%	22%	0%
Tide	0.24	2	100%	27%	0%
Biogas	0.62	4	31%	20%	30%
Wood/biomass	1.2	6	40%	15%	30%
Waste incinerator	2.4	15	20%	20%	30%
Nuclear	63.1	1543	35%	82%	100%
Coal: SCPC	3.5	95	40%	85%	90%
Gas: GTCC flexible load	9.5	86	31%	40%	100%
Oil engine	10.4	21	21%	40%	100%

Source: RTE, 2010; ENTSO-E; OECD iLibrary.

3.2 Solar PV

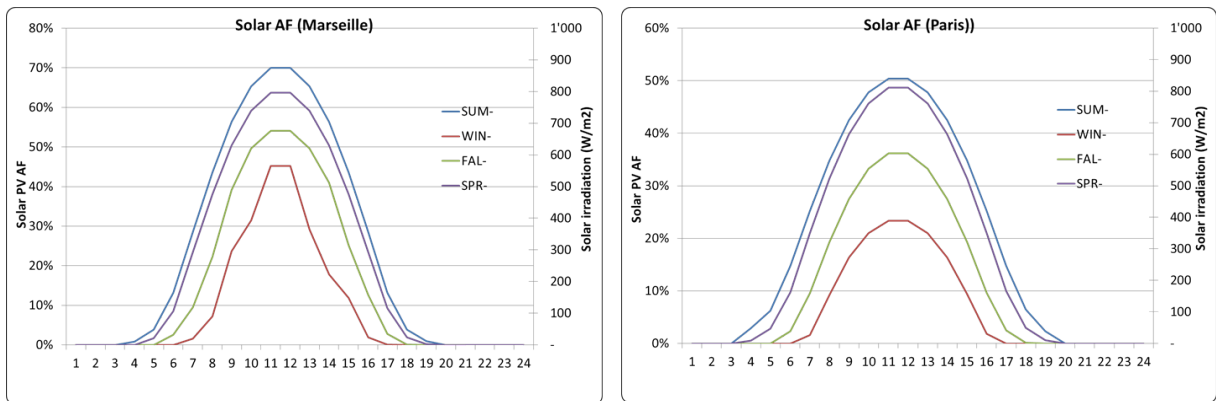

Source: JRC, 2013.

Figure A 12: Solar availability factors (Marseille & Paris)

3.3 Wind

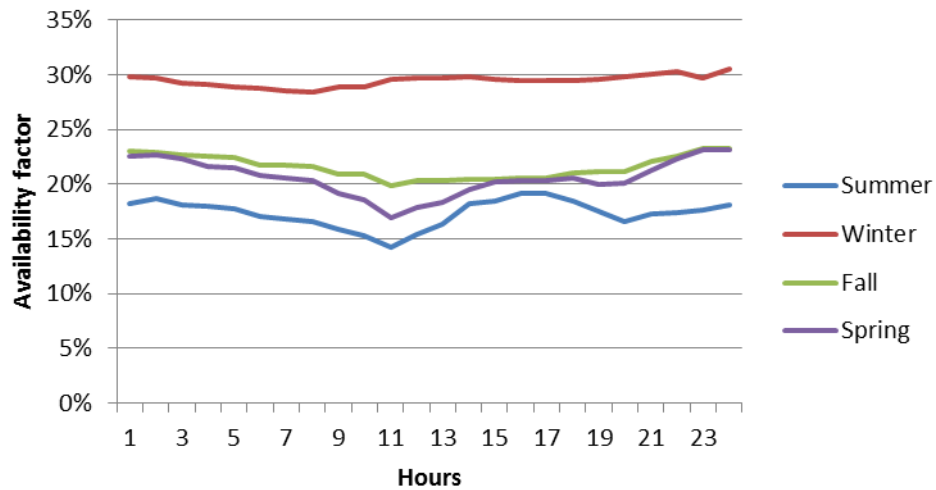

Source: Réseau de transport d'électricité 2012.

Figure A 13: Wind availability factor (onshore) - France

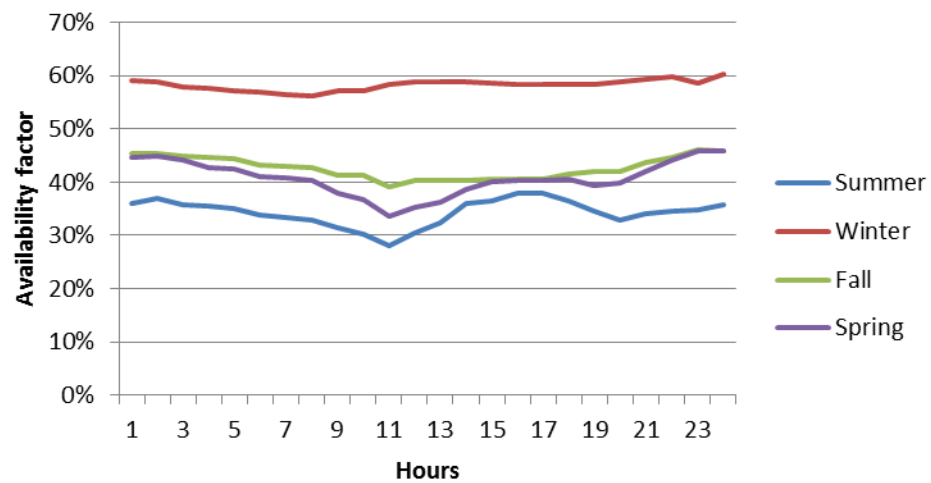

Source: Réseau de transport d'électricité 2012.

Figure A 14: Wind availability factor (offshore) - France

3.4 Electricity demand curves

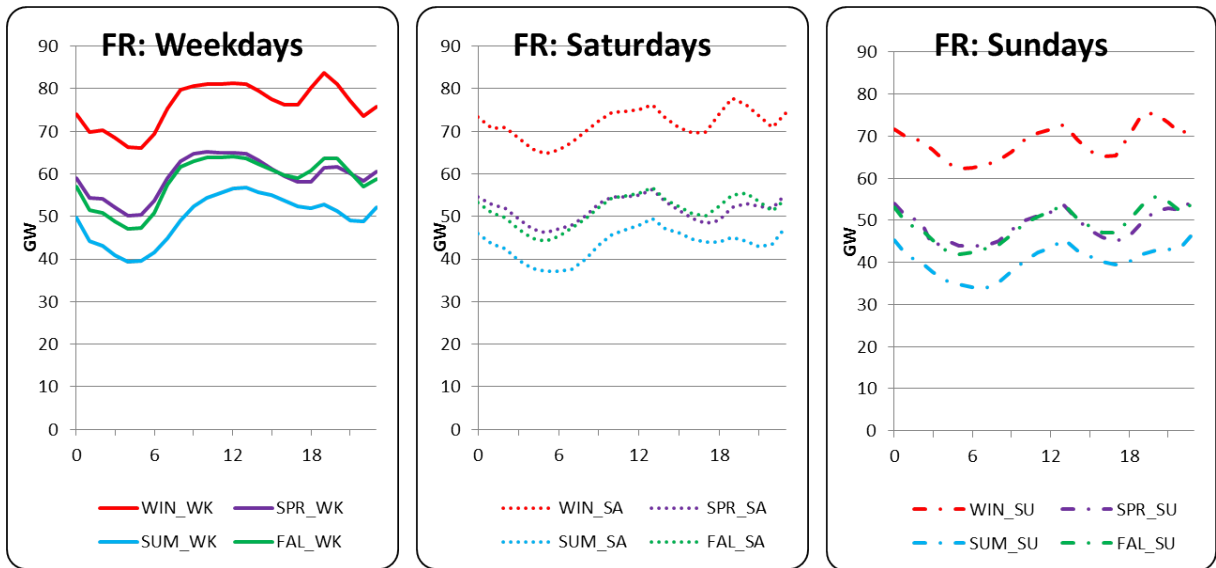

Source: ENTSO-E.

Figure A 15: Electricity load profiles (2010) - France

3.5 Electricity import/export

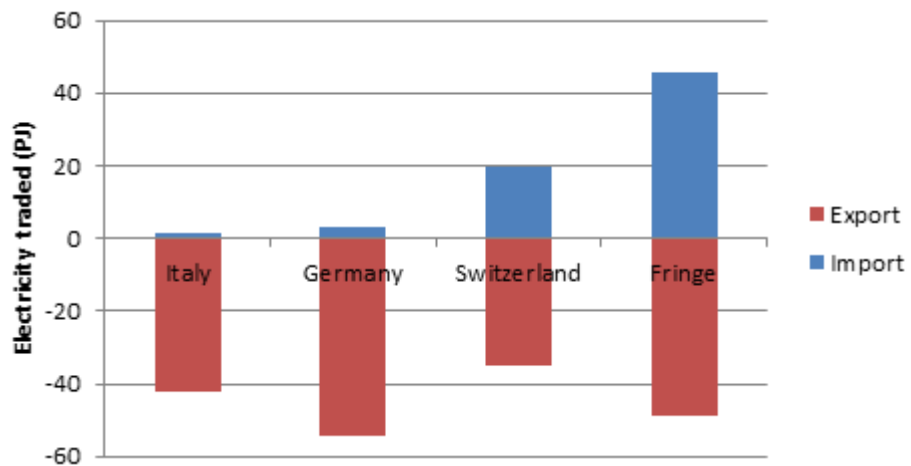

Source: ENTSO-E, OECD iLibrary.

Figure A 16: Electricity imports & exports 2010

4 Italy

4.1 Existing technology

Table A 4: Existing technology & model calibration (2010) - Italy

Technology description	Stock capacity (GW)	Production (PJ)	Eff (%)	AF (%)	Peak contribution
Hydro (river)	9.8	136	80%	45%	90%
Hydro (dam)	4.4	48	80%	35%	90%
Pump hydro	7.7	12	74%	12%	100%
Solar: PV	3.5	7	100%	19%	0%
Wind: onshore	5.8	33	100%	25%	0%
Geothermal	0.8	19	100%	90%	50%
Biogas	1.1	19	41%	53%	30%
Wood/biomass	1.2	16	15%	46%	90%
Coal: SCPC	11.2	143	38%	54%	90%
Gas: GTCC base load	22.5	333	51%	74%	100%
Gas: GTCC flexible load	14.9	220	42%	59%	100%
Oil engine	23.1	124	35%	64%	100%

Source: TERNA 2014; ENTSO-E; OECD iLibrary.

4.2 Solar PV

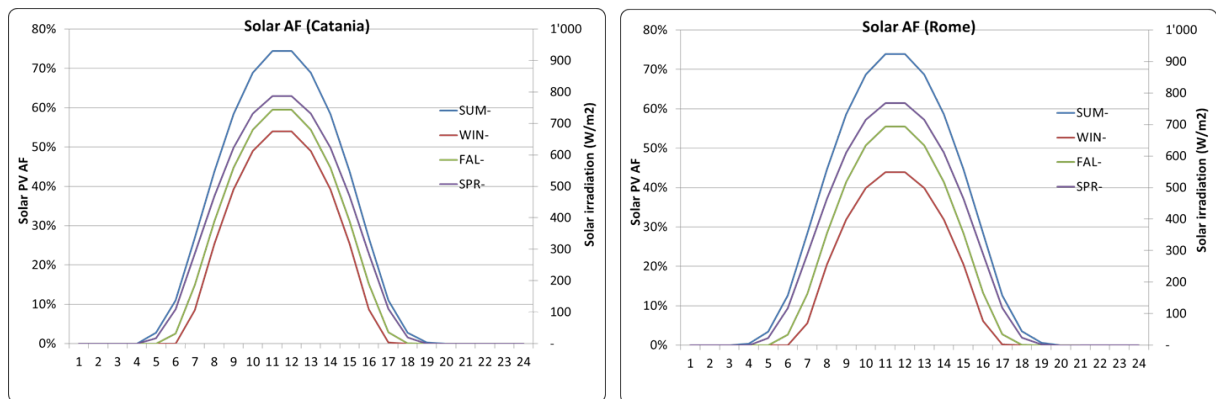

Source: JRC, 2013.

Figure A 17: Solar availability factors (Catania & Rome)

4.3 Wind

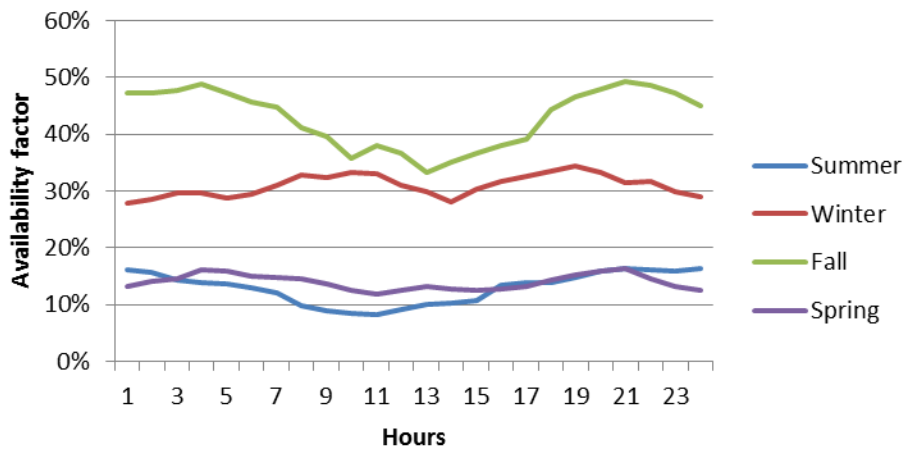

Source: TERNA 2014.

Figure A 18: Wind availability factor (onshore) - Italy

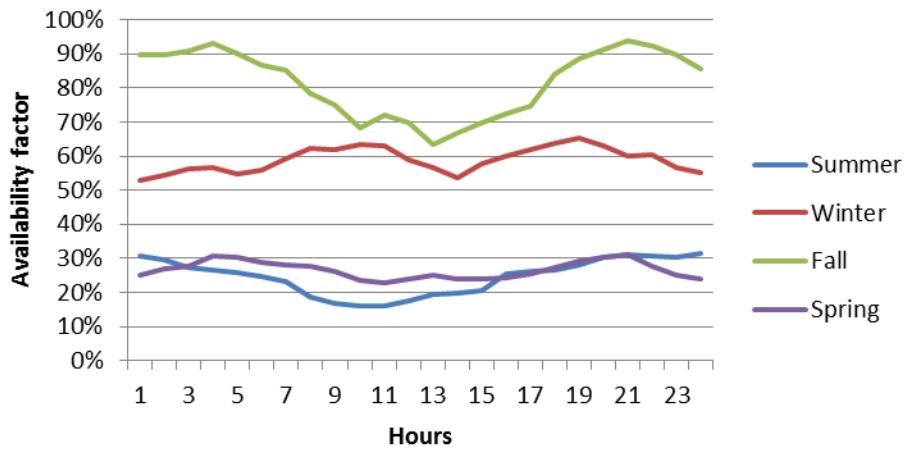

Source: TERNA 2014.

Figure A 19: Wind availability factor (offshore) - Italy

4.4 Electricity demand curves

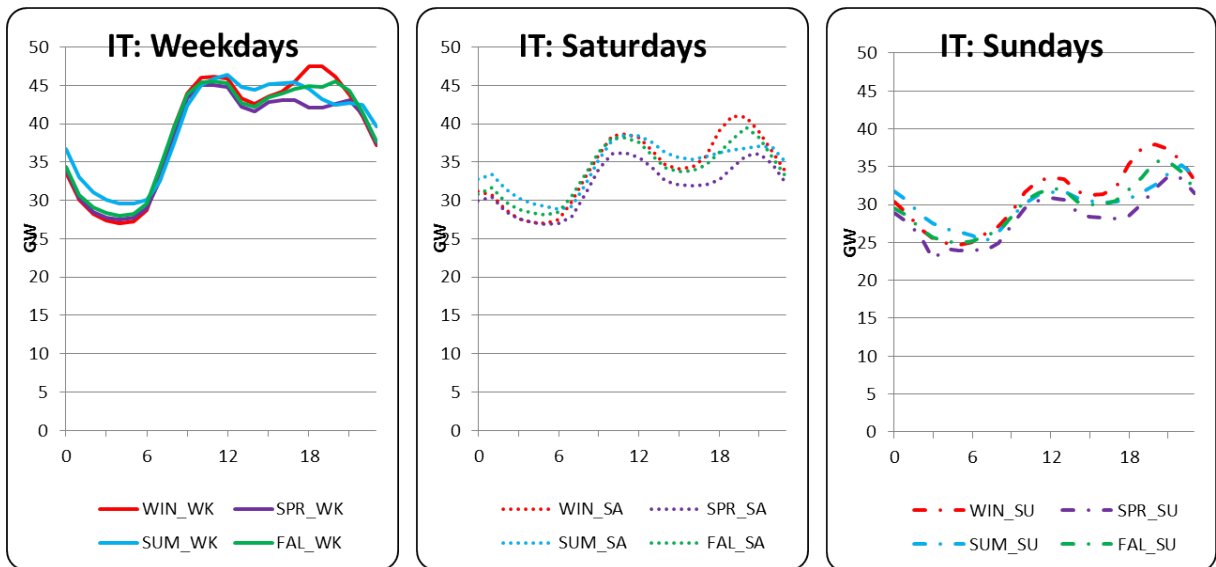

Source: ENTSO-E.

Figure A 20: Electricity load profiles (2010) - Italy

4.5 Electricity import/export

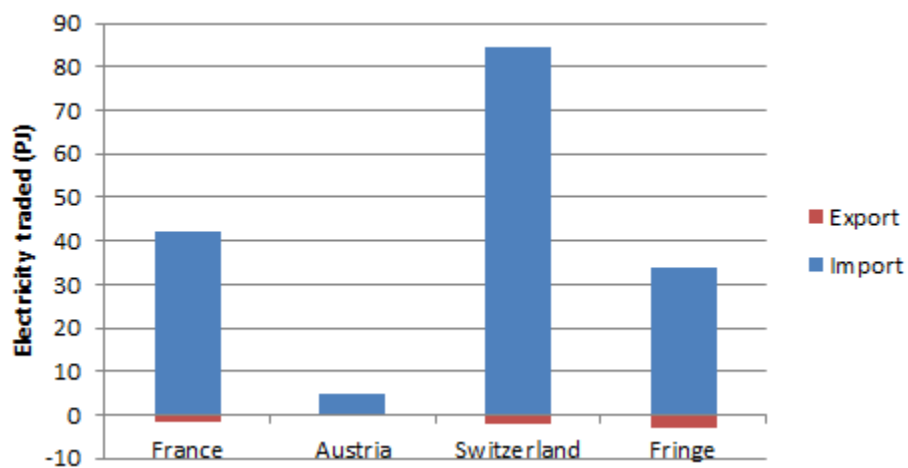

Source: ENTSO-E; OECD iLibrary.

Figure A 21: Electricity imports & exports 2010 - Italy

5 Switzerland

5.1 Existing technologies

Table A 5: Existing technology & model calibration (2010) - Switzerland

Technology description	Stock capacity (GW)	Production (PJ)	Eff (%)	AF (%)	Peak contribution
Hydro (river)	3.7	58	80%	55%	90%
Hydro (dam)	8.1	70	80%	28%	90%
Pump hydro	1.4	7	80%	19%	100%
Solar: PV	0.1	0.3	100%	11%	0%
Wind: onshore	0.04	0.13	100%	14%	0%
Biogas	0.3	0.01	32%	57%	30%
Wood/biomass	0.03	0.5	13%	38%	90%
Waste incinerator	0.3	5.5	40%	57%	30%
Gas: GTCC base load	0.6	7.2	35%	57%	100%
Nuclear (Mühleberg)	0.365	9.5	30%	96%	90%
Nuclear (Beznau - 1)	0.365	10.2	30%	96%	90%
Nuclear (Beznau - 2)	0.373	10.7	30%	91%	90%
Nuclear (Gösgen)	0.970	28.7	30%	94%	90%
Nuclear (Leibstadt)	1.2	31.6	30%	90%	90%
Oil engine	0.1	0.06	18%	38%	100%

Source: BfE 2010; ENTSO-E; OECD iLibrary; Kannan/Turton 2011.

5.2 Hydro power

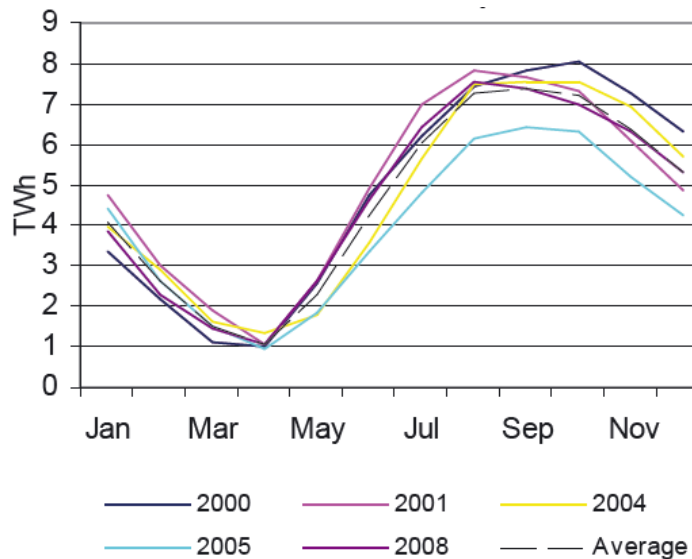

Source: Kannan/Turton 2011.

Figure A 22: Dam hydro reservoir availability - Switzerland

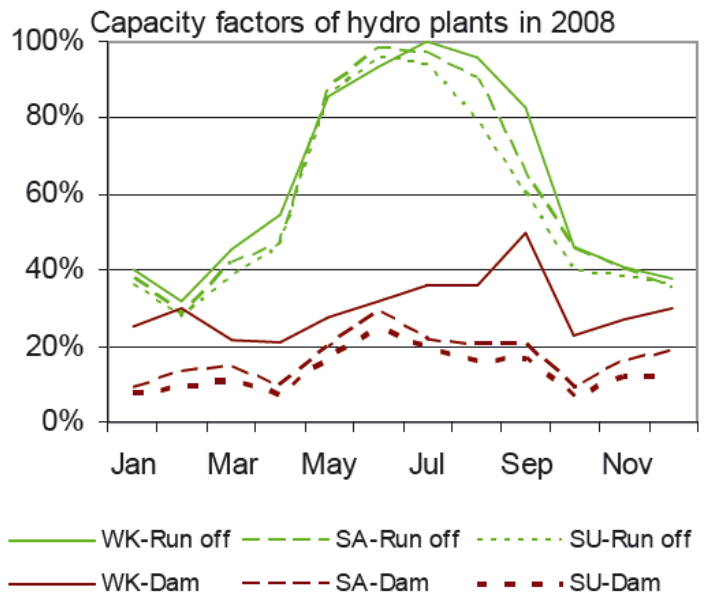
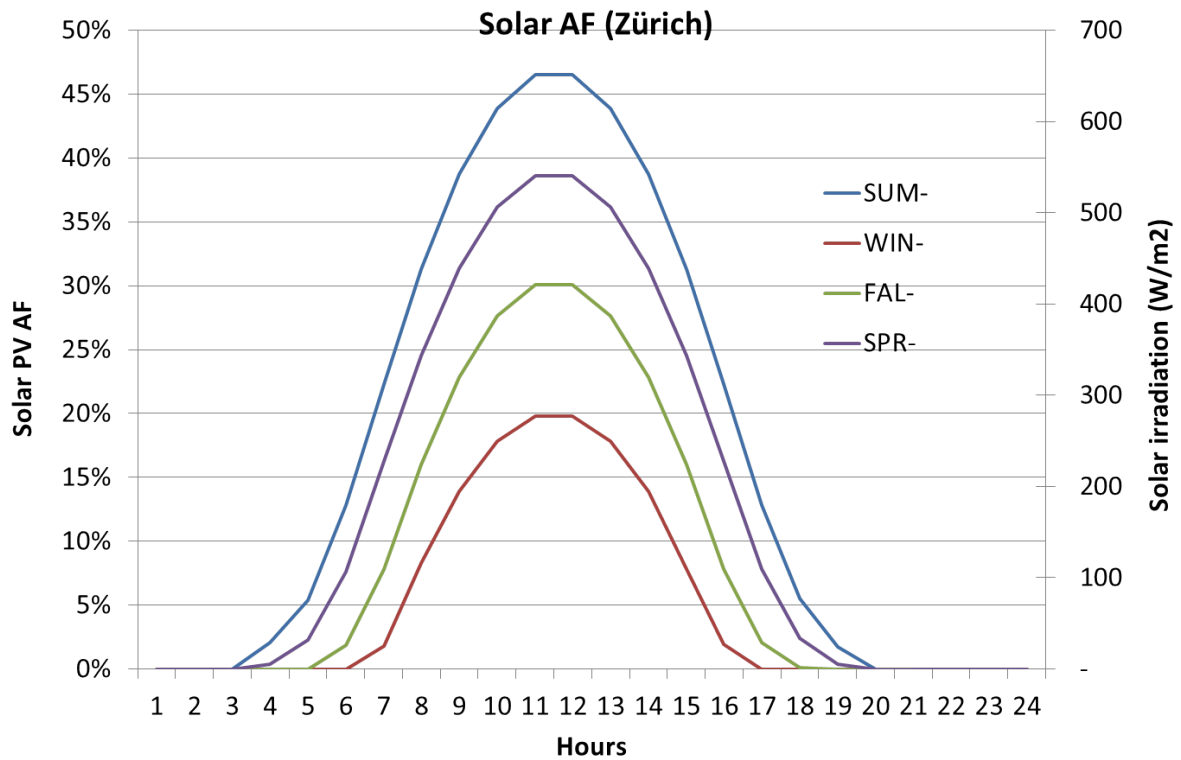

Figure A 23: Capacity factors of hydro plants - Switzerland

5.3 Solar PV



Source: JRC 2013.

Figure A 24: Solar availability factors (Zürich)

5.4 Wind

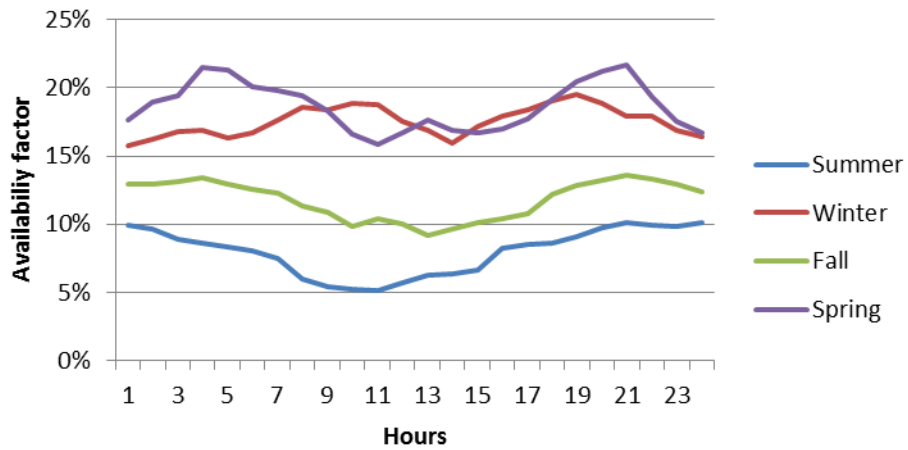

Source: Kannan/Turton 2011.

Figure A 25: Wind availability factor (onshore) - Switzerland

5.5 Load curve

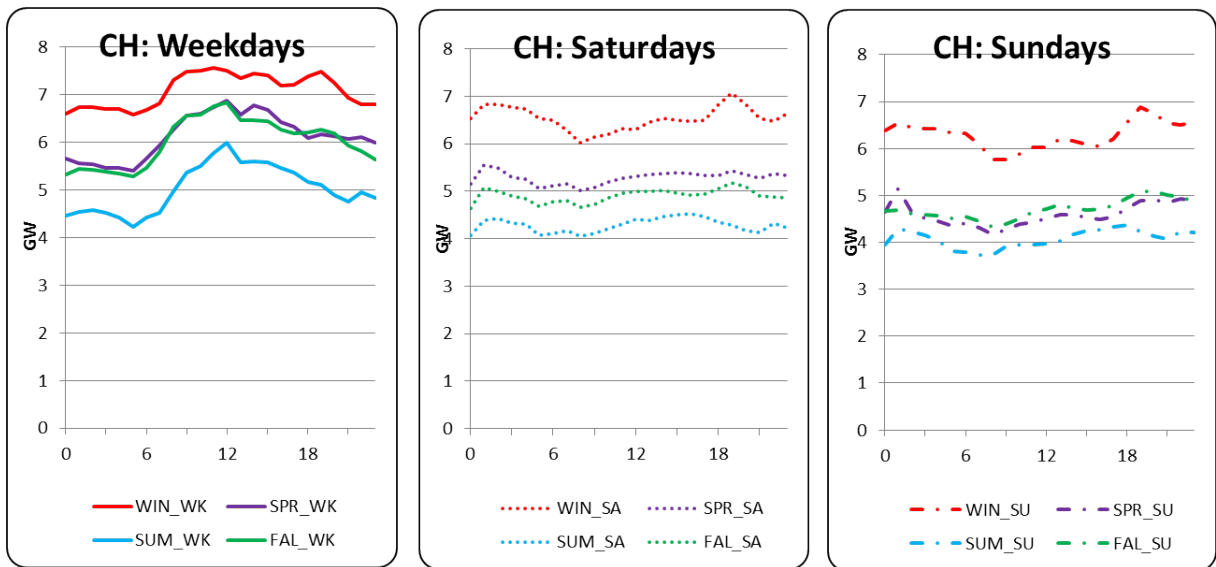

Source: ENTSO-E.

Figure A 26: Electricity load profiles (2010) - Switzerland

5.6 Electricity import / export

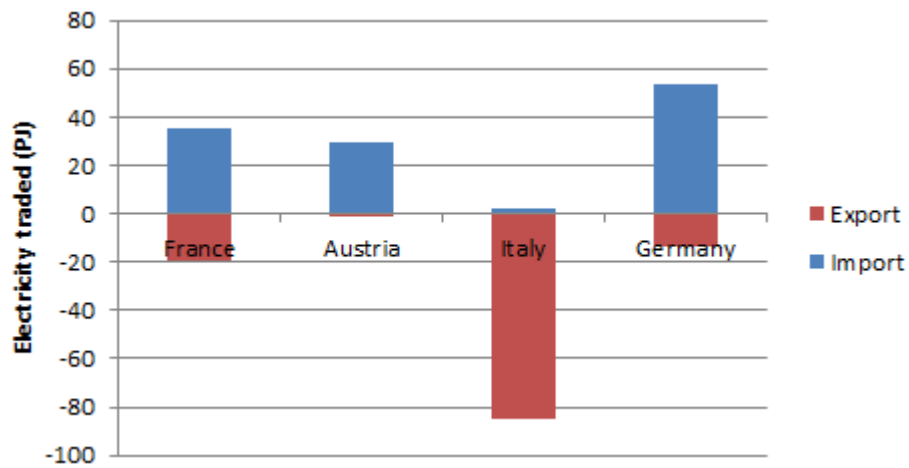

Source: ENTSO-E; OECD iLibrary.

Figure A 27: Electricity imports & exports 2010 - Switzerland

5.7 Net electricity import restrictions for the NoGas scenario

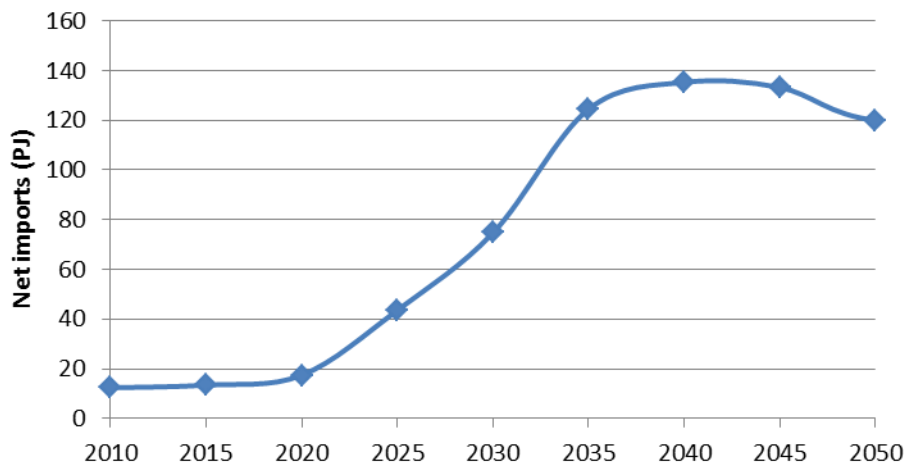

Figure A 28: Net electricity import allowance for Switzerland (NoGas)

Appendix B – CROSSTEM results

1 Country-specific results

1.1 France

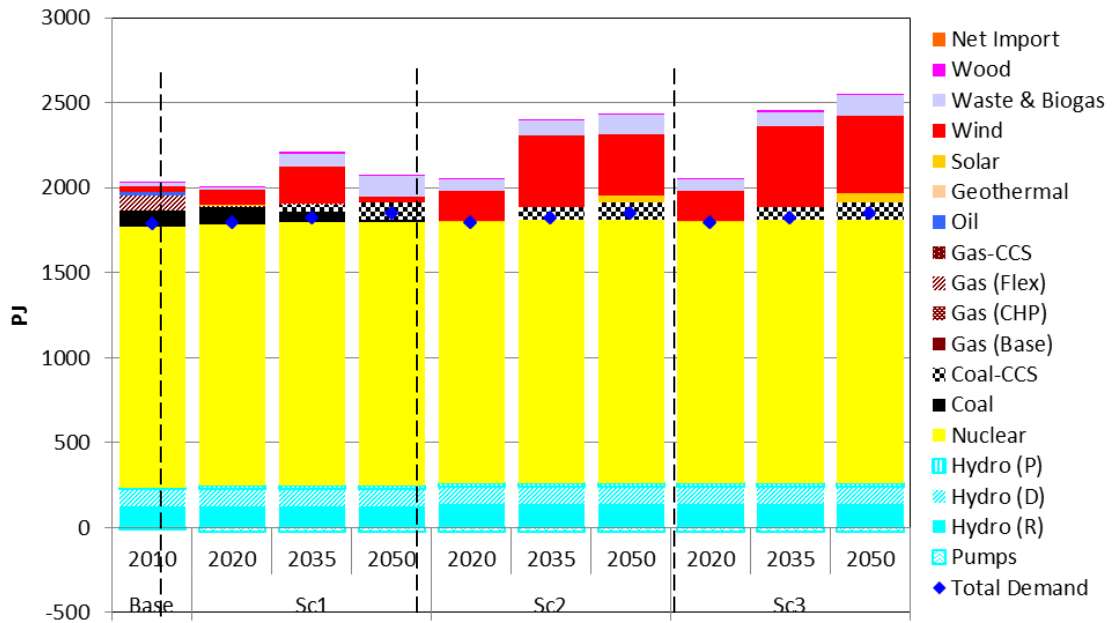

Figure B 1: Electricity generation mix - France

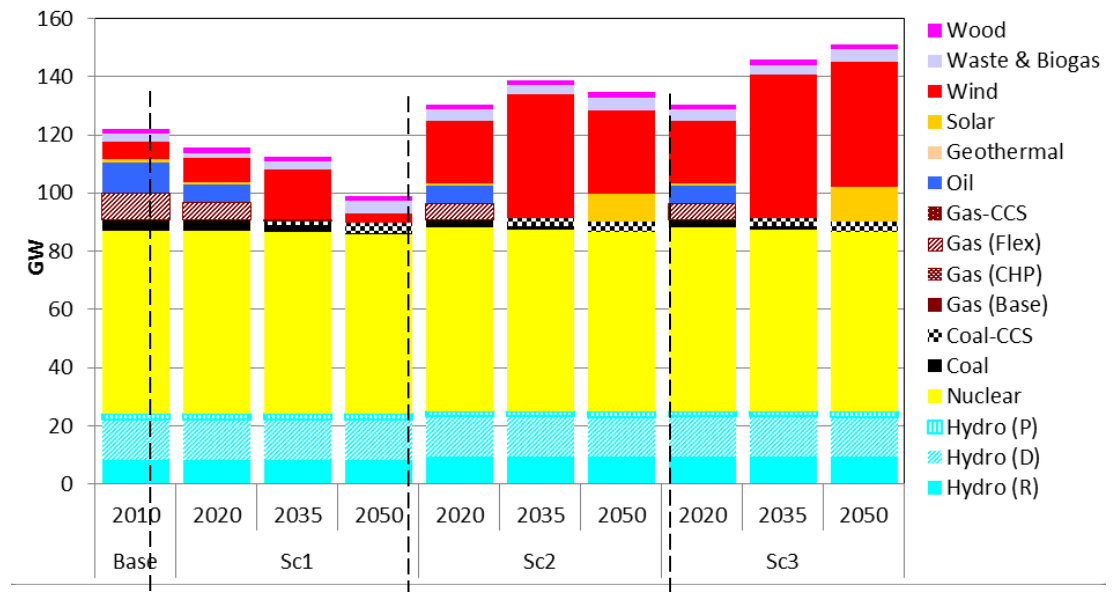

Figure B 2: Installed capacity - France

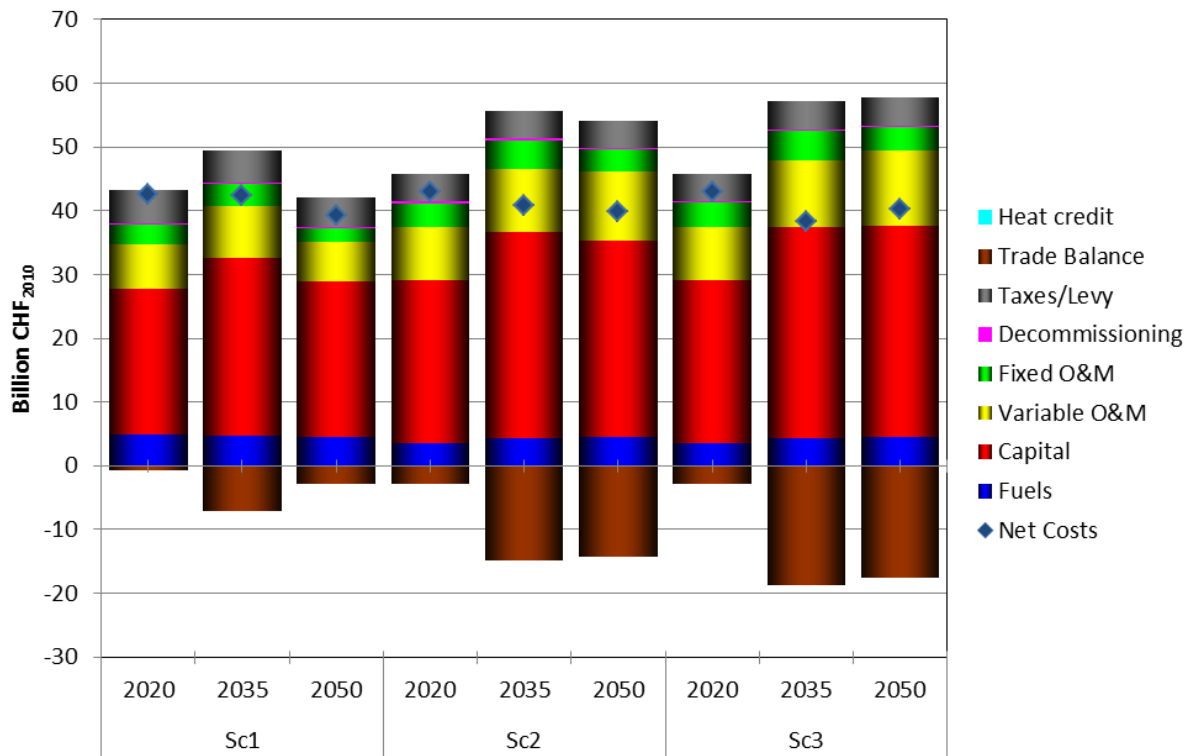

Figure B 3: Undiscounted system costs - France

1.2 Germany

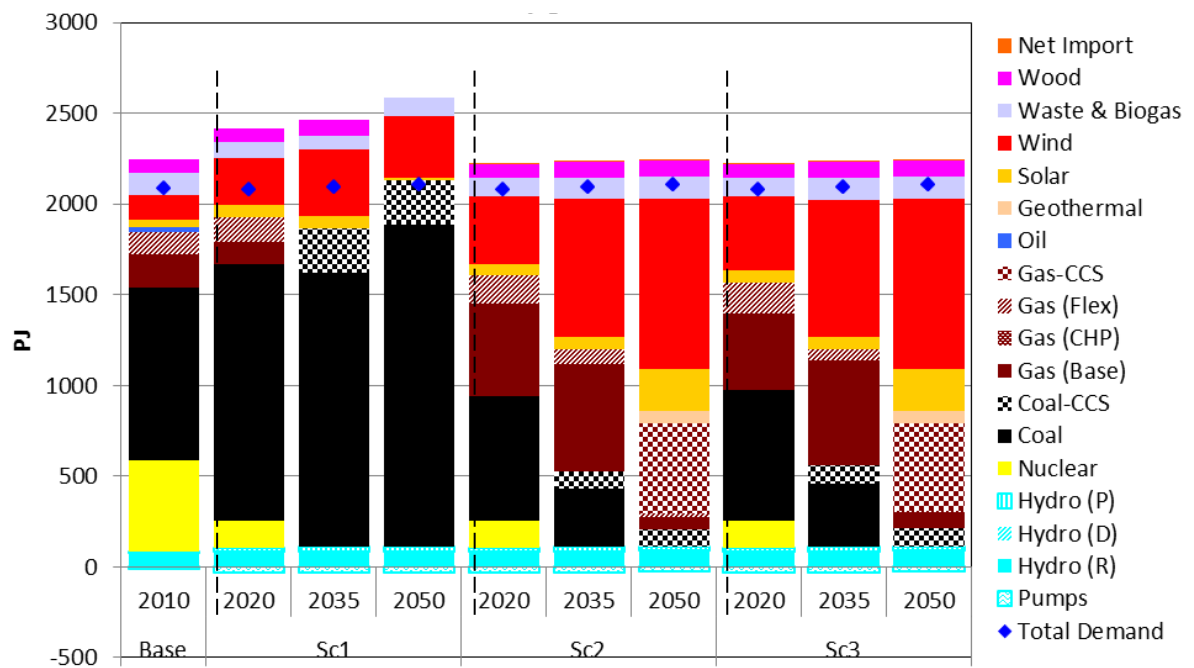

Figure B 4: Electricity generation mix - Germany

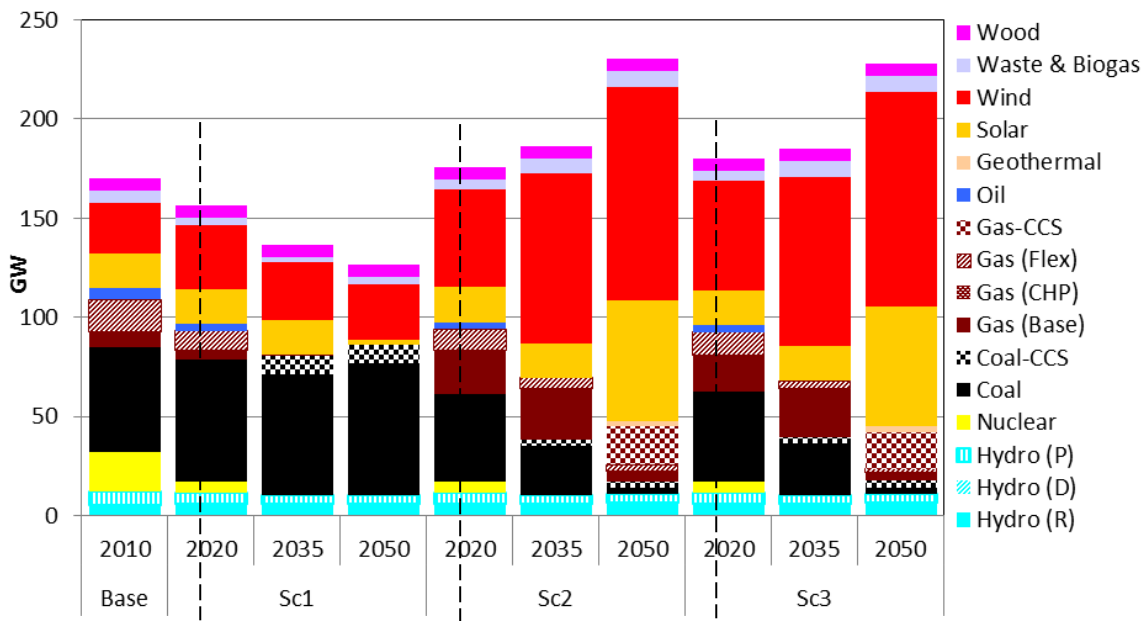

Figure B 5: Installed capacity - Germany

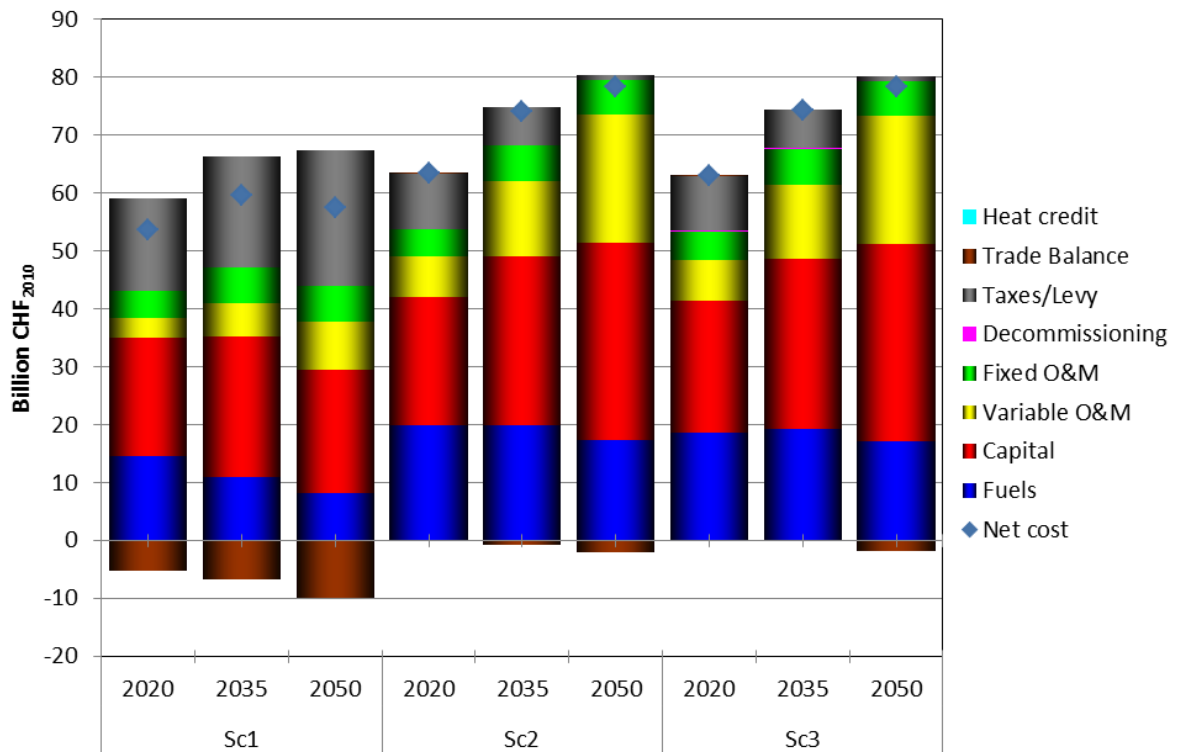

Figure B 6: Undiscounted system costs - Germany

1.3 Italy

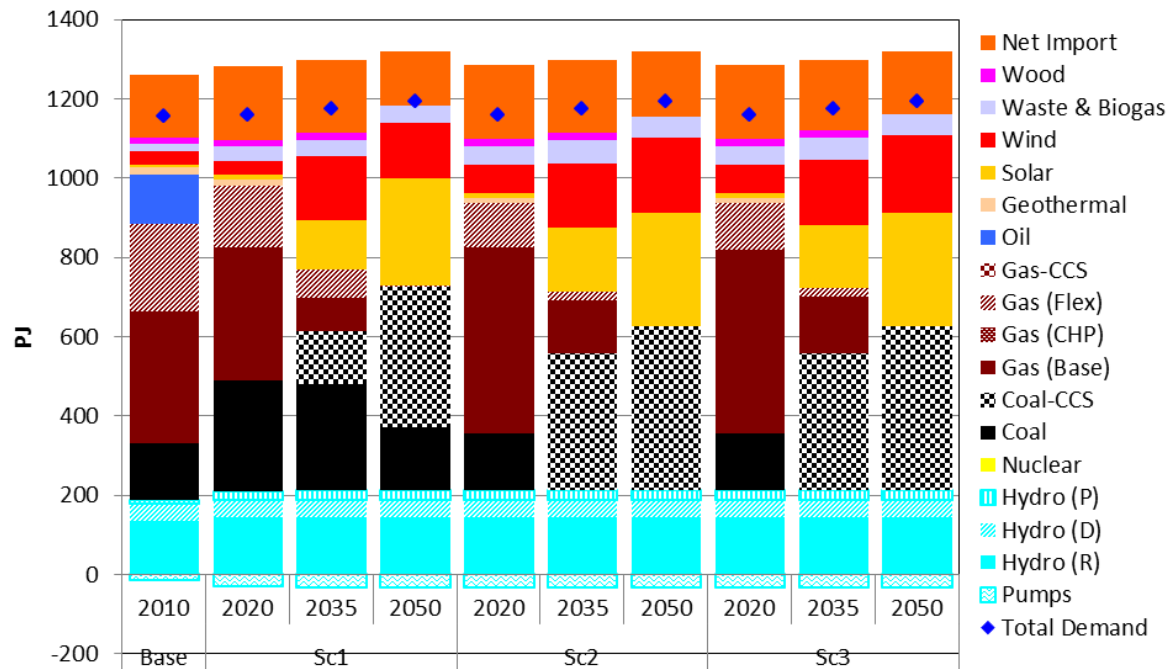

Figure B 7: Electricity generation mix - Italy

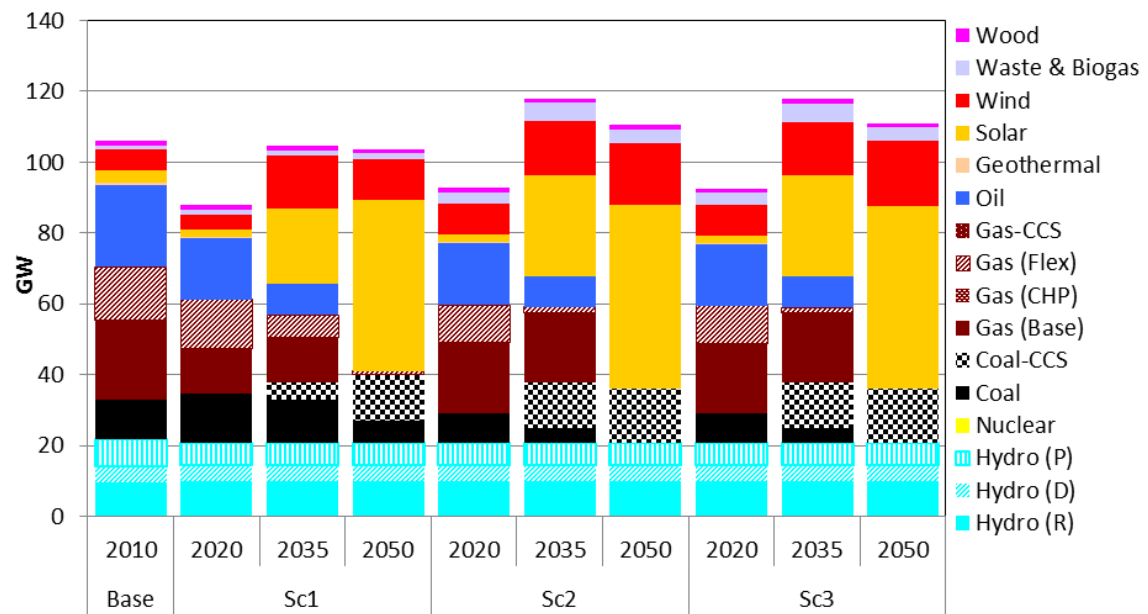

Figure B 8: Installed capacity - Italy

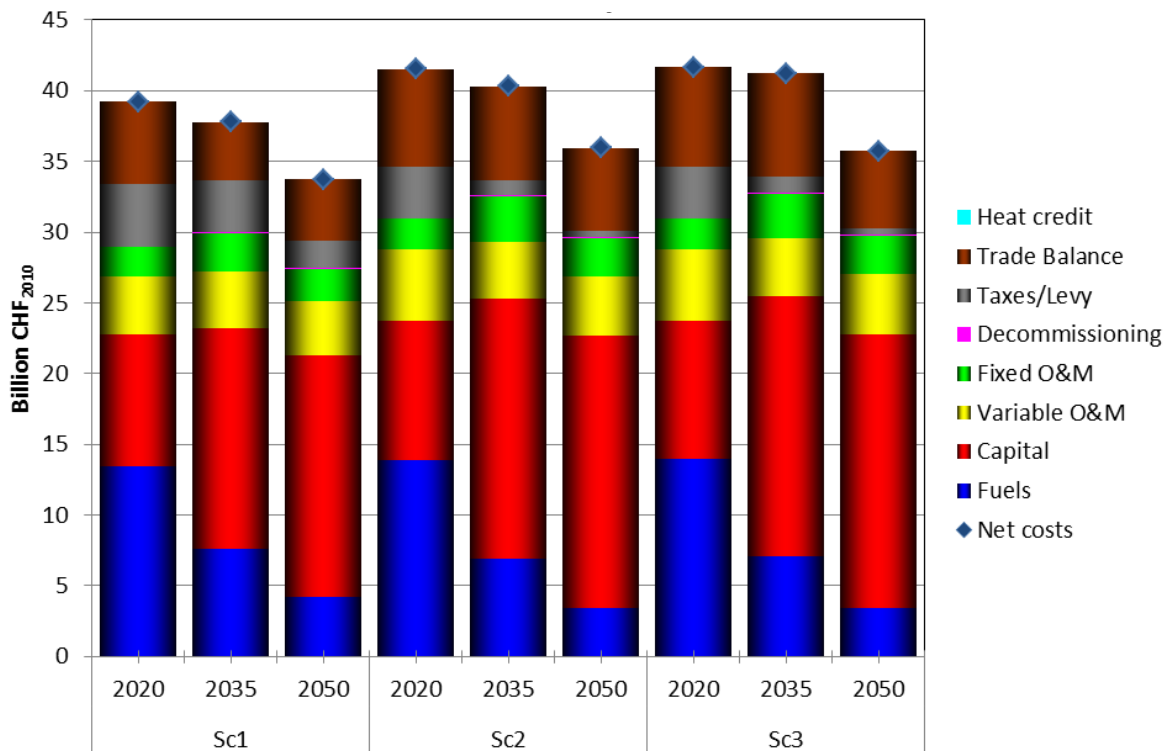

Figure B 9: Undiscounted system costs - Italy

1.4 Austria

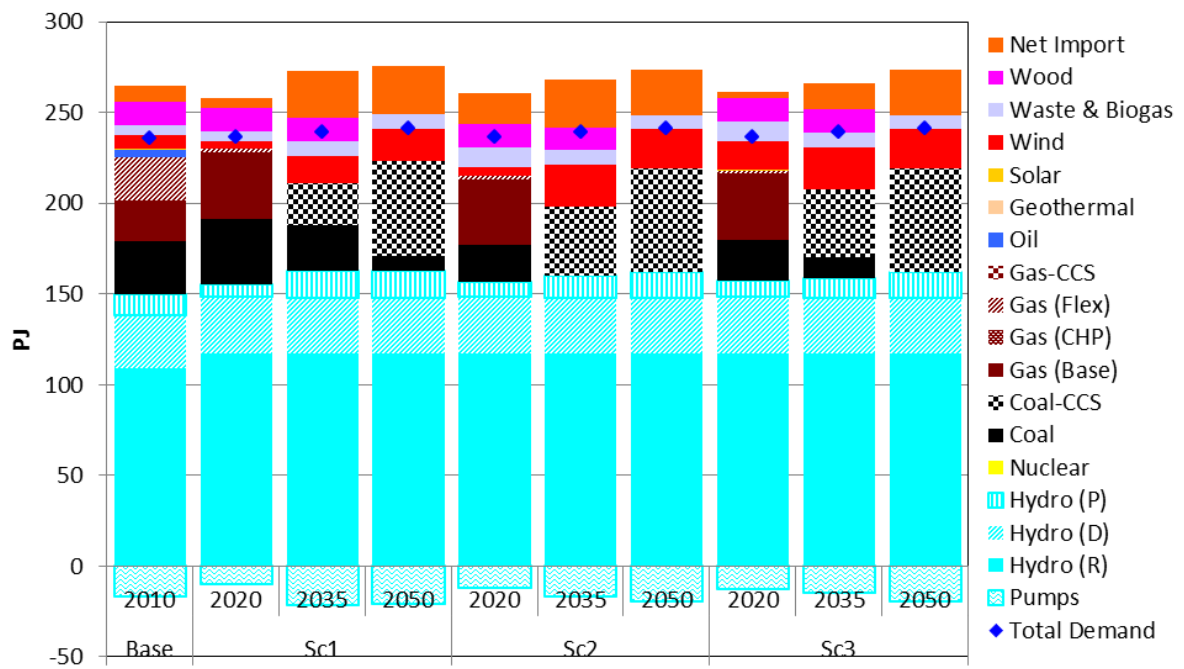

Figure B 10: Electricity generation mix - Austria

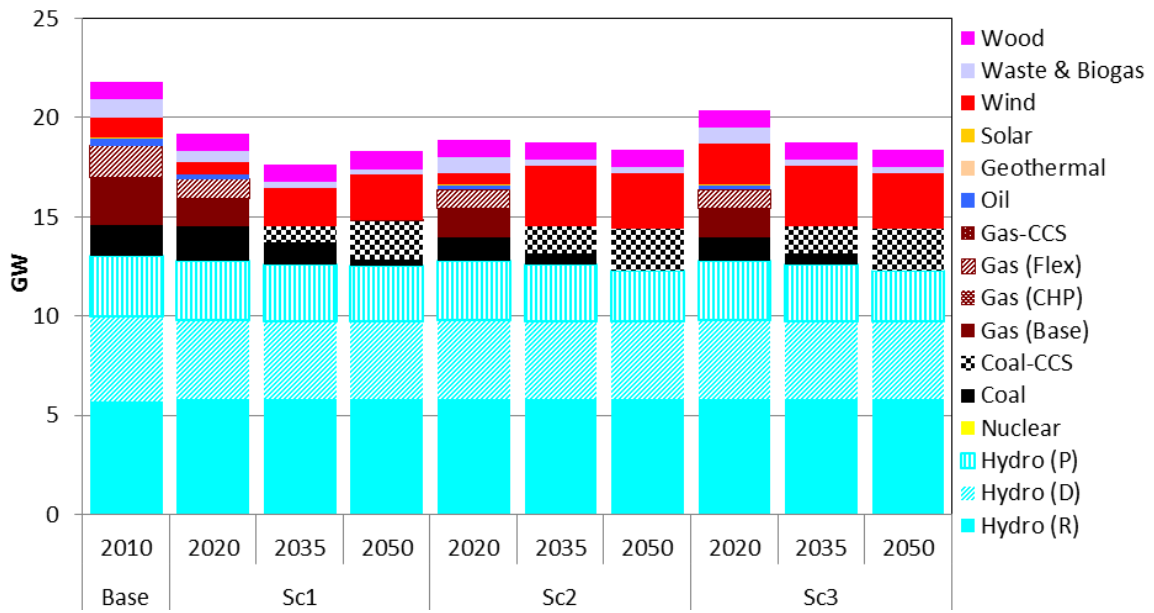

Figure B 11: Installed capacity - Austria

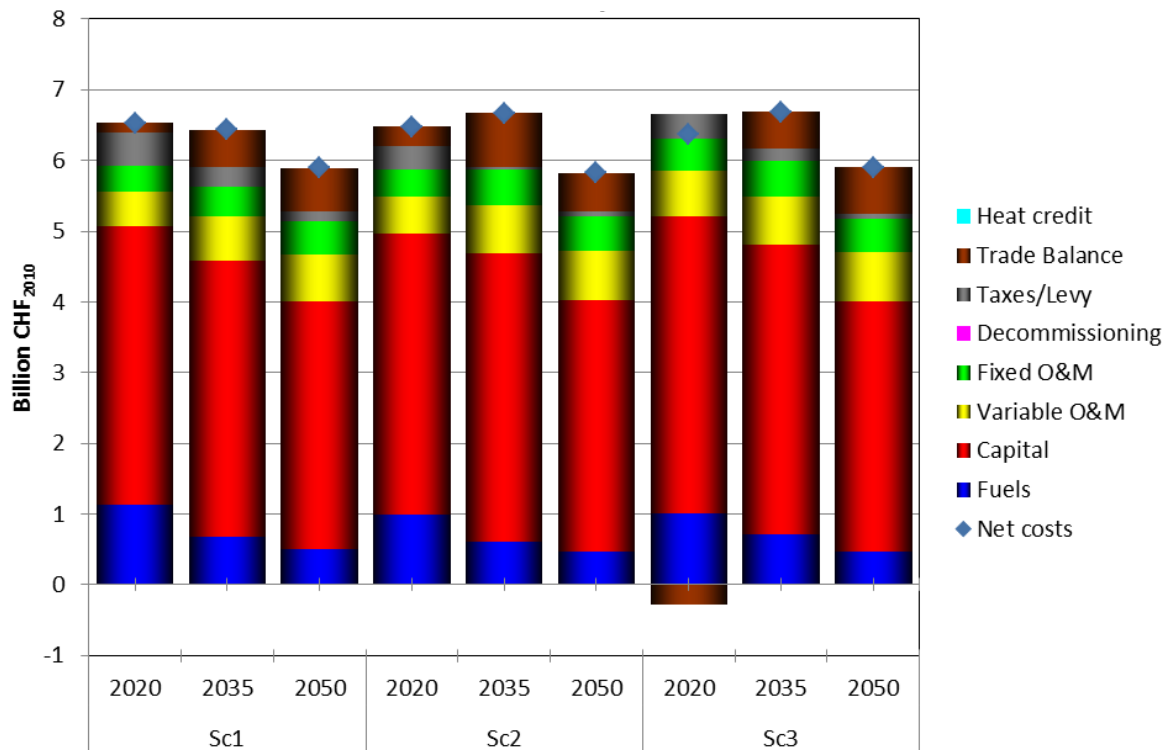

Figure B 12: Undiscounted system costs - Austria

2 Generation Schedules

2.1 Scenario 1

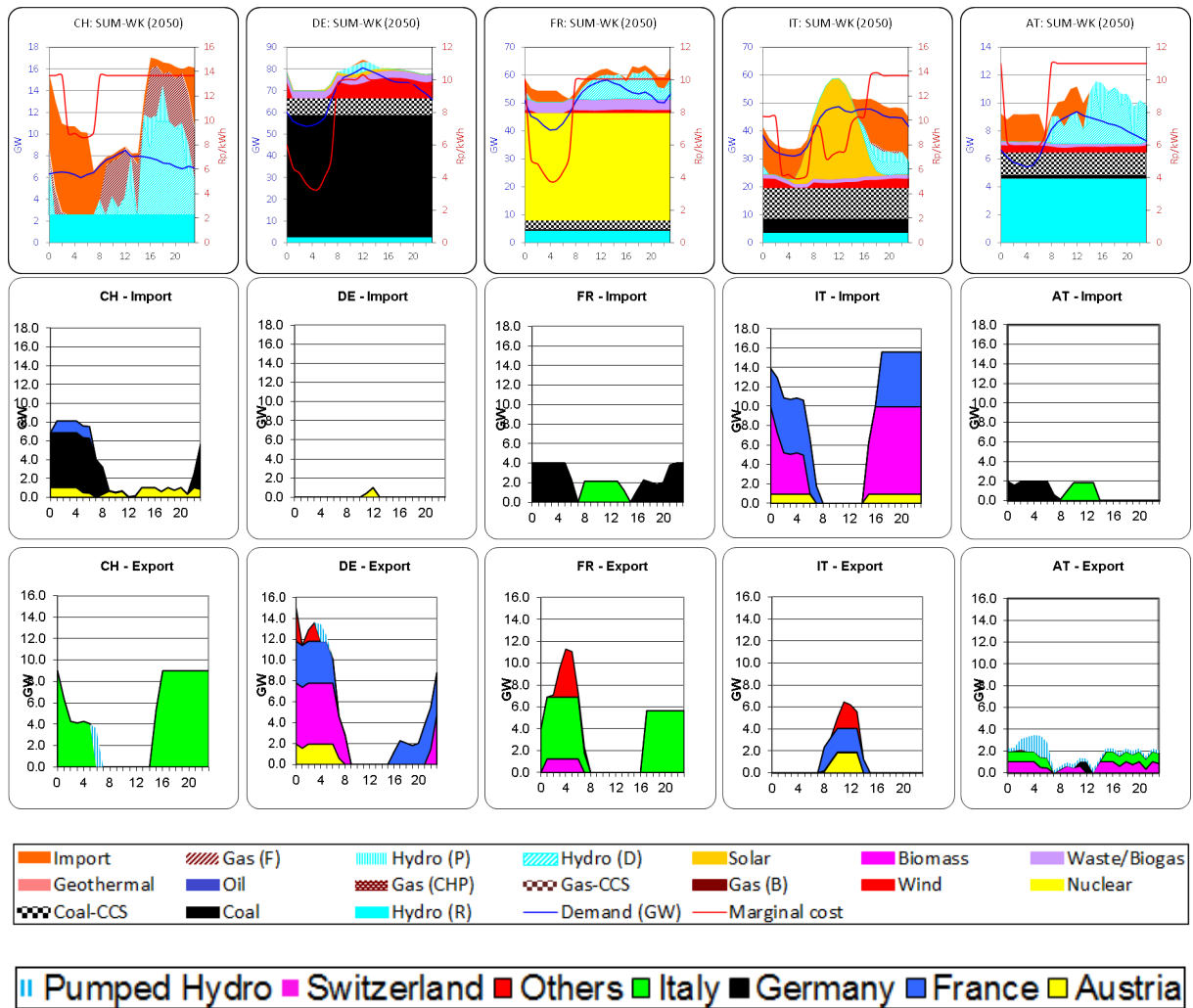
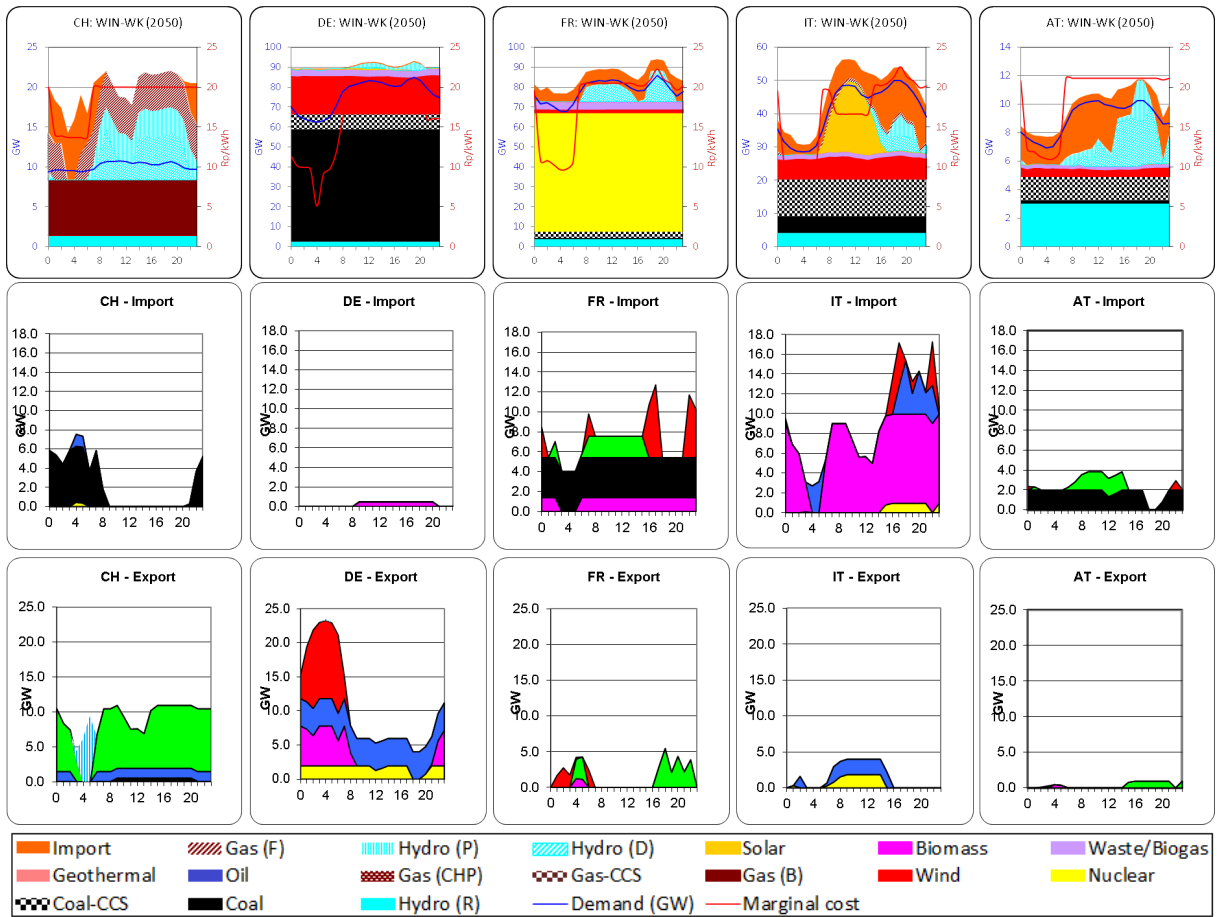

Figure B 13: Electricity generation schedules for all countries on a summer weekday 2050 (Sc1)



|| Pumped Hydro || Switzerland || Others || Italy || Germany || France || Austria

Figure B 14: Electricity generation schedules for all countries on a winter weekday 2050 (Sc1)

2.2 Scenario 2

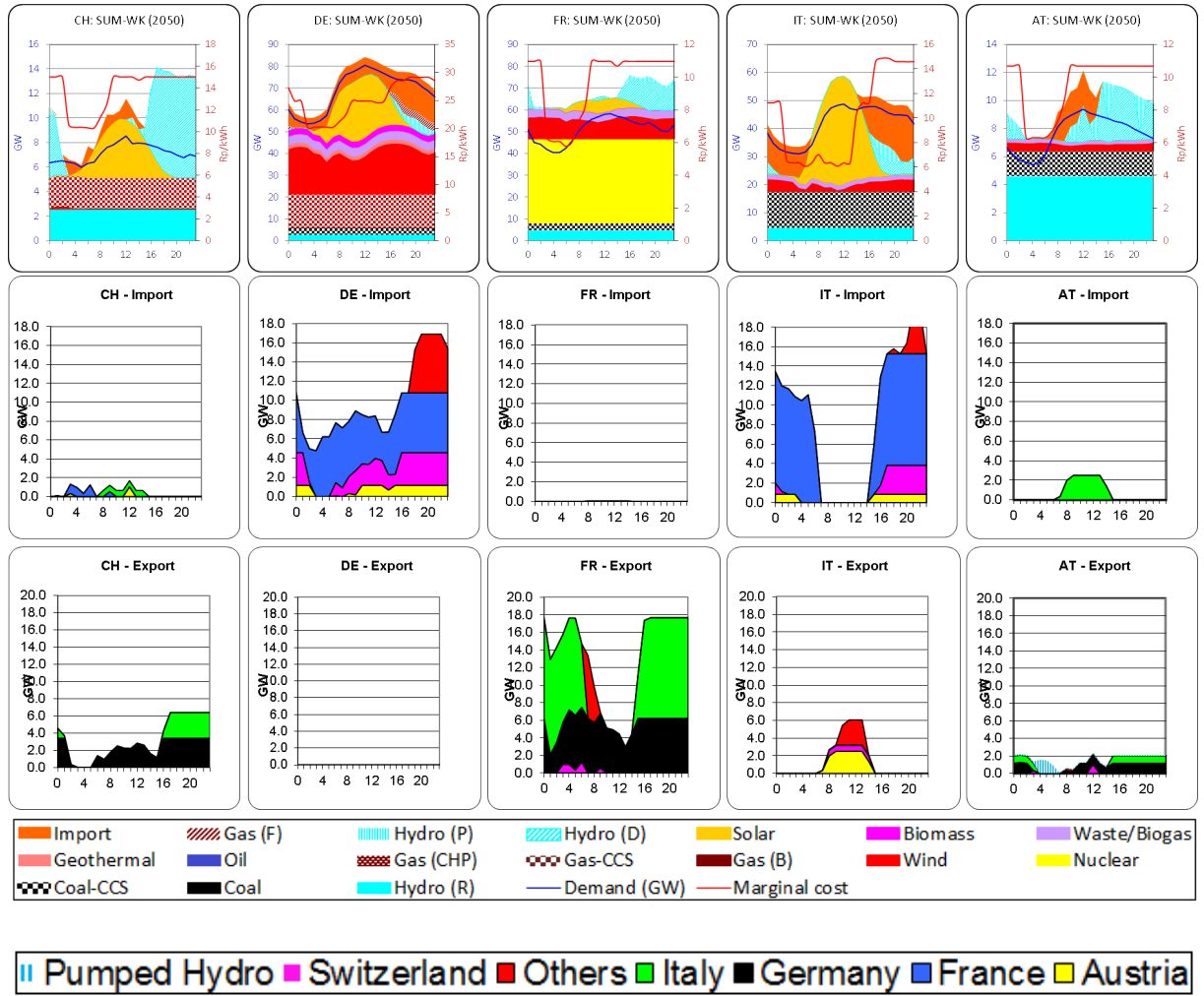

Figure B 15: Electricity generation schedules for all countries on a summer weekday 2050 (Sc2)

2.3 Scenario 3

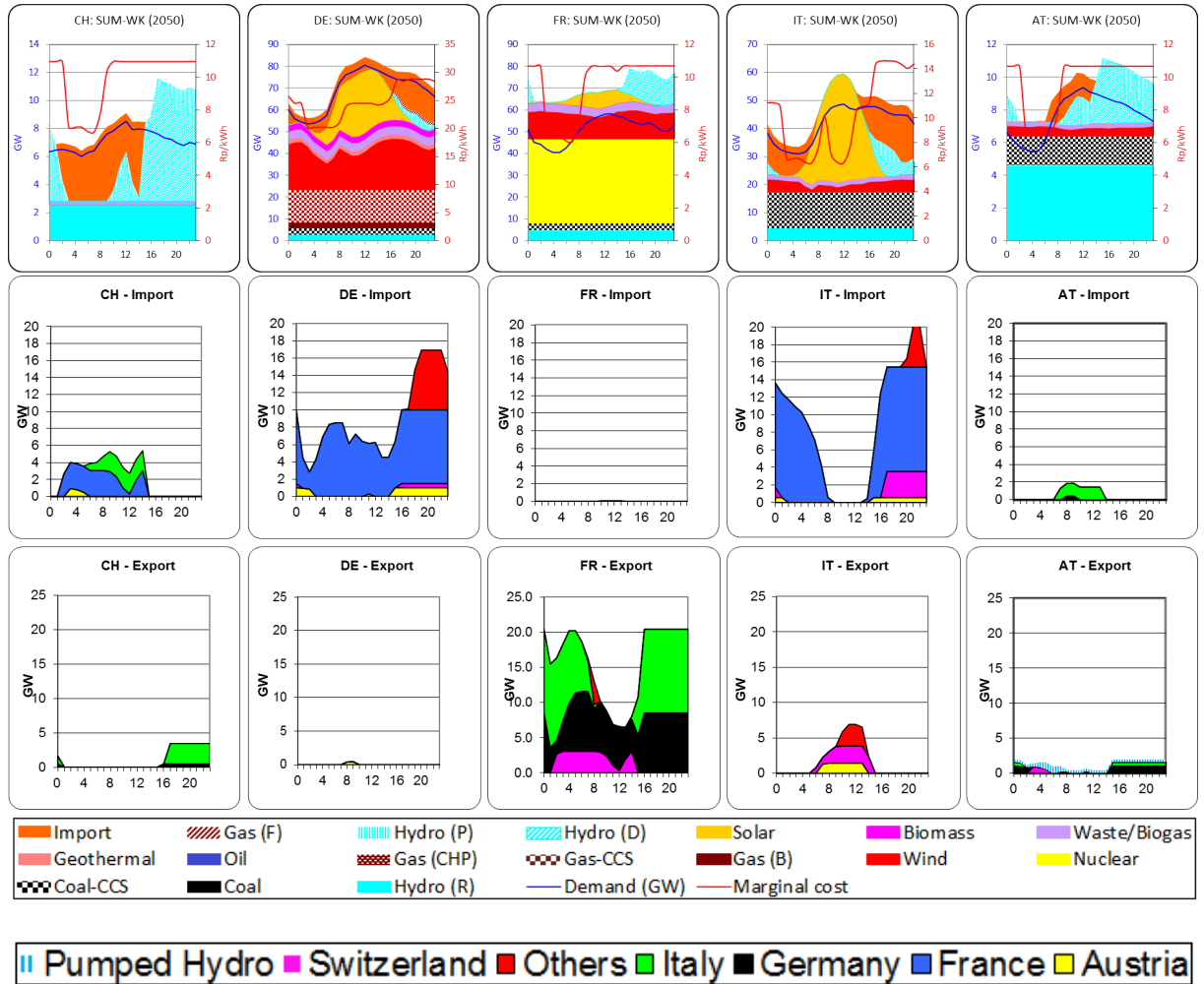

Figure B 16: Electricity generation schedules for all countries on a summer weekday 2050 (Sc3)

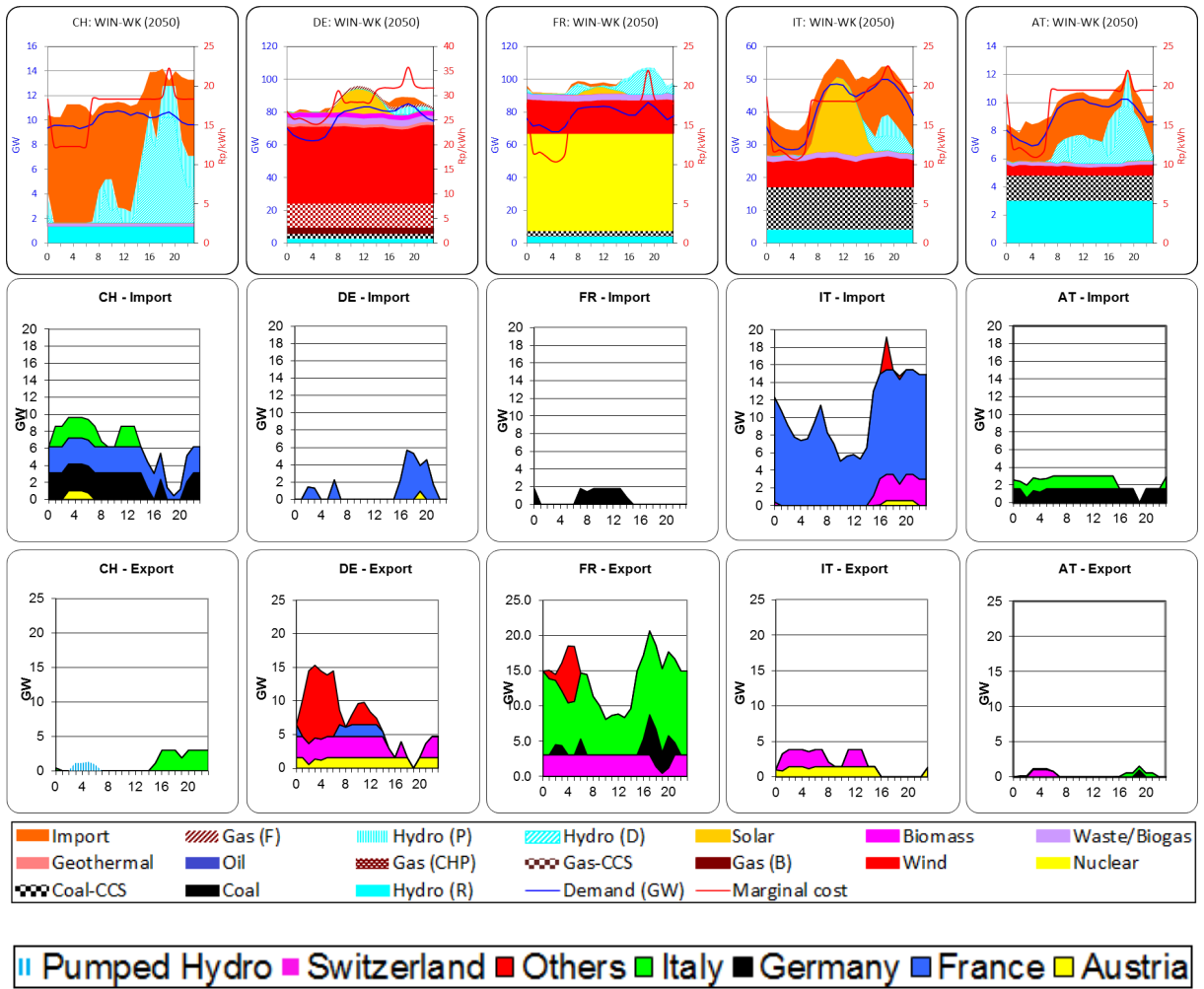

Figure B 17: Electricity generation schedules for all countries on a winter weekday 2050 (Sc3)

Appendix C – CROSSTEM-CH results in the coupled ELECTRA-CH framework

1 Generation schedule – comparison between three scenarios

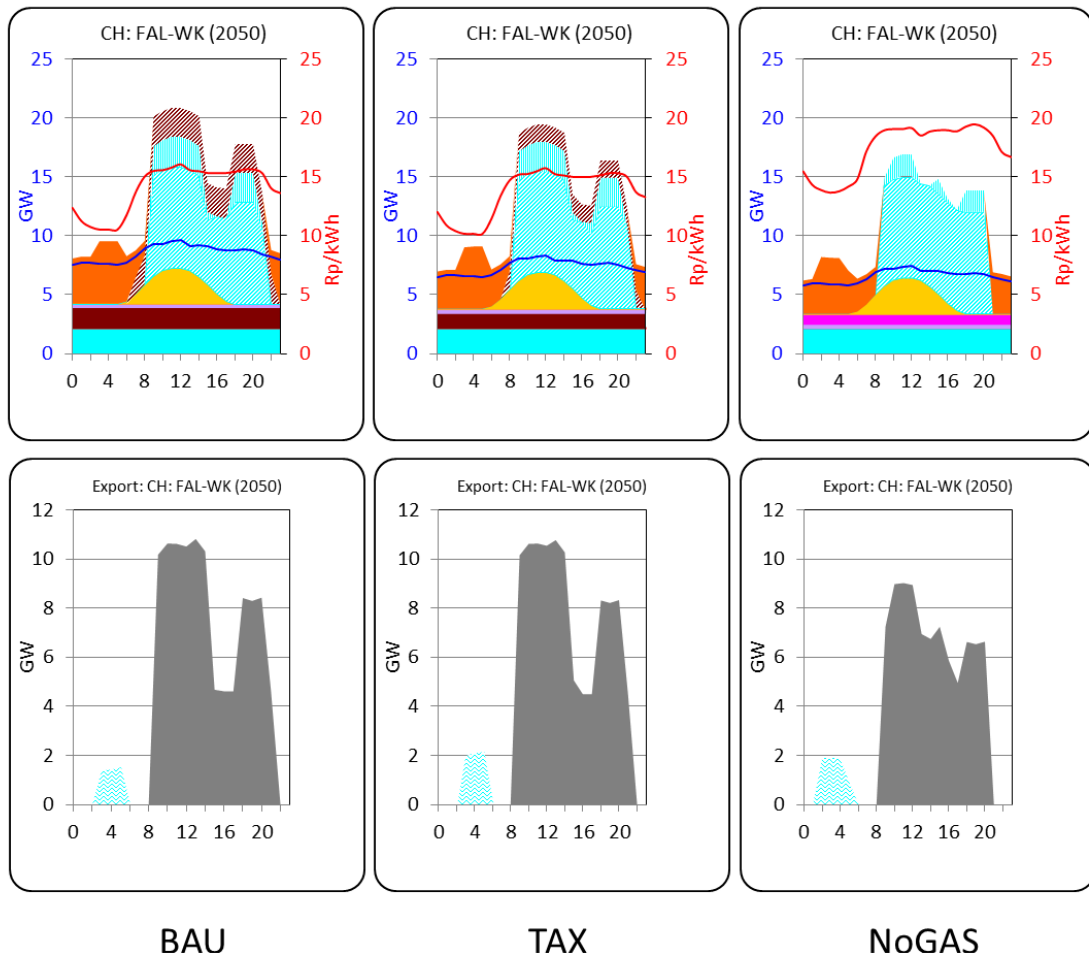

Figure C 1: Electricity generation schedule on a fall weekday (2050)

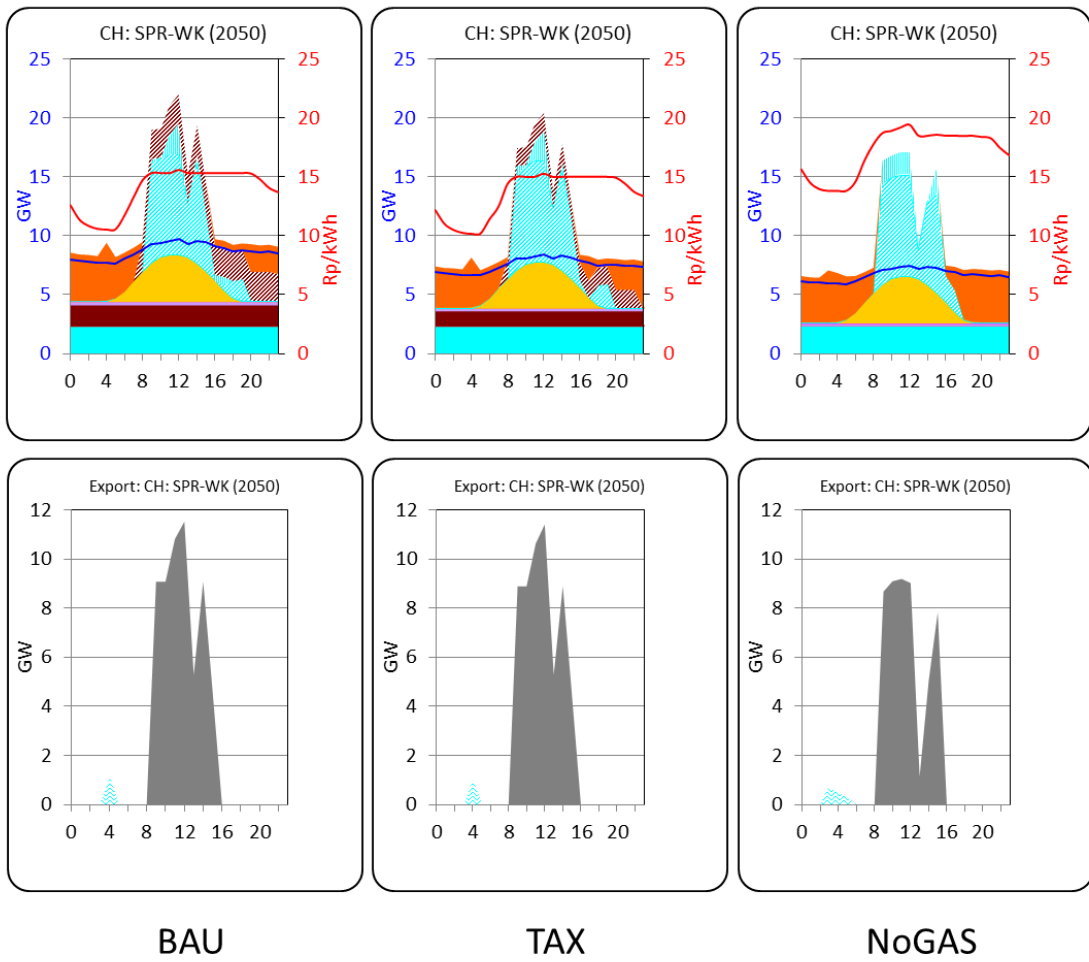

Figure C 2: Electricity generation schedule on a spring weekday (2050)

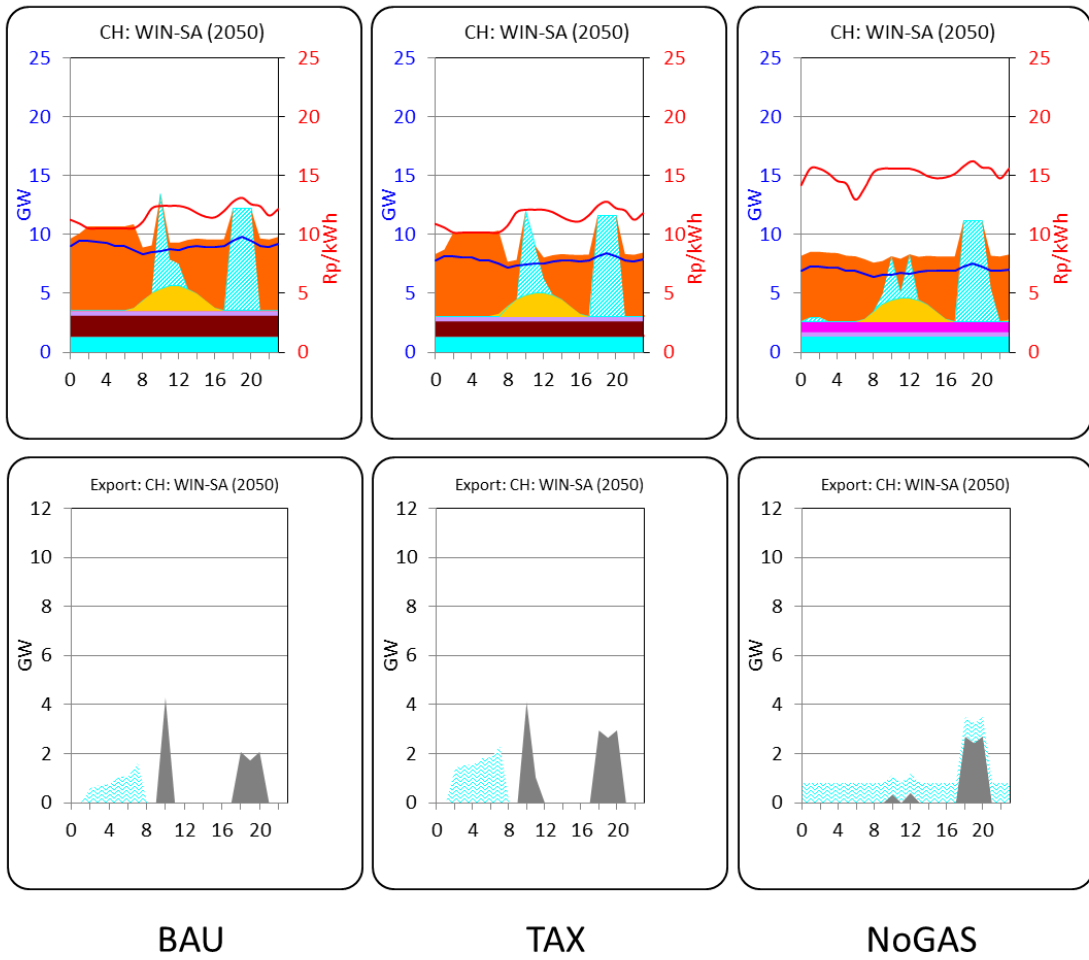

Figure C 3: Electricity generation schedule on a winter Sunday (2050)

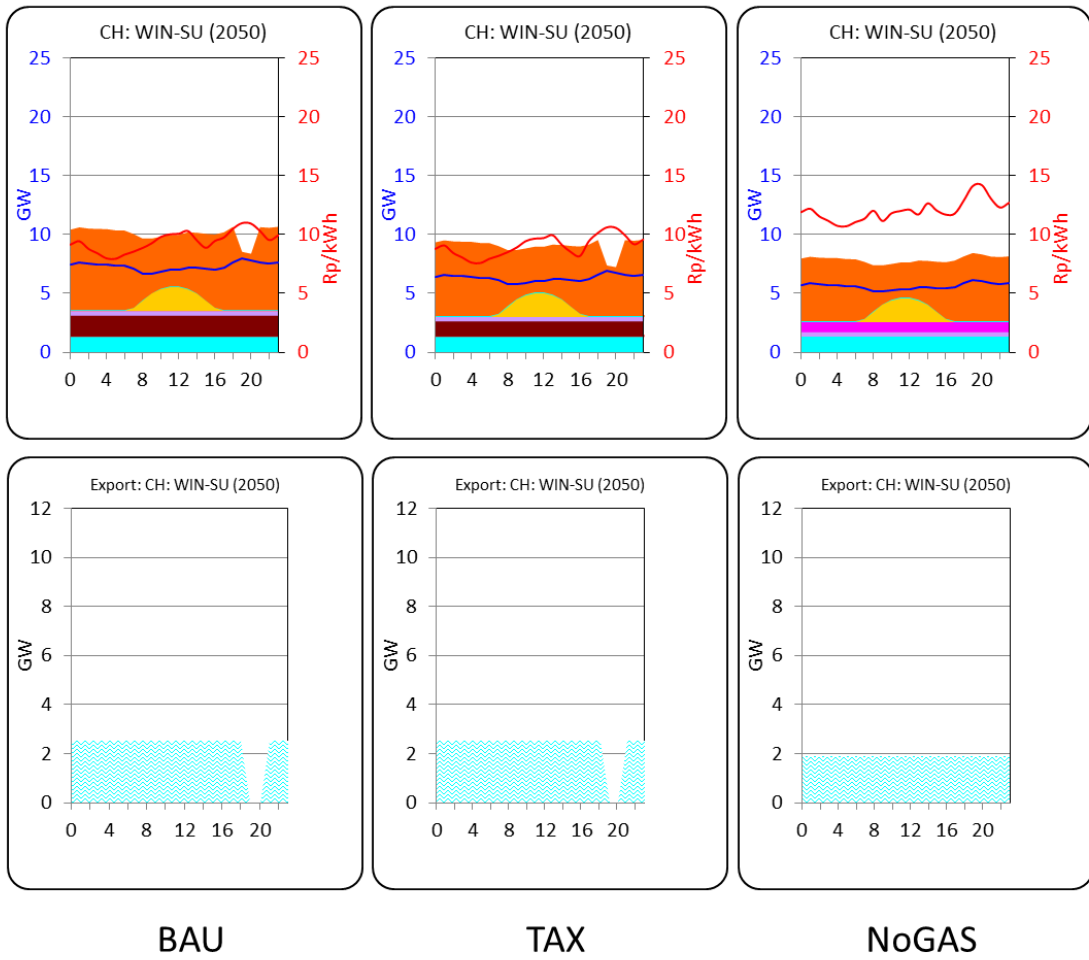

Figure C 4: Electricity generation schedule on a winter Saturday (2050)